



Aastra Business Communication Systems



System functions and features as of R2.0 System Manual

Platforms supported:

Aastra 415

Aastra 430

Aastra 470

This document describes the system functions and features of communication servers of the Aastra 400 series.

It is intended for planners, installers and system managers of Aastra 400 communication systems.

Content

1	Product and Safety Information	12
1.1	Product information	12
1.2	Safety information	14
1.3	Data Protection	15
1.4	About this System Manual	16
1.5	About Aastra	18
2	System interfaces	19
2.1	Network Interfaces	20
2.1.1	Basic Access Variants	20
2.1.1.1	Basic rate interface BRI-T	21
2.1.1.2	BRI-S basic rate interface external	21
2.1.1.3	Point-to-Point and Point-to-Multipoint Connections	22
2.1.2	Primary rate interface PRI	26
2.1.2.1	Clock synchronization	27
2.1.2.2	Digital down-circuit connection with QSIG	27
2.1.2.3	Direct Dialling Out (DDO)	28
2.1.3	SIP access	29
2.1.4	Analogue Network Interfaces	32
2.1.4.1	Analogue down-circuit connection	34
2.1.4.2	Attenuation on analogue network interfaces	36
2.2	Terminal interfaces	36
2.2.1	Digital user-network interfaces	36
2.2.1.1	Terminal interface BRI-S	37
2.2.1.2	DSI terminal interfaces	38
2.2.1.3	IP terminal interface	39
2.2.2	Analogue terminal interfaces	40
2.3	Special Interfaces	41
2.3.1	Ethernet interfaces	41
2.3.2	Interface for door intercom system	41
2.3.3	Interface for general bell	42
3	Numbering plan	43
3.1	Numbering Plan Identifiers	43
3.2	The System's Numbering Plan	45
3.2.1	Categories in the Numbering Plan	46
3.2.2	Exchange Access Categories	48
3.2.3	Category for abbreviated dialling	48

3.2.4	Category for emergency number	50
3.2.5	Category for internal users	51
3.2.5.1	Internal users.	51
3.2.5.2	Mobile phones.	52
3.2.5.3	Aastra Mobile Client (AMC)	56
3.2.5.4	Virtual terminals	59
3.2.6	PISN users	60
3.2.7	Separate Regional Prefix Category	64
3.2.8	Shared Numbering Plan	64
3.2.9	PISN with different Regions	65
4	Identification elements	67
4.1	Internal and External Ringing Patterns	67
4.2	Displaying Numbers (CLIP) and Names (CNIP)	69
4.2.1	Displaying the CLIP	71
4.3	CLIP with Incoming Calls	72
4.3.1	Analysing and Editing the CLIP	72
4.3.2	Presentation of the CLIP on the Terminal	73
4.3.3	Replicating the Name Display in the Communication Server	74
4.3.4	Flow charts for name identification (CNIP)	75
4.4	CLIP with Outgoing Calls	76
4.4.1	Creating the CLIP in the communication server	77
4.4.2	Entering a fixed CLIP	77
4.4.3	Suppressing CLIP / COLP (CLIR / COLR)	77
4.4.4	CLIP flowcharts for Outgoing Calls	78
4.4.5	CLIP Display with a Virtual Network PISN User	80
4.5	Display for Call Forwarding Unconditional	81
4.5.1	Information displayed to the called user	81
4.5.1.1	Outgoing call with local call forwarding	81
4.5.1.2	Incoming call with CDE overflow	82
4.5.1.3	Incoming call that is already redirected	82
4.5.2	Information displayed to the calling user	83
4.5.2.1	Incoming call with local call forwarding	83
4.5.2.2	Incoming call with CDE overflow	84
4.5.2.3	Outgoing call with non-local redirection	84
4.6	CLIP / COLP Settings	84
4.6.1	User	86
4.6.2	PISN users	87
4.6.3	Trunk groups	88
4.6.4	CLIP/CLIR settings	89
4.6.5	Numbering plan	90
4.7	Examples of CLIP Displays in the PISN	90

4. 7. 1	PISN-Internal Calls	92
4. 7. 2	Outgoing Calls to the Public Network	94
4. 7. 3	Incoming calls from the public network	97
4. 7. 4	CLIP format for transit connections in networks.....	100
4. 8	CLIP on analogue exchange accesses.....	101
5	Routing elements	102
5. 1	Overview	102
5. 2	Trunk groups	106
5. 2. 1	Trunk Groups of Network Interfaces	107
5. 2. 2	Routing Functions of the Trunk Group for Incoming Calls	109
5. 2. 3	Trunk Group Identification Functions.....	110
5. 2. 4	Other Trunk Group Functions and Settings	110
5. 3	Route	113
5. 3. 1	The Route's Routing Functions	114
5. 3. 2	Routing an Outgoing Call to a Trunk Group.....	114
5. 3. 3	Other Routing Functions for Outgoing Calls	116
5. 4	Direct Dialling Plan (DDI plan).....	118
5. 5	Call Distribution Element (CDE)	121
5. 5. 1	Call destination.....	122
5. 5. 2	Routing Functions for Incoming Calls.....	127
5. 5. 3	Routing Functions for Outgoing Calls	128
5. 5. 4	Other Functions and Settings of the CDE	128
5. 6	Switch Groups.....	129
5. 7	User Group	132
5. 7. 1	Ordinary user groups	133
5. 7. 1. 1	Elements of a User Group	133
5. 7. 1. 2	Call distribution in the member group.....	134
5. 7. 2	Large user groups	140
5. 7. 3	User Groups for Voice Mail and Other Applications	140
5. 7. 3. 1	User Groups 14, 15 and 16	141
5. 7. 3. 2	User group 14, 15 and 16	142
5. 7. 3. 3	User groups 30 - 99	142
5. 7. 3. 4	Application example for a user group	142
5. 8	User Configuration	143
5. 8. 1	Routing Functions for Incoming Calls.....	143
5. 8. 2	Routing Functions for Outgoing Calls	144
5. 9	Operator console	145
5. 9. 1	Routing Functions for Incoming Calls.....	146
5. 9. 2	Routing Functions for Outgoing Calls	147
5. 9. 3	Two-company system	147
5. 9. 4	Capolinea	149

5. 10	General bell.....	150
5. 11	Key telephones	150
5. 11. 1	Using Terminals as Key Telephones.....	151
5. 11. 2	KT lines and Line Keys.....	152
5. 11. 3	Incoming Calls via a KT Line	154
5. 11. 4	Outgoing Calls via a KT Line	156
5. 11. 4. 1	Application Examples for Key Telephones	157
5. 11. 4. 2	Destination KT	158
5. 12	ACD Server	160
6	Call routing	163
6. 1	Overview	163
6. 2	Internal traffic.....	163
6. 2. 1	Internal Destinations.....	163
6. 2. 2	Dialling internal destinations via external call numbers.....	164
6. 2. 3	Internal Digit Barring.....	167
6. 2. 4	Internal ringing duration	167
6. 3	Incoming Traffic	168
6. 3. 1	Routing.....	168
6. 3. 1. 1	Call from the Public Network	170
6. 3. 1. 2	Call from the Private Leased-Line Network.....	173
6. 3. 1. 3	Personal call routing	176
6. 3. 2	Call Forwarding Unconditional if no answer.....	176
6. 3. 2. 1	CDE Alternative Destinations.....	176
6. 3. 2. 2	Default forwarding per user	176
6. 3. 3	Response if busy.....	178
6. 3. 3. 1	Response if the call destination is busy	179
6. 3. 3. 2	Forwarding a call if busy	182
6. 3. 3. 3	Not Forwarding a Call if busy	183
6. 3. 3. 4	Release Destination if Incoming Dialling is Incomplete	183
6. 3. 4	Response if unobtainable	184
6. 3. 5	Emergency Routing	186
6. 3. 5. 1	Routing if the Call Destination is busy.....	186
6. 3. 5. 2	Release Destination if Dialling is Incomplete	187
6. 4	Automatic reject of collect calls.....	188
6. 5	Outgoing traffic.....	190
6. 5. 1	Routing.....	190
6. 5. 2	Digit barring	191
6. 5. 3	Call to the Public Network.....	195
6. 5. 3. 1	Routing the call.....	197
6. 5. 3. 2	Call to the public Network via a Key Telephone	198
6. 5. 3. 3	Call to the public Network via an operator console	200

6. 5. 3. 4	Call to a virtual Network PISN User	200
6. 5. 3. 5	Exchange access.....	201
6. 5. 3. 6	Priority exchange allocation.....	202
6. 5. 4	Call to the private Leased-Line Network	204
6. 5. 5	Call to a DSS1 Terminal equipment on the S Bus (DDO)	205
6. 6	Least Cost Routing (LCR)	206
6. 6. 1	Direct or indirect Selection of the Network Provider.....	207
6. 6. 2	LCR function.....	208
6. 6. 3	Allocating the Internal Routing Table (LCR Table)	210
6. 6. 4	Selecting the Network Provider (Routing Tables).....	213
6. 6. 4. 1	Time zones	215
6. 6. 4. 2	Alternative Routing (Fallback Routing)	215
6. 6. 4. 3	Restricted scope of performance by a Network Provider	216
6. 6. 5	Conversion and Routing (Network Provider Table)	216
6. 6. 6	Bypassing LCR manually (Forced Routing)	219
6. 6. 7	LCR with Key Telephones	220
6. 6. 8	LCR in the private Leased-line Network.....	220
6. 6. 9	Call logging and Data Protection	221
6. 6. 10	Examples of LCR	221
6. 6. 11	Higher-Level LCR Settings.....	223
6. 7	Exchange-to-Exchange Connection	223
6. 7. 1	Exchange-to-Exchange Connections	223
6. 7. 1. 1	Setting up Exchange-to-Exchange Connections	225
6. 7. 1. 2	Clearing down Exchange-to-Exchange Connections	225
6. 7. 1. 3	Possible Exchange-to-Exchange Connections.....	228
6. 7. 2	Transferring Call Forwarding Unconditional to the Exchange....	231
6. 7. 3	Three-Party Connections in the Exchange	234
6. 8	Transit Routing in the Private Leased-Line Network	237
6. 8. 1	From the Public Network to the Private Leased-Line Network ...	238
6. 8. 2	From the private leased-line network into the public network...	241
6. 8. 3	From the private leased-line network into the private leased- line network.....	245
6. 9	Testing overflow routing in the PISN	246
6. 9. 1	Overflow routing within the private leased-line network.....	247
6. 9. 2	Overflow routing via the public network	248
6. 10	Break-Out	251
7	Data service	255
7. 1	Overview	255
7. 2	Data-service connections and destination tables.....	256
7. 3	Routing in the private leased-line network.....	260
7. 4	User-to-user signalling (UUS).....	262

8	Call logging (CL)	263
8.1	Overview	263
8.2	Individual charge counting or ICC	266
8.2.1	Cumulative counter	266
8.2.2	Surcharge calculator	269
8.2.3	ICC reports	269
8.3	Call logging for outgoing calls (OCL)	273
8.3.1	General OCL settings	274
8.3.2	Surcharge calculator	275
8.3.3	Data protection	278
8.3.4	Cost centres	278
8.3.5	Charge management	280
8.4	Call logging for incoming calls (ICL)	280
8.5	Call data output	283
8.5.1	Output types	283
8.6	Printer faults	285
8.7	Output formats	286
8.7.1	Structure of the PC5 output format	286
8.7.2	Data fields of the PC format	288
8.7.2.1	Explanation of the data fields	289
8.7.3	Examples of the PC5 output on a stand-alone communication server	297
8.7.3.1	Outgoing calls to the public network	297
8.7.3.2	Incoming calls from the public network	298
8.7.4	Examples of PC5 output in a PISN	303
8.7.5	Protocol format	308
8.7.6	Individual receipt format	311
8.7.7	Output formats PC1 to PC4	312
8.7.7.1	PC1 format	315
8.7.7.2	PC2 format	316
8.7.7.3	PC3 format	317
8.7.7.4	PC4 format	318
9	Features	320
9.1	Overview	320
9.1.1	Description categories and terminology	321
9.1.2	Information about the system phones	322
9.1.3	Terminology	322
9.2	Network services, authorizations and operation	323
9.2.1	ISDN services supported by the system	323
9.2.1.1	External services and internal features	323
9.2.1.2	ISDN supplementary services supported	325

9. 2. 2	Notifications supported by the system	326
9. 2. 3	SIP-RFC supported by Aastra 400.....	327
9. 2. 4	Features in the private network	328
9. 2. 4. 1	Networking with QSIG	328
9. 2. 4. 2	Virtual Networking in the ISDN Network.....	329
9. 2. 5	Features in the up-circuit communication server.....	330
9. 2. 6	Features operated via QSIG	330
9. 2. 6. 1	User-unrelated features.....	330
9. 2. 6. 2	User-related features	331
9. 2. 7	User-related authorizations	331
9. 2. 8	Exchange access authorizations.....	332
9. 2. 9	Operating the features on the terminal.....	332
9. 2. 9. 1	Feature activation	332
9. 2. 9. 2	Configurable keys	333
9. 2. 10	Languages supported	335
9. 3	One Number user concept	337
9. 4	Call Forwarding Unconditional functions	339
9. 4. 1	Call Forwarding Unconditional (CFU).....	339
9. 4. 1. 1	Call Forwarding Unconditional to exchange	342
9. 4. 1. 2	Wait for connection setting	343
9. 4. 1. 3	Examples of Call Forwarding Unconditional	343
9. 4. 2	Follow me.....	345
9. 4. 3	Call Forwarding on No Reply (CFNR).....	346
9. 4. 4	Deflecting a call during the ringing phase (CD)	349
9. 4. 5	Reject call	351
9. 4. 6	Twin Mode / Twin Comfort.....	352
9. 4. 7	Do not disturb.....	354
9. 4. 8	Substitution	355
9. 4. 9	DECT Follow Me	357
9. 4. 9. 1	DECT Follow Me in a Network with 2, 3 or 4 Systems	357
9. 4. 10	Organising absences on the workstation	359
9. 5	Connections involving several users.....	362
9. 5. 1	Music on hold	362
9. 5. 2	Hold (enquiry call)	365
9. 5. 3	Enquiry call with return to initial call.....	367
9. 5. 4	Brokering (switching back and forth between two calls).....	368
9. 5. 5	Three-party conference from an enquiry call.....	369
9. 5. 6	Conference.....	371
9. 5. 7	Call transfer (switching).....	373
9. 5. 7. 1	Call transfer with prior notice	373
9. 5. 7. 2	Call transfer without prior notice	375

9.5.7.3	Call transfer if busy.....	376
9.5.8	Recall.....	379
9.5.9	Call acceptance.....	381
9.6	Added features.....	382
9.6.1	Voice mail system.....	382
9.6.1.1	Overview.....	382
9.6.1.2	Voice memory capacity and voice channels.....	383
9.6.1.3	Operation of the voice mail functions.....	384
9.6.1.4	Recording greetings with the PC and uploading them onto the communication system.....	385
9.6.1.5	Audio guide.....	386
9.6.1.6	Auto-Attendant.....	387
9.6.1.7	Scope.....	390
9.6.1.8	Access concept.....	392
9.6.1.9	System configuration.....	392
9.6.1.10	Functions in prefix dialling.....	395
9.6.1.11	Suffix dialling functions.....	397
9.6.2	Dialling by name.....	398
9.6.3	End-of-selection signal.....	399
9.6.4	Call waiting.....	400
9.6.5	intrusion.....	402
9.6.6	Silent intrusion.....	404
9.6.7	Announcement to one or more users.....	407
9.6.8	Charge recall.....	410
9.6.9	Intercom.....	412
9.6.10	Picking up a call.....	413
9.6.11	Hotline.....	414
9.6.12	Sending and reading text messages.....	416
9.6.13	Message function.....	418
9.6.14	Leave message.....	420
9.6.15	Standard texts.....	421
9.6.16	Park.....	423
9.6.16.1	Local call parking.....	423
9.6.16.2	Central call parking.....	424
9.6.16.3	Call parking function of the key telephone.....	426
9.6.16.4	Call parking function on the operator console.....	426
9.6.17	Callback if user busy / free.....	427
9.6.17.1	Callback if user busy.....	427
9.6.17.2	Callback to free user.....	429
9.6.17.3	Wait until free.....	431
9.6.18	Team functions.....	432

9. 6. 19	Locking and unlocking terminals	433
9. 6. 19. 1	Locking / unlocking terminals (telephone lock)	434
9. 6. 19. 2	Unlocking the terminal for each call	435
9. 6. 20	Making calls with your own settings on a third-party phone	438
9. 6. 21	Private calls with PIN	439
9. 6. 22	Appointment reminder call	440
9. 6. 23	Acceptance of a call or data connection:	442
9. 6. 23. 1	Preliminaries	442
9. 6. 23. 2	Accepting the connection	443
9. 6. 24	Take (taking a call)	444
9. 6. 25	Fast take (pick up a call or a call connection)	445
9. 6. 26	Room monitoring (Baby surveillance)	447
9. 6. 26. 1	Detailed Description	448
9. 6. 26. 2	Functions	448
9. 6. 26. 3	Active room monitoring	449
9. 6. 26. 4	Passive room monitoring	451
9. 6. 27	Conversation recording	452
9. 7	Special features	455
9. 7. 1	Coded ringing on general bell	455
9. 7. 1. 1	Answer general bell	456
9. 7. 1. 2	General bell on analogue terminal interface FXS	457
9. 7. 2	Announcement service	458
9. 7. 3	Clear configurations	465
9. 7. 4	LCR Function	466
9. 7. 5	Emergency numbers	466
9. 7. 6	Suppression of the call number display	468
9. 7. 7	Recording malicious calls (MCID)	470
9. 7. 8	User group: Logging in and logging out	472
9. 7. 9	Home alone	473
9. 7. 10	Switching switch groups	476
9. 7. 11	Switch control outputs	478
9. 7. 12	Door function	479
9. 7. 12. 1	Door bell	480
9. 7. 12. 2	Open door	481
9. 7. 12. 3	Dial door intercom	483
9. 7. 13	System time and system date	484
9. 7. 14	Free seating	486
9. 8	Remote control features	487
9. 8. 1	Remote controlling features from within the system	490
9. 8. 2	Remote controlling features from outside the system	491
9. 8. 3	Time-controlled functions	493

9.9	Accommodation/Hotel.....	496
9.9.1	Features in mode V2.....	496
9.9.2	Configuration and operating concept.....	497
9.9.3	Network printer and Aastra 400 Print Spooler.....	499
9.9.4	Function codes in prefix dialling.....	499
9.9.5	System configuration.....	502
9.9.6	Features in mode V1.....	505
9.9.6.1	Configuration and operating concept.....	505
9.9.6.2	Setting up rooms/phone booths.....	506
9.9.6.3	Room-to-room traffic.....	506
9.9.6.4	Room status.....	507
9.9.6.5	Wake-up call.....	508
9.9.6.6	Phone booth.....	508
9.9.6.7	Property Management Systems (PMS).....	511
9.10	Message and Alarm Systems.....	511
9.10.1	Internal messaging system for system phones.....	512
9.10.2	Expanded messaging system with 9d-DECT phones.....	512
9.10.3	External messaging and alarm systems.....	513
9.10.3.1	Message handling.....	513
9.10.3.2	Alarm handling.....	515
9.10.3.3	Alarm trigger with ATAS.....	515
9.10.3.4	Alarm trigger with ATAS/ATASpro.....	517
9.10.3.5	Interface descriptions.....	518
10	Features Overview.....	519
	Index.....	538

1 Product and Safety Information

Here you will find information relating to safety, data protection and legal matters besides product and documentation information. Please read through the product and safety information carefully.

1.1 Product information

Purpose and function

Aastra 400 is an open, modular and comprehensive communication solution for the business sector with several communication servers of different performance and expansion capacity, an extensive telephone portfolio and a multitude of expansions. They include an application server for unified communications and multimedia services, an FMC controller for mobile phone integration, an open interface for application developers, and a multitude of expansion cards and modules.

The business communication solution with all its elements was designed to cover the full spectrum of communication requirements of businesses and organizations in a user and maintenance-friendly way. The individual products and parts are coordinated and cannot be used for other purposes or replaced by outside products or parts (except to connect up other authorized networks, applications and phones to the interfaces certified for that purpose).

User groups

The phones, softphones and PC applications of the Aastra 400 communication solution are particularly user friendly in design and can be used by all end users without any specific product training.

The phones and PC applications for professional applications such as PC operator consoles or call centre applications require training of the personnel.

Specialist knowledge of IT and telephony is assumed for the planning, installation, configuration, commissioning and maintenance. Regular attendance at product training courses is strongly recommended.

User information

Aastra 400 products are supplied complete with safety and product information, quick user's guides and user's guides.

These and all other user documents such as system manuals are available for download from the Aastra 400 DocFinder as individual documents or as a documentation set. Some user documents are accessible only via a partner login.

It is your responsibility as a specialist retailer to keep up to date with the scope of functions, the proper use and the operation of the Aastra 400 communication solution and to inform and instruct your customers about all the user-related aspects of the installed system:

- Please make sure you have all the user documents required to install, configure and commission a Aastra 400 communication system and to operate it efficiently and correctly.
- Make sure that the versions of the user documents comply with the software level of the Aastra 400 products used and that you have the latest editions.
- Always read the user documents first before you install, configure and put a Aastra 400 communication solution into operation.
- Ensure that all end users have access to the user's guides.

Downloading documents from the internet

Aastra 400 DocFinder: www.aastra.com/DocFinder

© The information, graphics and layouts featured in the user information are subject to copyright and may not be duplicated, presented or processed without the written consent of Aastra Telecom Schweiz AG.

Conformity

Aastra Telecom Schweiz AG hereby declares that

- the Aastra 400 products conform to the basic requirements and other relevant stipulations of Directive 1999/5/EC.
- all our products are manufactured in conformity with RoHS and WEEE (2002/95/EC and 2002/96/EC).

The product-specific declarations of conformity can be found on the Aastra 400 DocFinder.

Trade names

Aastra® is a registered trademark of Aastra Technologies Limited.

All other trademarks, product names and logos are trademarks or registered trademarks of their respective proprietors.

Usage of third party software

Aastra 400 products comprise, or are partially based on, third-party software products. The licence information for these third-party products is listed in the user's guide of the Aastra 400 product in question.

Exclusion of Liability

All parts and components of the Aastra 400 communication solution are manufactured in accordance with ISO 9001 quality guidelines. The relevant user information has been compiled with the utmost care. The functions of the Aastra 400 products have been tested and approved after comprehensive conformity tests. Nonetheless errors cannot be entirely excluded. The manufacturers shall not be liable for any direct or indirect damage that may be caused by incorrect handling, improper use, or any other faulty behaviour. Potential areas of particular risk are signalled in the appropriate sections of the user information. Liability for loss of profit is excluded in any case.

Environment

Aastra 400 products are delivered in recycled, chlorine-free corrugated cardboard packaging. The parts are also wrapped inside a protective fleece made of polyethylene foam fleece or polyethylene film for added protection during shipping. The packaging is to be disposed of in accordance with the guidelines stipulated under current legislation.



Aastra 400 products contain plastics based on a pure ABS, sheet steel with an aluminium-zinc or zinc finish, and epoxy resin-based PCBs. These materials are to be disposed of in accordance with the guidelines stipulated under current legislation.

Aastra 400 products are disassembled exclusively using detachable screwed connections.

1.2 Safety information

Reference to hazards

Hazard warnings are affixed whenever there is a risk that improper handling may put people at risk or cause damage to the Aastra 400 product. Please take note of these warnings and follow them at all times. Please also take note in particular of hazard warnings contained in the user information.

Operating safety

Aastra 400 communication servers are operated on 230 VAC mains power. Communication servers and all their components (e.g. telephones) will not operate when mains power fails. Interruptions in the power supply will cause the entire system to restart. A UPS system has to be connected up-circuit to ensure an uninterruptible power supply. Up to a specific performance limit a Aastra 470 communication

server can also be operated redundantly using an auxiliary power supply. For more information please refer to your communication server's system manual.

When the communication server is started for the first time, all the configuration data is reset. You are advised to backup your configuration data on a regular basis as well as before and after any changes.

Installation and operating instructions

Before you begin with the installation of the Aastra 400 communication server:

- Check that the delivery is complete and undamaged. Notify your supplier immediately of any defects; do not install or put into operation any components that may be defective.
- Check that you have all the relevant user documents at your disposal.
- During the installation follow the installation instructions for your Aastra 400 product and observe to the letter the safety warnings they contain.

Any servicing, expansion or repair work is to be carried out only by technical personnel with the appropriate qualifications.

1.3 Data Protection

Protection of user data

During operation the communication system records and stores user data (e.g. call data, contacts, voice messages, etc.). Protect this data from unauthorised access by using restrictive access control:

- For remote management use SRM (Secure IP Remote Management) or set up the IP network in such a way that from the outside only authorised persons have access to the IP addresses of the Aastra 400 products.
- Restrict the number of user accounts to the minimum necessary and assign to the user accounts only those authorisation profiles that are actually required.
- Instruct system assistants to open the remote maintenance access to the communication server only for the amount of time needed for access.
- Instruct users with access rights to change their passwords on a regular basis and keep them under lock and key.

Protection against listening in and recording

The Aastra 400 communication solution comprises features which allow calls to be monitored and recorded without the call parties noticing. Inform your customers that these features can only be used in compliance with national data protection provisions.

Unencrypted phone calls made in the IP network can be recorded and played back by anyone with the right resources:

- Use encrypted voice transmission (Secure VoIP) whenever possible.
- For WAN links used for transmitting calls from IP or SIP phones, use as a matter of preference either the customer's own dedicated leased lines or with VPN encrypted connection paths.

1.4 About this System Manual

This document describes the system functions and features of communication servers of the Aastra 400 series. The expansion stages, system capacity, installation, configuration, the operation and maintenance, the technical data, the DECT planning, and the possibilities for networking several systems into a private network (PISN) or an Aastra Intelligent Net (AIN) are not part of this Manual. They are described in separate documents.

The System Manual is available only in electronic form as a document in Acrobat Reader format, and can be printed out. Navigation in PDF format is based on the bookmarks, table of contents, cross references and index. All these navigation aids are linked, i.e. a mouse click takes you directly to the corresponding places in the Manual. We have also ensured that the page numbering in the PDF navigation corresponds to the page numbering of the Manual, making it much easier to jump to a particular page.

Referenced menu entries and parameters appearing on terminal displays or in AIMS AMS (Aastra Management Suite) are *highlighted* in italics and in colour for a clearer orientation.

Document information

- Document number: syd-0367
- Document version: 1.1
- Valid as of: R2.0
- © 02.2012 Aastra Technologies Limited
- In PDF viewer, click on this link to download the latest version of this document:
https://pbxweb.aastra.com/doc_finder/DocFinder/syd-0367_en.pdf?get&DNR=syd-0367

General Considerations

Special symbols for additional information and document references.



Note

Failure to observe information identified in this way can lead to equipment faults or malfunctions or affect the performance of the system.



Tip

Additional information on the handling or alternative operation of equipment.



See also

Reference to other chapters within the document or to other documents.



Aastra Intelligent Net

Particularities that have to be observed in an AIN.

Safety Considerations

Special hazard alert messages with pictograms are used to signal areas of particular risk to people or equipment.



Hazard

Failure to observe information identified in this way can put people and hardware at risk through electrical shock or short-circuits respectively.



Warning

Failure to observe information identified in this way can cause a defect to a module.



Warning

Failure to observe information identified in this way can lead to damage caused by electrostatic discharge.

1.5 About Aastra

Aastra Technologies Limited is one of the world's leading manufacturers of communication systems. When developing products and solutions the prime objective is always to optimise the communication processes of small, medium and large companies and cut costs as a result.

Aspects of modern office communications such as mobility, future viability, security and availability are as much an integral part of the development work as user friendliness and product design. The offer covers the entire range of VoIP and SIP solutions, including communication servers, gateways, system phones and process-oriented software solutions.

With its pioneering innovations Aastra consistently promotes the convergence of voice and data communications in its solutions. Aastra's clientele includes acknowledged telephone and data network operators in North America, Europe and Africa as well as Internet Service Providers and distributors of renown.

Aastra Technologies Limited, (TSX: "AAH"), is a leading company at the forefront of the enterprise communication market. Headquartered in Concord, Ontario, Canada, Aastra develops and delivers innovative communication products and applications for businesses. Aastra's operations are truly global with more than 50 million installed lines around the world and a direct and indirect presence in more than 100 countries. The large portfolio offers multi-functional Call Managers for small and medium-sized companies as well as highly scalable Call Managers for big companies. Integrated mobility solutions, call centre solutions and a broad range of telephones round off the portfolio. With a strong focus on open standards, Aastra enables enterprises to communicate and collaborate more efficiently. For additional information on Aastra, visit our website.

2 System interfaces

This chapter features the different types of digital and analogue network and terminal interfaces and points out a number of configuration particularities. The chapter ends with special interfaces for door intercoms and general bells.

Tab. 1 System interfaces and channels

Term	Explanation
B channel	User information channel: Each connection occupies one user information channel, e.g. 2 user information channels (connections) can be occupied simultaneously using one basic access.
D channel	Control and signalling channel: Channel for control and signalling as well as for packet data transfer.
2B+D / 30B+D	2 2 B channels and 1 D channel / 30 B channels and 1 D channel
Ports	Physical connection points on the communication server for network interfaces and terminal interfaces
Network interfaces <ul style="list-style-type: none"> • Basic rate interface BRI-T • Basic access S external • Primary rate interface PRI • SIP access via the Ethernet interface on the basic system • Analogue network interface (FXO network interface) 	Network-side connection possibilities for the communication server <p>Digital network interface 2B+D</p> <p>Digital network interface 2B+D: A terminal interface S configured as <i>EXTERN</i>.</p> <p>Digital network interface 30B+D</p> <p>For connection to one or more SIP providers. An SIP access contains a maximum of 30 channels.</p> <p>An analogue network connection has 1 user information channel.</p>
Terminal interfaces <ul style="list-style-type: none"> • ISDN terminal interface (Terminal interface BRI-S) • Digital user-network interfaces (DSI terminal interface) • IP terminal interface (via Ethernet Interface) • Analogue terminal interfaces (FXS terminal interface) 	Terminal-side connection possibilities for the communication server <p>Digital terminal interface 2B+D: Connection for Euro ISDN terminals, Terminal Adapters and ISDN PC cards.</p> <p>A maximum of 2 digital system phones or one system phone and one DECT radio unit can be operated on a proprietary DSI bus.</p> <p>Digital terminal interface for linking up IP system phones and SIP phones (softphones and desk phones).</p> <p>An analogue terminal connection has 1 user information channel.</p>
Special interfaces <ul style="list-style-type: none"> • Ethernet interface on the basic system • Door Intercom Systems • General Bell 	Other connection possibilities for the communication server <p>Central interface for connecting AMS, a CTI server, IP system phones, SIP terminals, for the network-side connection to an SIP service provider, or to implement an Aastra Intelligent Net.</p> <p>Special interface for connecting door intercom systems</p> <p>Special interface for general bell</p>

2.1 Network Interfaces

The system supports the following types of network interfaces:

- Basic rate interface BRI-T for connection to
 - the public ISDN network
 - the private leased-line network
- Basic access S external for connection to
 - the private leased-line network
 - a terminal with its own direct dialling plan (DDO)
- Primary rate access PRI for connection to
 - the public ISDN network
 - the private leased-line network
- SIP access via the Ethernet interface on the basic system for connection to SIP provider.
- Analogue network interface for connection to the public analogue network

2.1.1 Basic Access Variants

A basic access is a digital network interface for connection to the public network or to the private leased-line network. It can be set for the protocols DSS1 (public ISDN network) and QSIG / PSS1 (private leased-line network).

A basic access has two 64 kbit/s user information channels and one 16 kbit/s control and signalling channel (2B+D).

One call or data connection can be set up on each bearer channel (B channel) simultaneously and independently of the other B channel.

A basic access can be barred for outgoing calls (*Outgoing Calls Barred* setting).

Basic accesses for connecting the communication server to the public network can be operated as point-to-point and, with some network providers, also as point-to-multipoint (multiple subscriber number) access.

There are two types of basic access:

- Basic rate interface BRI-T
- Basic access S external

2. 1. 1. 1 Basic rate interface BRI-T

Basic access T is suitable for connection to both the public ISDN network and the private-leased-line network.

2. 1. 1. 2 BRI-S basic rate interface external

The basic access S external is an BRI-S interface configured as external (*S-bus protocol* = *EXTERNALS* setting in the interface configuration).

The basic access S external is designed for the following purposes:

- For connection to the private leased-line network or
- For connecting DSS1 terminal equipment, which evaluates the DDI number sent by the communication server and routes the call accordingly (e. g. a fax server, see also "Direct Dialling Out (DDO)", page 28)

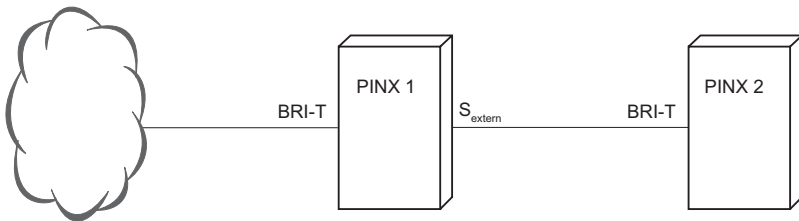

Fig. 1 S external in a private leased-line network: PINX-PINX connection

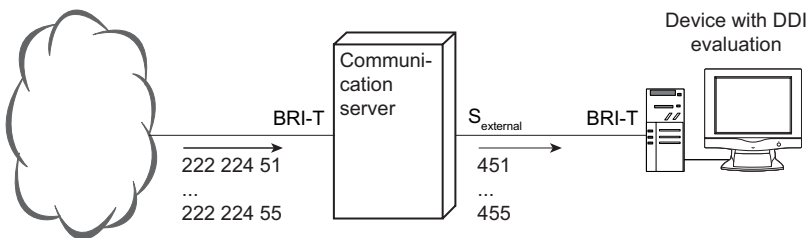

Fig. 2 S external in a DDI configuration



Note:

An BRI-S interface configured as external is a fully-fledged network interface and is no longer available as a user-network interface. A basic access S external cannot be used as a connection to the public ISDN network.

2. 1. 1. 3 Point-to-Point and Point-to-Multipoint Connections

Basic accesses can be configured as point-to-point or as point-to-multipoint (*TEI Management* setting in the configuration of the network interfaces).

Point-to-Multipoint Connection without a communication server

The basic access in point-to-multipoint configuration allows a selective dial-up of the terminals connected in parallel using MSN, the Multiple Subscriber Number. Here the network itself provides a kind of direct dialling, so to speak.

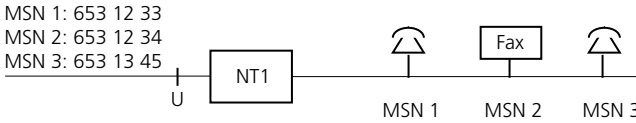

NT1: Network Termination

MSN: Multiple Subscriber Number

Fig. 3 Single basic access in point-to-multipoint configuration



Note:

The fax with ISDN connection is implemented as a fax card in a PC.

Default setting:

Digital network interfaces are set on point-to-point configuration.

Point-to-Multipoint Connection with communication server

If a communication server is connected using point-to-multipoint, a direct dial number must be created for each MSN number, with all the digits of the MSN number.

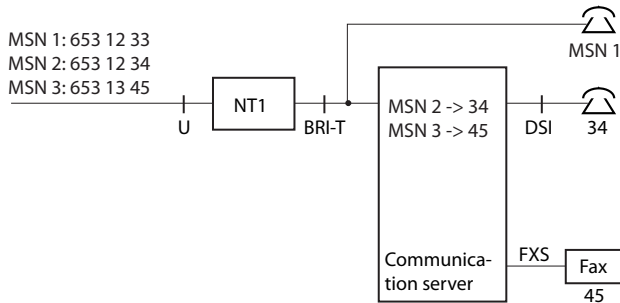

- NT1: Network Terminal
- MSN: Multiple Subscriber Number
- U/T: ISDN reference point
- DSI: Digital terminal interface DSI
- FXS: Analogue terminal interface FXS

Fig. 4 Basic access in point-to-multipoint configuration, with single-digit direct dial and parallel terminal

Combinations are also possible in the case of several lines, e.g. one line in point-to-multipoint configuration and the remaining in point-to-point configuration.



Note:

If terminals (e. g. MSN1) are connected in parallel on the BRI-T interface, “Collision detection” has to be activated as the communication server and the terminal influence each another. This also applies in cases where analogue connections are used on NT1.

Point-to-Point Connection without Direct Dial

Without direct dialling in, only one call number is available. The individual internal users can only be reached indirectly via the number.

This variant is suitable above all for systems with primarily outgoing traffic.

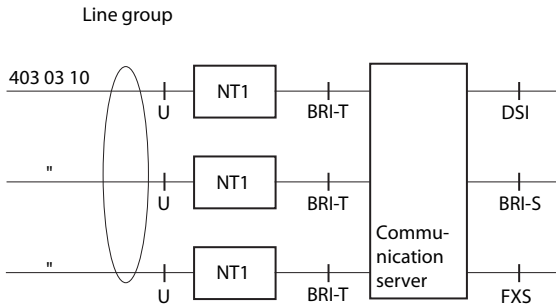

- NT1: Network Terminal
- U/T: ISDN reference point
- DSI: Digital terminal interface DSI
- BRI-S: ISDN terminal interface
- FXS: Analogue terminal interface FXS

Fig. 5 Several basic accesses with line group in point-to-point configuration, without direct dial number



Note:

Do not connect any terminals between the NT1 and the communication server.

Point-to-Point Connection with Direct Dial

With direct dial the individual communication server users can be reached directly via their direct dial number.

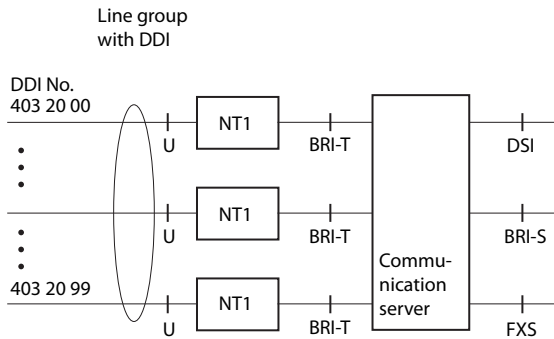

NT1: Network Terminal
 DDI: Direct dialling
 U/T: ISDN reference point
 DSI: Digital terminal interface DSI
 BRI-S: ISDN terminal interface
 FXS: Analogue terminal interface

Fig. 6 Several basic accesses in point-to-point configuration, with direct dial number



Note:

Do not connect any terminals between the NT1 and the communication server.

Periodic Reactivation of Layer 2 on the BRI-T-Interface¹⁾

Layer 2 of the BRI-T network interface can be reactivated periodically every three minutes so that incoming calls are not rejected already at the local exchange after potential temporary interruptions in the U-interface. To do so, configure the parameter *L2 activation* of the BRI-T network interface to *special*.



Note:

In some countries BRI-T network interfaces are deactivated once a certain amount of time has elapsed without traffic, and are only reactivated when the communication server once again requests a connection.

¹⁾ Only in Germany and Austria.

2. 1. 2 Primary rate interface PRI

A primary rate access is a digital network interface for connection to the public network or the private leased-line network. It can be set for the protocols DSS1 (public ISDN network) and QSIG / PSS1 (private leased-line network).

A primary rate access has thirty 64 kbit/s user information channels and one 64 kbit/s control and signalling channel (30B+D). One call or data connection can be set up on each bearer channel (B channel) simultaneously and independently of the other B channel.



Note:

Primary rate accesses can only be used as point-to-point connections.

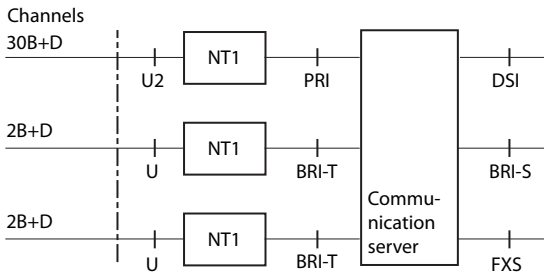

- NT1: Network Terminal
- U2/U/T2/T: ISDN reference points
- 30B+D: Primary rate access channels
- 2B+D: Basic access channels
- DSI: Digital terminal interface
- BRI-S: ISDN terminal interface
- FXS: Analogue terminal interface

Fig. 7 System with basic and primary rate accesses

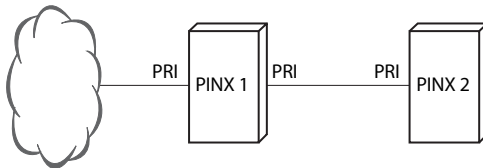

Fig. 8 Primary rate access in a private leased-line network: PINX-PINX connection

2.1.2.1 Clock synchronization

The clock frequency of a communication server is provided (synchronized) by the public network via the basic accesses BRI-T and the primary rate accesses PRI.

Should synchronization by the public network fail (due, for example, to exchange line interruptions), the communication server will use its own clock. This frequency deviates at most by 5 ppm from the nominal value, which ensures that the Aastra DECT system also remains available.

In a private leased-line network, PINXs that are synchronized by the public network pass on the clock reference to PINXs that are not connected directly to the public network.

Synchronization in the private fixed network has to be carefully planned to ensure there are no synchronization loops (see "PISN/QSIG networking" System Manual, "Synchronization" Chapter).

All the private leased-line network connections and public exchange line circuits are automatically in a shared clock reference table when the communication server is configured for the first time.

If a communication server is not networked in a PISN, the clock reference table can be left as it is; only the initial reference may have to be assigned differently.

2.1.2.2 Digital down-circuit connection with QSIG

If a down-circuit communication server is connected with an up-circuit communication server via digital lines (BRI-T, PRI), all the features as per QSIG are available providing the up-circuit communication server supports the QSIG protocol.

The down-circuit communication server is configured in accordance with the rules for networked systems.

The up-circuit communication server has a connection to the public network. It can also be an Aastra 400 system or a third-party product, provided it supports the QSIG protocol.

As a rule the down-circuit communication server is connected with the up-circuit communication server via its own fixed lines. The interfaces can be basic rate interfaces (BRI-T) or primary rate interfaces (PRI). Connections on an S external-type interface are also possible instead of connections on a BRI-T interface, providing at least one BRI-T interface is available for synchronization via the ISDN network.

Example: Down-circuit connection with cordless system

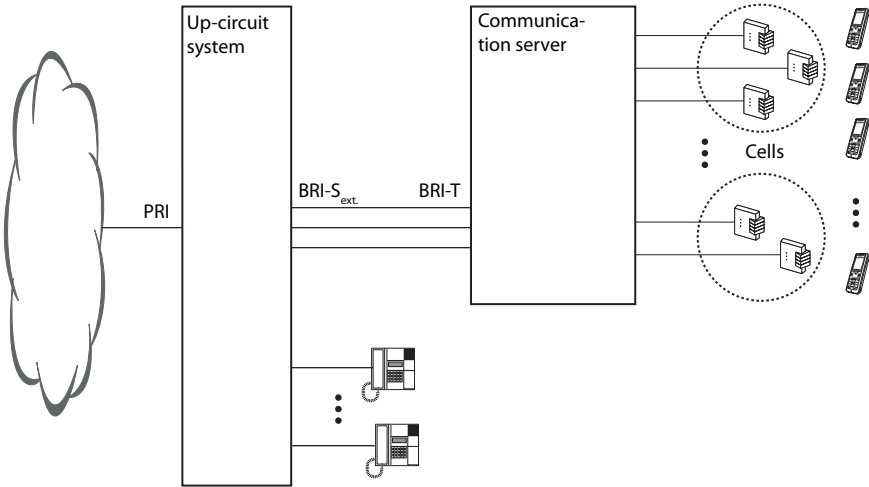

Fig. 9 Digital down-circuit connection with QSIG

2. 1. 2. 3 Direct Dialling Out (DDO)

If a fax server is connected to an S bus, individual fax receivers allocated a DDI number can be specifically addressed. In terms of routing technology, this corresponding to a DDO (Direct Dialling Out) function.

The fax server forwards the incoming faxes via e-mail to the relevant PC stations that are set up as fax receivers.

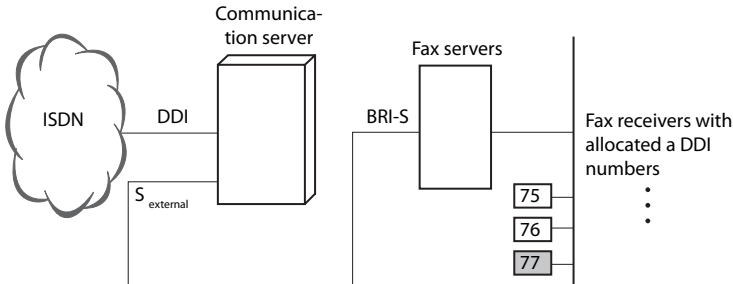

Fig. 10 Direct Dialling Out (DDO) to a fax server

Due to the configuration of the BRI-S interface as *EXTERNALS* and the use of the DSS1 protocol, the fax calls can be routed via routes and trunk groups. This means

that all fax receivers that have been allocated a DDI number can be reached via a single BRI-S interface.



See also:

"Call to DSS1 Terminal Equipment on the S Bus (DDO)" Chapter in the "System Functions and Features" System Manual

2.1.3 SIP access

The communication server can be connected to one or more SIP providers via the Ethernet interface on the basic system. The communication server supports 10 SIP access with up to 30 channels per SIP access. One *SIP Access Channels* licence is required for each channel.

The communication server handles the SIP access in the same way as analogue or digital network interfaces, i. e. they are grouped in one or more separate trunk groups. The allocation to an SIP provider is defined for each trunk group. This means for example that international calls can be routed via SIP providers in different countries.

The communication server must register with a registrar of the SIP provider so that the SIP messages can be forwarded to the proxy server and from there to the public network, for example via a gateway. At least one SIP account has to be set up for each SIP provider. Each account contains a user name and password for identification with the Registrar and an SIP identification number (SIP-ID). The SIP-ID is linked with a direct dial number so that outgoing and incoming connections can be made. A total of 500 SIP accounts can be set up and linked with the corresponding direct dialling numbers.

One SIP account per SIP provider can be set up as a default account. It can then be used by users without an SIP account for outgoing calls via a corresponding route or for incoming calls via a special call routing.

Besides the connection of communication servers to one or more SIP providers, several communication servers can also be networked via SIP.

System configuration

The tables below list the AMS configuration parameters required.

Tab. 2 SIP provider configuration: General

Parameter	Parameter value	Remarks
Name	<Name>	Name of the SIP provider
Broadband range	<Name>	Predefined broadband range used for this SIP provider.
Use '+' for the international prefix	<Yes / No>	If the provider requires the number in canonical number format, the parameter must be set to <i>Yes</i> .
Try to make external calls: Timeout	<4...36> sec.	Indicates how long the system attempts to dial via an SIP exchange before it switches to the next trunk group in the route. (Default: 32 s)
'From' field for CLIR	<Anonymous (RFC 3261) / Transfer from SIP account (RFC 3323) / Name displayed is 'Anonymous'>	Display shown to the recipient in the case of an outgoing call with activated CLIR
Use DNS_SRV (RFC 3263)	<Yes / No>	Mechanism for SIP server (or SIP service) resolution e. g. through a URI/URL with the aid of a DNS query.
Send 'Session Refresh' (RFC 4028)	<Yes / No>	If this parameter is on <i>Yes</i> , the communication server will attempt to negotiate a period for regular "Session Refresh Messages" with the SIP provider. For this the SIP provider must also support RFC4028.

Tab. 3 SIP provider configuration: Registrar

Parameter	Parameter value	Remarks
IP address	<Address>	IP address of the Registrar at the SIP provider The communication server has to set up a connection to the address in order to register.
Port	<1...65535>	UDP port of the Registrar at the SIP provider
Name	<Name>	Domain name of the registrar at the SIP provider
Preferred registration interval	<60...65535> sec.	Once this period of time has elapsed, the communication server automatically registers with the SIP registrar on a regular basis in order to maintain a faultless connection.

Tab. 4 SIP provider configuration: Proxy

Parameter	Parameter value	Remarks
IP address	<Address>	IP address of the proxy server at the SIP provider All the communication server's external SIP messages are sent to this address (<i>Primary proxy</i>). If it is not available, the messages are sent to the alternative IP address (<i>Secondary proxy</i>)
Port	<1...65535>	UDP port of the SIP proxy server
Name	<Name>	Domain name of the SIP proxy server, e. g. URL

Tab. 5 SIP provider configuration: NAT

Parameter	Parameter value	Remarks
<i>Activate 'Keep alive'</i>	<Yes / No>	If the parameter is on <i>Yes</i> the system periodically updates the NAT table on its own firewall using "Notify" messages to the proxy server. This means that the system remains reachable for incoming SIP calls.
<i>ALG support</i>	<Yes / No>	Supports the connection to SIP providers (depends on the provider). If the parameter is configured as <i>Yes</i> , IP packets that contain SIP signalling information are opened by the ALG (Application Layer Gateway) and the private IP address is replaced by the public IP address. (The public IP address in the system must be configured.)

Tab. 6 SIP provider configuration: SIP access

Parameter	Parameter value	Remarks
<i>Trunk groups</i>	<Name>	Here the SIP provider is assigned to a new trunk group.
<i>Maximum incoming calls</i>	<30...240>	No further calls are routed via this trunk group once the set limit is reached. This is signalled to the caller by means of the congestion tone.
<i>SIP access without accounts</i>	<Yes / No>	This parameter has to be set to <i>Yes</i> to enable the SIP networking of systems. The parameter can only be configured if no accounts are assigned to the SIP provider.

Tab. 7 SIP account configuration

Parameter	Parameter value	Remarks
<i>Name</i>	<Name>	Name of the SIP account
<i>Display Name (name to be displayed)</i>	<String>	Some providers require this entry. A name or a number such as the SIP ID is entered here.
<i>SIP ID</i>	<Number>	Identifier of this account with the SIP provider. This is the access number of the account which is then linked with a direct dialling number in the communication server. This parameter must be specified at all times.
<i>User name</i>	<Name>	User name of the SIP account with the SIP provider. This parameter is to be specified only if the SIP provider requires authentication.
<i>Password</i>	<Password>	Password of the SIP account with the SIP provider. This parameter is to be specified only if the SIP provider requires authentication.
<i>Registration required</i>	<Yes / No>	If this parameter is set on <i>Yes</i> , the SIP account will attempt to register with the provider. The SIP provider is then informed about the SIP user's current location.
<i>Registered</i>	<Yes / No>	Status field
<i>Default account</i>	<Yes / No>	The default account allows users without SIP account to make calls via the SIP trunk.

Parameter	Parameter value	Remarks
<i>DDI number</i>	<DDI No.>	The DDI number with which the SIP-ID is to be linked is entered in this field. The field can be left blank if the SIP-ID corresponds to the DDI number.
<i>'From' field: Type</i>	<SIP ID / Direct dialling number / System CLIP / User defined>	Specifies what is entered in the definable part of the 'From' field for outgoing calls.
<i>'From' field: String</i>	<String>	User-definable character string in the 'From' field for outgoing calls.



See also

More detailed information on SIP access can be found in the "SIP Access" User's Guide (syd-0176, currently available in English only).

2.1.4 Analogue Network Interfaces

The analogue network interfaces support DTMF and pulse dialling. A range of parameters in the System Configurations allows country-specific adaptations to the public network as well as other settings. The table below shows the configuration options available:

System configuration

Tab. 8 Analogue network interfaces: System configuration

Parameter	Parameter value	Remarks
<i>Behind communication server</i>	[Yes / No]	See "Analogue down-circuit connection", page 34
<i>Line Attenuation</i>	[short / long / short D / long D]	See "Attenuation on analogue network interfaces", page 36
<i>Dialling mode</i>	[PULSE / DTMF]	DTMF dialling should be used in preference whenever both dialling types are supported.
<i>Ringing cycle</i>	[5...60 seconds]	With incoming calls the internal ringing signal is discontinued if the time between each ringing signal on the exchange line is longer than the configured ringing cycle. This is the case for example when the external caller hangs up.
<i>Dialling tone detection</i>	[Yes / No]	If <i>Yes</i> , the communication server waits for the dial tone from the exchange before starting to dial.
<i>Dialling tone time</i>	[0...1200 seconds]	Maximum waiting time for the exchange dial tone if exchange dial tone detection is activated. After that, the PBX switches over to the next free trunk line. If dial tone detection is deactivated, dialling begins after the set time, even without an exchange dial tone.
<i>International dialling tone</i>	[Yes / No]	If <i>Yes</i> , the dialling process is interrupted after one of 10 predefined digit sequences to wait for the international dialling tone.

Parameter	Parameter value	Remarks
<i>Exchange digit barring</i>	[No international dialing tone or 1...10]	If the trunk line is configured to <i>Behind communication server</i> (analogue down-circuit connection), the exchange access prefix of the up-circuit communication server has to be entered in the exchange digit barring.
<i>Release signal</i>	[Yes / No]	In most cases the public network sends the communication server a release signal whenever the external user ends the call. If the parameter is configured to <i>Yes</i> , the connection is subsequently cleared down by the communication server (see " Clearing down Exchange-to-Exchange Connections ", page 225").
<i>Release signal type</i>	[Loop-break / Polarity reversal / Congestion tone]	There are different types of release signals. The correct configuration depends on the carrier (see " Clearing down Exchange-to-Exchange Connections ", page 225).
<i>Congestion tone level</i>	[High / Low]	The sound level of the congestion tone can vary greatly within a country and depending on the line length. With this setting the detection can be adapted to the existing level.
<i>CLIP detection</i>	[Yes / No]	See " CLIP on analogue exchange accesses ", page 101
<i>Alerting signal type</i>	[No alerting signal / Ring pulse / Dual Tone / Line reversal & Dual Tone / Not defined]	There are different methods for transmitting CLIP data on analogue exchange accesses. An alerting signal is needed to detect CLIPs. The value of the parameter depends on the network provider. <i>No alerting signal:</i> Data transmission takes place between the first and second ring signal. The first ring signal is used as an alerting signal. <i>Ring pulse:</i> Data transmission takes place before the first ring signal. A ring pulse is used as an alerting signal. <i>Dual Tone:</i> Data transmission takes place before the first ring signal. Two successive tones (Dual Tone) are used as the alerting signal. <i>Line Reversal & Dual Tone:</i> Data transmission takes place before the first ring signal. A line polarity reversal is used as the alerting signal, followed by two successive tones (Dual Tone). <i>Not defined:</i> No data is detected.
<i>CLIP data damping</i>	[Yes / No]	The level of CLIP data varies from one network provider to the next. An excessively high level can lead to detection problems. Activating this parameter can attenuate the signal.

2. 1. 4. 1 Analogue down-circuit connection

With an analogue down-circuit connection the features of the up-circuit communication server can also be utilized.

This results in the following special applications for the user:

- Depending on the system configuration the user makes phone calls in a complex environment. The subscriber's disposal is a large number of features at two levels (subscriber's own system and the up-circuit system). A short induction course helps users to familiarize themselves quickly with the new environment.
- Practically all the systems used as up-circuit systems also feature the DTMF dialling method on the analogue terminal line, in addition to pulse dialling. It is advisable to give preference to the DTMF dialling method over pulse dialling.
- If the up-circuit communication server requires that subscribers wait for the exchange-free tone, all the entered abbreviated dialling numbers must be provided with a hyphen "-" (interdigit pause) after the digits for exchange access. At this point the communication server will again pause for the tone when dialling.

Example: Exchange access via exchange access prefix

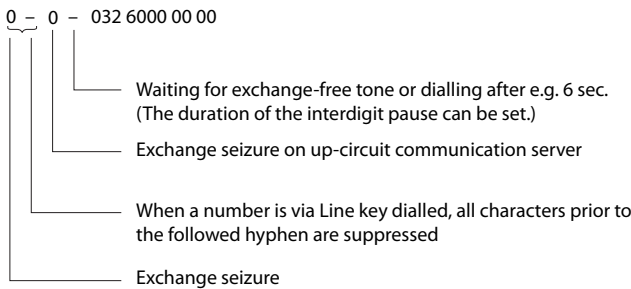

Fig. 11 Example of the exchange access prefix via up-circuit communication server

The following configuration steps are necessary:

1. The exchange access prefix of the up-circuit communication server must be entered in the exchange digit barring.
2. The corresponding analogue trunk lines are configured to *Behind communication server*. Consequence:
 - Digit barring is switched off in general. The digit barring of the up-circuit communication server has to be used.

- Incoming calls are forwarded transparently to the user.
3. The corresponding analogue trunk lines are to be configured to the correct *Dial sort*. If the up-circuit communication server provides DTMF and pulse dialling for internal users, it is advisable to configure DTMF.

Example: Enquiry call behind communication server

This feature can be used from both analogue terminals and system phones.

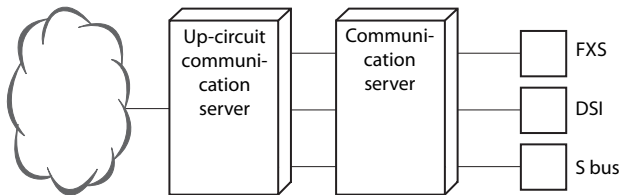

Fig. 12 Enquiry call behind communication server

Situation: The existing call connection of an Aastra 400 user already seizes a trunk line to the up-circuit communication server. The procedure for setting up an inquiry call depends on the type of terminal:

- Analogue terminal
 - Flash: Dialling tone of the Aastra 400 communication server
 - Flash *42: Dialling tone of an up-circuit communication server
- System phones
 - Enquiry call menu: Dialling tone of the Aastra 400 communication server
 - Key with macro "I*42": Dialling tone of an up-circuit communication server

Using the exchange's features

To activate features on the public network such as the exchange feature "Call Forwarding" from the system itself, you need to seize a trunk line. The feature can then be entered in accordance with the service provider's operating instructions.



See also:

System configuration:

- *Behind communication server*; Analogue network interfaces
- *Dialling type*; Analogue network interfaces

2.1.4.2 Attenuation on analogue network interfaces

With analogue network connections you have a choice of four different attenuation settings:

- *Long* or.
- *Long D* for long lines
- *Short* or
- *Short D* for short lines

On lines with a loop resistance $< 280 \Omega$, *Short* or *Short D* should be selected to avoid problems with echo or instability (feedback).

The "... *D*" settings are used to increase the volume in an "analogue exchange - digital terminal" connection type by 3 dB in both directions as this type of connection is generally perceived as too quiet. The reference level is modified accordingly on the expansion card. Due to the restriction to the aforementioned call type the "... *D*" setting does not result in an increase if an analogue terminal interface is involved in a connection.



Note:

"... *D*" setting should not be used (or only once the stability conditions have been thoroughly clarified) if the equipment (Terminal Adapter) operated on digital interfaces also features a four-wire to two-wire conversion, i. e. an analogue two-wire interface.

Default setting

Analogue network interfaces are set on *Long D*.

2.2 Terminal interfaces

The communication server supports digital and analogue user-network interfaces.

2.2.1 Digital user-network interfaces

On each of these digital user-network interfaces several appropriate terminals can be hooked up and operated simultaneously.

2.2.1.1 Terminal interface BRI-S

The S user-network interface is a digital 4-wire interface used for connecting ISDN terminals, Terminal Adapters and ISDN PC cards. Each of these interfaces has two 64 kbit/s user information channels and one 16 kbit/s control and signalling channel (2B+D). This makes it possible to establish two independent call or data connections simultaneously.

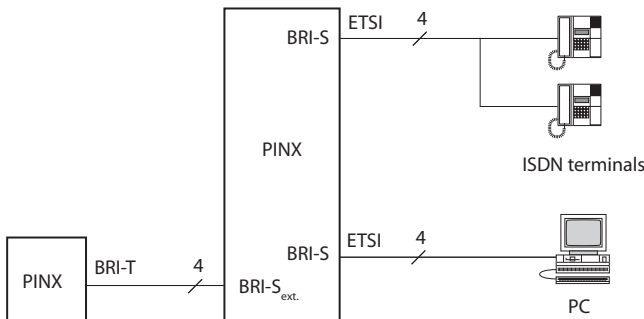

Fig. 13 Terminal interface BRI-S

Up to 8 terminals can be operated on an S user-network interface. They are addressed with the single-digit terminal selection digit (TSD).

Different modes are available for operating the BRI-S interface (*S bus protocol* setting in the interface configuration):

- The *ETSI* mode is used to operate ISDN terminals, Terminal Adapters and ISDN PC cards.
- With the *EXTERNAL* mode an BRI-S interface can be used as a basic access for private networking with QSIG / PSS1 or DSS1. It is then no longer available as a user-network interface (see "[BRI-S basic rate interface external](#)", page 21).

Format of the ETSI S-bus

The format on the ETSI S-bus can be configured in the interface configuration for each BRI-S interface.

Tab. 9 System configuration: Format of the ETSI S-bus

Parameter	Parameter value	Remarks
<i>MSN format on the S-bus</i>	<ul style="list-style-type: none"> • <i>Terminal selection digit (TSD)</i> • <i>User number</i> • <i>DDI number</i> 	<ul style="list-style-type: none"> • A single digit number is used to address the terminals. • Default setting • Mode of operation as customary in the public ISDN network • For special applications (e.g. Unified Messaging Systems). • If the DDI number is missing, the system attempts to transmit one of the following numbers, in the sequence shown below: Number of the CDE, UG number, user number. • Also functions internally.

Exchange Access Prefix for Terminals on the ETSI S Bus

For terminals on the ETSI S-bus the interface configuration can be used to select whether or not the exchange access prefix of the CLIP should be truncated for incoming calls (setting *Remove exchange access prefix*, default setting = *No*). This setting is effective only in the S-bus mode (*S bus protocol = ETSI*).



Aastra Intelligent Net:

In an AIN the call charge format of ISDN terminals depends on the country and is based on the country configured with the AIN region of the node concerned or user. User allocation takes priority over a node-specific allocation.

Voice and data terminals on the BRI-S interface

Both voice and data terminals can be connected to the same BRI-S interface. When designing the system, bear in mind that data terminals can also take up user information channels. ISDN routers and ISDN PC cards that support channel bundling can take up both user information channels.

In mixed operation the availability of the terminals has to be taken into account.

One call or data connection can be set up on each bearer channel (B channel) simultaneously and independently of the other B channel.

2.2.1.2 DSI terminal interfaces

The DSI digital terminal interface is a proprietary, system-specific 2-wire interface used for connecting following terminals:

- DSI system phones
- Aastra DECT Radio units

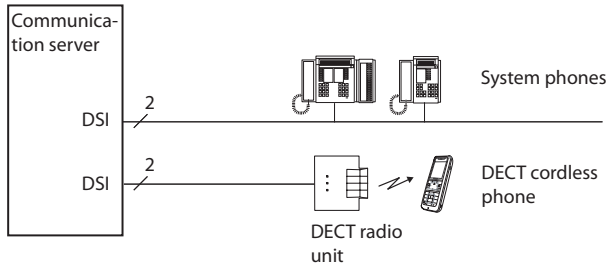

Fig. 14 DSI terminal interfaces

Two system phones can be connected in parallel to a terminal interface DSI. Address allocation is done by means of a switch on the phone.

One DECT radio unit can be connected for each DSI interface. An SB-8 radio unit with 8 call channels occupies two DSI interfaces.

2. 2. 1. 3 IP terminal interface

The IP terminal interfaces are implemented via an Ethernet interface on the communication server. Besides IP system phones Aastra 400 also supports Aastra SIP terminals and standard SIP terminals by other manufacturers.

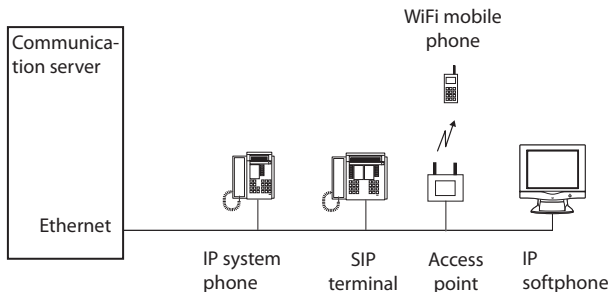

Fig. 15 IP terminal interface

Like the digital system phones the IP system phones (softphones and desk phones) communicate with the communication server via the AD2 protocol. Unlike digital system phones, however, call and signalling data is transmitted in the IP network. The devices are connected to the IP network.

The media data from SIP terminals is processed into packets using the SIP protocol and transmitted using the RTP protocol. Corded SIP desk phones, SIP softphones as well as WiFi mobile phones connected with the IP network via an access point can be operated on an Aastra 400.

The number of terminals on the IP user-network interface (Ethernet) is determined by the system limits on the one hand and by the number of licences on the other.

2.2.2 Analogue terminal interfaces

This 2-wire interface supports the following off-the-shelf analogue terminals:

- Analogue phones with DTMF or pulse dialling (earth key is not supported)
- Analogue radio units for cordless phones
- Two-wire door intercoms with DTMF control functions
- Group 3 fax machines¹⁾
- Answering machines
- Modem

No call charges are transmitted to the connected terminals via analogue terminal interfaces.

CLIP display is possible (see Technical Data in the Aastra 415/430 System Manual or the Aastra 470 System Manual).

One analogue terminal interface per communication server can be configured for connecting a general bell.

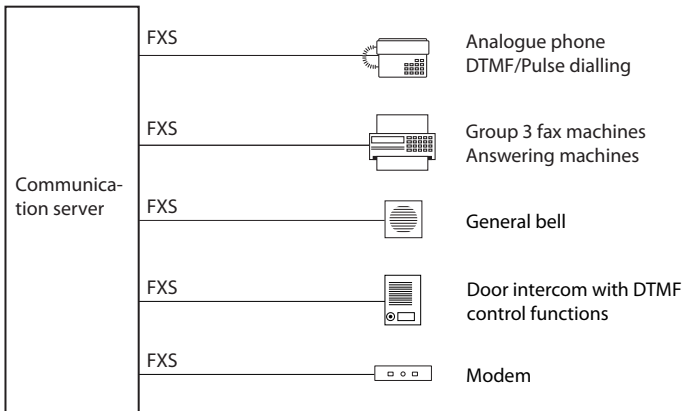

Fig. 16 FXS terminal interface

¹⁾ Transmission with the T.38 protocol is recommended for Fax over IP.

2.3 Special Interfaces

The system supports a range of special interfaces.

2.3.1 Ethernet interfaces

The Ethernet interface on the basic system is available for the following purposes:

- data exchange with AMS
- signalling and transmitting voice data (VoIP) in an Aastra Intelligent Net (AIN)
- linking up the Open Interfaces Platform (OIP)
- the connection of a CTI, alarm, ATAS or messaging server, etc.
- the connection of IP system phones
- the connection of SIP terminals (softphones or desk phones)
- The connection to one or more SIP providers.
- Networking Aastra 400 communication servers via SIP.

2.3.2 Interface for door intercom system

There are different ways of connecting door intercom systems:

- Using an options card ODAB (only Aastra 415/430)
- Using an ordinary analogue terminal port

In a connection using an options card, the equipment or installation is controlled via relays and a control input on the options card.

In a connection using an analogue terminal port the TFE must be capable of sending and receiving DTMF signals as the control is effected acoustically via a speech path.

A bell key is backed by an internal destination. The door intercom system can be addressed via an internal number.

A loudspeaker system can also be operated via the interface for door intercom systems.



See also:

"Special interfaces" Chapter in the Aastra 415/430 or Aastra 470. System Manual

2.3.3 Interface for general bell

Calls can also be routed to the general bell. Bells or lamps connected to the general bell interface signal calls which can be answered by anyone from any user's phone.

Coded ringing can be used to assign different ringing patterns to different destination persons or groups and, in this way, create a simple type of paging system.



Tip:

One analogue terminal interface per communication server can be reconfigured in such a way that it is also used for connecting a general bell. This eliminates the need for an external ringing voltage source.



See also:

"Special interfaces" Chapter in the Aastra 415/430 or Aastra 470. System Manual

3 Numbering plan

This Chapter features the different types of internal and external numbering plans available in the various systems. It explains the differences between internal numbering plans for the private network and external numbering plans for the public network. It tells you what you need to know when creating numbering plans for each particular network.

3.1 Numbering Plan Identifiers

The numbering plan is used to analyse numbers and allocate them to an addressable destination. Two types of numbering plans (Numbering Plan Identification, NPI) are relevant to the system:

- The public network uses numbering plan identifier E.164, which is defined and standardized by the ITU-T.
- Private networks use numbering plan identifier PNP (Private Numbering Plan). The internal numbering plan of a communication server or PINX is also of the PNP type, as is the private numbering plan supplied by the public network provider.

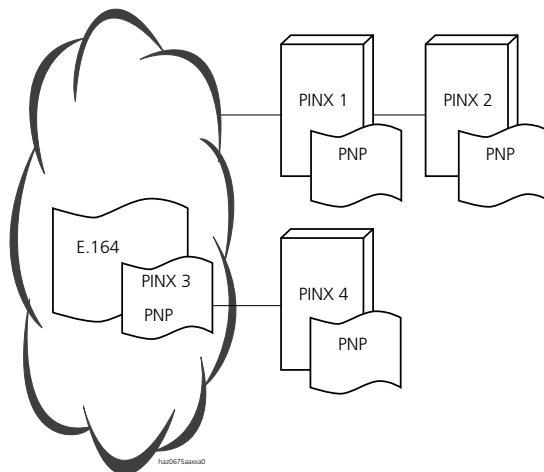

PINX 3 is a virtual PINX (Centrex)¹⁾

Fig. 17 Numbering plan identifiers in the public network and in the PISN (in PINXs)

¹⁾ depends on the network provider

Numbers in a numbering plan are analysed with the aid of the Type Of Number (or TON).

Numbering Plan Identifier E.164

Numbering plan E.164 comprises the following types of number:

Tab. 10 E.164 types of number

Type Of Number	Structure	Example
Subscriber	[SN]	624 11 11
National	[NDC] [SN]	32 624 11 11
International	[CC] [NDC] [SN]	41 32 624 11 11
Unknown	[NP] [NDC] [SN]	032 624 11 11
	[IP] [CC] [NDC] [SN]	0041 32 624 11 11

[SN] Subscriber Number (user number)

[NDC] National Destination Code (national destination code or toll area code)

[CC] Country Code (country code)

[NP] National Prefix (national prefix)

[IP] International Prefix (international prefix)

The national and international prefixes (in Switzerland 0 for national and 00 for international long-distance traffic) are not part of the type of number. Prefix digits are sometimes also referred to as trunk prefixes.

PNP Numbering Plan Identifier

The PNP numbering plan comprises the following types of number:

Tab. 11 PNP types of number

Type Of Number	Structure	Example
Level 0	[RIN]	1313
Level 1	[RP1] [RIN]	60 1313
Level 2 ¹⁾	[RP2] [RP1] [RIN]	62 60 1313

¹⁾ The system supports private networks up to and with Level 1

[RIN] Regional Intern Number: all destination numbers within a Level 0 region

[RP1] Regional Prefix 1: Prefix for a Level 1 region

[RP2] Regional Prefix 2: Prefix for a Level 2 region

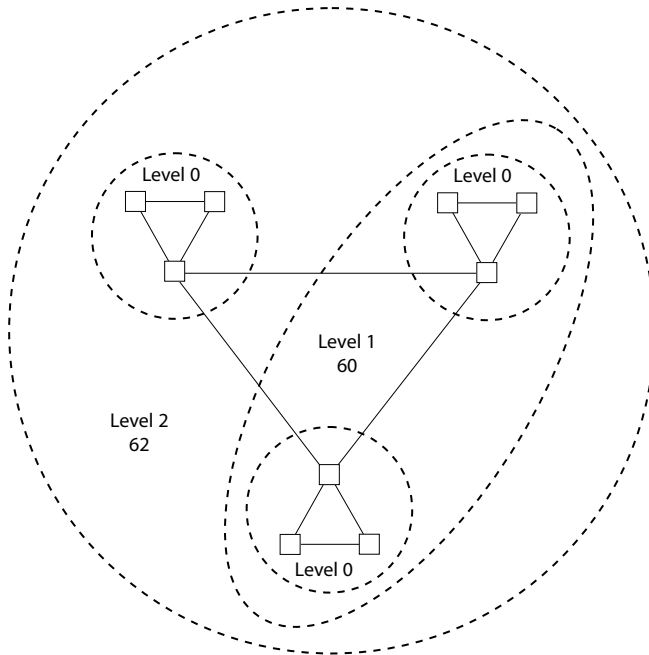

Fig. 18 Levels as per PNP definition

3.2 The System's Numbering Plan

The system's internal numbering plan is the numbering plan used for a stand-alone communication server or a PINX in a private network. The numbers entered in the numbering plan are used both to dial up call destinations in the communication server and to execute control functions.. Call destinations and functions are grouped into categories.

The internal numbering plan:

- Assigns number ranges to the categories.
- Allocates their numbers to call destinations and control functions, making them obtainable and executable respectively.

As far as the call destination numbers are concerned, the system's numbering plan is a PNP-type numbering plan.

3.2.1 Categories in the Numbering Plan

The allocation of categories to numbers and number ranges can be freely configured, provided a number of rules are observed. The default settings depend on the country.

Rules for an Internal Numbering Plan

Numbers are always interpreted starting from the left..

The various categories must be unequivocally separated through number allocation.. If, for example, the operator console has been allocated number 11, the numbers 11n cannot be allocated to any other categories. If, however, the operator console has been allocated the number 111, the numbers 112 to 119 can be allocated other categories.

Numbers within a category do not necessarily have to constitute a coherent range; instead, they can be spread over the entire number range (e.g.: user 200, 404, 550, 551, ...). However, for the purposes of clarity, we recommend that you define coherent ranges.

The number length is variable and can consist of 1 to 12 digits. Numbers with more than 12 digits will be truncated from the right.

Tab. 12 Categories in the system's numbering plan with allocated numbers

Category		Number / Number Range		
Name	Explanation	Number ¹⁾	Number range	Explanation
<i>Exchange access, Business</i>	Call charges are added up on the <i>Voice calls, business or Data calls business</i> cumulative counter.	0	<ext. call No.>	Prefix, truncated before dialling out into the network
<i>Exchange access, Private</i>	Call charges are added up on the <i>Voice/Data calls, private</i> cumulative counter.	10	<ext. call No.>	Prefix, truncated before dialling out into the network
<i>Transfer</i>	The operator console is stored under this number	11	–	
<i>Emergency number</i>	This number is assigned an emergency number destination under which three destination numbers are stored (depending on the switch group and switch position).	12	–	Up to 10 emergency numbers can be defined, all of them assigned the same emergency number destination.

Category		Number / Number Range		
Name	Explanation	Number ¹⁾	Number range	Explanation
<i>Cost centre selection</i>	The call charges are explicitly allocated to the selected cost centre.	13	<CC No.> <ext. call No.>	Prefix, truncated together with the CC No. before dialling out into the network
<i>Internal users</i>	Internal users of the system. The users are assigned one or more terminals.	20 to n or 200 to n ²⁾	–	
<i>Route selection</i>	Routes the outgoing call via the selected route	170 to n ³⁾	<ext. call No.>	Prefix, truncated before dialling out into the network
<i>User group</i>	User groups can be selected internally, directly with these numbers	860 to n ³⁾	–	
<i>AMC Controller</i>	Internal number of the AMC Controller.	897	–	
<i>Remote maintenance access PPP</i>	Selects the configuration interface via PPP	898	–	
<i>Voice mail</i>	Internal number of the Basic/Enterprise voice mail system. To activate a mailbox a call is rerouted to this number.	899	–	Only one voice mail number can be created.
<i>Abbreviated dialling</i>	Other, user-definable numbers are stored under these numbers	7000 to 7999	–	
<i>Door intercom system</i> ⁴⁾	Selects the door intercom	Not allocated	–	
<i>Control output</i>	For switching external equipment	Not allocated	–	
<i>Call Distribution Elements</i>	Call distribution elements can be selected internally, directly with these numbers	Not allocated	–	
<i>PISN users</i>	Users on another PINX in the PISN	Not allocated	–	
<i>Own region prefix</i>	Level 1 prefix for the region allocation of a PINX in the PISN	Not allocated	–	Prefix, truncated on detection
<i>* - substitute</i>	Substitute digit for pulse dialling phones without *-key	Not allocated	<Function code>	

1) Default settings for Switzerland

2) Depends on the number of terminal interfaces installed.

3) Depends on the type of communication server

4) Only with Aastra 415/430 and if the corresponding number of ODAB card(s) is fitted

3. 2. 2 Exchange Access Categories

Tab. 13 Exchange access categories in the internal numbering plan

Category		Name		
Name	Explanation	Number ¹⁾	Number range	Explanation
Exchange access, Business	Call charges are added up on the Voice calls, business or Data calls business cumulative counter.	0	<ext. call No.>	Prefix, truncated before dialling out into the network
Exchange access, Private	Call charges are added up on the Voice/Data calls, private cumulative counter.	10	<ext. call No.>	Prefix, truncated before dialling out into the network
Cost centre selection	The call charges are explicitly allocated to the selected cost centre.	13	<CC No.> <ext. call No.>	Prefix, truncated together with the CC No. before dialling out into the network
Route selection	Routes the outgoing call via the selected route	170 to n ²⁾	<ext. call No.>	Prefix, truncated before dialling out into the network

¹⁾ Default settings for Switzerland

²⁾ Depends on the system type

A call can be transmitted to the public network by selecting a prefix from one of the exchange access categories.

The cost type (Business, Private), cost centre (cost centre selection) or route (route selection) is determined according to the prefix selected.

Route selection prefixes are the internal call numbers of the routes.

Route selection can also be used for routing in the private leased-line network.

3. 2. 3 Category for abbreviated dialling

Tab. 14 Abbreviated dialling category in the internal numbering plan

Category		Name	
Name	Explanation	Number ¹⁾	Explanation
Abbreviated dialling	Other, user-definable numbers are stored under these numbers	7000 to 7999	

¹⁾ Default settings for Switzerland

Abbreviated dialling numbers facilitate the exchange traffic for numbers that are frequently used. They can also be used to activate functions via */# function codes more quickly.

An internal or external call number or a function code and a name can be stored under any abbreviated dialling number

Stored Numbers

If an external number is stored, the exchange access prefix must also be entered at the same time. Prefix and number must be separated with a hyphen. The hyphen ensures that when the number is dialled via a line key, the exchange access prefix is truncated.

Only the front portion of a number can be entered at any time. The rear portion must then be suffix-dialled manually. Example:

The number 0-001212 and the name "NY" (for New York) are stored under the abbreviated dialling number 7500. Any user who wants to call Manhattan, New York, simply dials "NY" by name, then adds the local number.



Aastra Intelligent Net:

In an AIN with nodes in different countries the abbreviated dialling numbers must always include the international prefix (e.g. 00) and the country code (e.g. 41). (Example: 0-0041326553333). This is necessary as the national portion of the number may well be identical in different countries. This prevents conflicts in the call routing and call number display (CLIP).

Name

The name is used:

- To dial by entering the name rather than the call number (dialling by name).
- To display the name on the user's own system phone when the CLIP number of an incoming call matches the number stored under the abbreviated dialling (see ["Replicating the Name Display in the Communication Server"](#), page 74).

Digit Barrings and Exchange Access Rights

When an external destination is dialled via an abbreviated dialling number the number stored bypasses the digit barring and the exchange access authorization.

When an external destination is dialled using dialling by name via abbreviated dialling, only the exchange access rights are bypassed (more on digit barrings and ex-

change access rights see "[Digit barring](#)", page 191 and "[Exchange access](#)", page 201).

3.2.4 Category for emergency number

Tab. 15 Category for emergency number

Category		Name	
Name	Explanation	Number ¹⁾	Explanation
Emergency number	This number is assigned an emergency number destination under which three destination numbers are stored (depending on the switch group and switch position).	12	Up to 10 emergency numbers can be defined, all of them assigned the same emergency number destination.

¹⁾ Default settings for Switzerland

A total of 10 emergency numbers can be created in the numbering plan. The emergency numbers are used to quickly dial an emergency number destination. Up to three internal or external destination numbers can be stored under the emergency number destination.

Emergency number destination

A total of 50 emergency number destinations with three destination numbers each can be configured. A separate emergency number destination can also be assigned to each terminal. This destination takes priority over the destination assigned in the system configuration.

Stored destination numbers

A destination number can be stored for each of the three switch positions of switch groups 1 to 20. Dialling an emergency number then automatically dials one of the three destination numbers (for more on the switch groups see "[Switch Groups](#)", page 129).

Entering the destination numbers is subject to the same rules as for abbreviated dialling.



Aastra Intelligent Net:

In an AIN the nodes can be located in different countries, which means it makes sense to enter in the numbering plan the emergency number normally used in each country. Depending on the assigned emergency destination and the switch position of the configured switch group the corre-

sponding destination number is then dialed whenever the emergency number is dialed. The assignment of the emergency number destination is configured for each node.

Digit Barrings and Exchange Access Rights

The same rules apply as for abbreviated dialling

3.2.5 Category for internal users

Tab. 16 User category in the internal numbering plan

Category		Number / Number Range
Name	Explanation	Number ¹⁾
Internal users	Internal users of the system. The users are assigned one or more terminals.	20 to n or 200 to n ²⁾

¹⁾ Default settings for Switzerland

²⁾ Depends on the number of terminal interfaces installed.

3.2.5.1 Internal users

The numbers within this category are assigned one or more terminals. The following terminal types are possible:

- *IP*
AstralIP system phones: These are system phones which are executed as pure software applications (softphones) or desk phones. A user can be assigned several desk phones, but only one softphone.
- *DSI-AD2*
Aastra digital system phones
- *DECT*
Aastra, 9d or GAP cordless phones: DECT phones must be logged on to the system using a logon procedure. This is done using the *Log on cordless phone* button in the terminal configuration. Only one DECT phone can be assigned per user.
- *Analogue*
Analogue terminals (phones, fax, etc.)
- *Aastra SIP*
AastraSIP terminals

- *Default SIP*
Standard SIP terminals
- *GSM*
See "Mobile phones", page 52
- *Virtual*
See "Virtual terminals", page 59
- *BRI-S bus*
Terminals on the S bus (ISDN terminals, PC cards, etc.)
- *AMC*
(See "Aastra Mobile Client (AMC)", page 56)

If an internal user is assigned a name, the user in question can be dialled internally by entering the name instead of the call number (dialling by name), and the name is displayed on the destination user's terminal on the system's own communication server, or another PINX in the PISN (CNIP).

3. 2. 5. 2 Mobile phones

Although the communication server does not have a GSM receiver, mobile phones can be connected to Aastra 400. The mobile phone is assigned to a user and can be reached internally using his user number. If the mobile phone user dials a call number specially set up in the communication server, he can execute certain functions via */# function codes (see [Tab. 375](#)) or make internal/external calls.

With the Aastra Mobile Client application for mobile phones all the main telephony functions are available with menu prompting.

Integration of mobile phones

The integration of mobile phones requires one *Mobile Phone Extension* licence per mobile phone. There are two steps to mobile phone integration, which contains the following features:

Integration step 1

- The mobile phone is assigned to a user and can be reached internally using his user number.
- If the integrated mobile phone user is assigned a direct dialling number, he can also be reached from the outside.

- The status of assigned user is monitored and displayed internally (e. g. on team keys). This is of course possible only for "logged in mobile phones" or for calls to integrated mobile phones set up via the internal user number.
- If the user of the integrated mobile phone calls an internal user on his direct dialling number, the called party is shown the CLIP of the integrated mobile phone's internal call number.
- The external user of the integrated mobile phones can dial in using specially set-up direct dialling numbers for which *Mobile phone integration* is configured as the CDE destination; once the external user has been authenticated he obtains the internal dialling tone. He can then carry out specific functions via */# function codes in prefix dialling or make internal/external calls. Several such direct dialling numbers can be set up for each communication server or AIN. This can help to save considerable roaming charges in an AIN that covers several countries.

Integration step 2

Suffix dialling functions such as enquiry calls or setting up a conference are also possible. This requires special DTMF receivers which must be activated throughout the connection. This in turn requires DSP resources. This means that the following prerequisites are needed so that the functions of integration step 2 can be used:

- The number of DTMF receivers required must be covered with GSM channels in the DSP configuration (CM_2.1.3_ *DSP configuration* tab). The number of assignable GSM channels differs depending on the configuration server and DSP (see Aastra 415/430 and Aastra 470 System Manual).
- If all GSM channels are busy, the functions of integration level 2 for the current call connection are not available.
- The enhanced functionality must be assigned to each mobile phone in the terminal configuration (CM_4.2_ *mobile phone settings*, Parameter *Extended unctionality* = Yes).



Aastra Intelligent Net:

The DSP resources must be made available at the node through whose network interface there is a communication server–mobile phone connection.



See also:

An overview of the function codes supported at integration levels 1 and 2 can be found in the "Mobile Phones on Aastra 400" User's Guide.

Automatic authentication of the integrated mobile phone

If the *CLIP authentication* parameter is set on *Yes* in *CM_4.2_Mobile phone settings* the integrated mobile phone is automatically authenticated using the CLIP, and the user obtains the internal dialling tone after a ring-back tone.



Note:

For security reasons automatic authentication is not used with "Break-in" or "Special Arrangement" situations as the incoming CLIP is not PSTN-verified in such cases. There may be cases however (especially with SIP providers) where the CLIP is received as "verified" when in fact it is not. An unauthorized person can then dial into the communication server and make calls or carry out certain */# procedures. After a first start automatic authentication is switched off.

In the case of a connection via analogue or SIP network interfaces the CLIP is normally received "unchecked". To allow automatic authentication of the integrated mobile phones nonetheless, the parameter *CLIP authentication even if CLIP isn't screened* must be configured to *Yes* in the corresponding trunk group (default setting = no).

Manual authentication of the integrated mobile phone

If the *CLIP authentication* parameter is set to *No* in *CM_4.2_Mobile phone settings*, the integrated mobile phone is authenticated manually using the following procedure:

1. The user of the integrated mobile phone dials a direct dialling number specially set up.
2. He obtains: a ring-back tone followed by a special authentication tone.
3. Input: <Internal user number> * <user PIN> #
4. He obtains: Internal dialling tone
5. The user of the integrated mobile phone can now make an internal/external call or execute certain functions via */# function codes.



Note:

For both automatic and manual authentication the user PIN must be changed first. The default value "0000" is not permitted.

System configuration

Tab. 17 Configuration in AMS

Parameter	Parameter value	Remarks
<i>Route</i>	<Route number>	<ul style="list-style-type: none"> This route is used if the integrated mobile phone's internal call number is dialled and an external call is then made to the stored mobile number.
<i>Mobile number</i>	<Call number>	<ul style="list-style-type: none"> The mobile phone's external call number is entered here.
<i>Use CLIP for authentication</i>	<Yes / No>	<ul style="list-style-type: none"> If this parameter value is set on <i>Yes</i>, the call number and password do not have to be entered to authenticate the integrated mobile phone.
<i>CLIP selection</i>	<Normal / CLIP from User>	<ul style="list-style-type: none"> This parameter influences the CLIP display to integrated mobile phone user dialled via his internal call number.
<i>Enhanced functionality</i>	<Yes / No>	<ul style="list-style-type: none"> The enhanced functionality requires DSP resources (GSM voice channels).
<i>CLIP authentication even if CLIP isn't screened</i>	<Yes / No>	<ul style="list-style-type: none"> Trunk group setting: Allows the automatic authentication of the integrated mobile phone via analogue or SIP network interfaces.
<i>Enhanced function for directly incoming calls</i>	<Yes / No>	<ul style="list-style-type: none"> Trunk group setting: Allows the use of features of integration level 2 if mobile phone integration is made with separate lines to the provider (depends on the provider).
<i>MWI route</i>	<Route number>	<ul style="list-style-type: none"> Route for MWI signalling (new voice mail voice message) to the integrated mobile phone.
<i>MWI CLIP</i>	<CLIP No.>	<ul style="list-style-type: none"> The CLIP for MWI signalling (new voice mail voice message) to the integrated mobile phone is entered here. (input format the same as an external call number e. g. 00326553827). The CLIP is transmitted in accordance with the <i>Transit CLIP format</i> parameter for trunk group settings.



Note:

In the case of an external call to an integrated mobile phone the caller's CLIP is always transmitted to the mobile phone as redirecting information. This also applies to external calls to a user who has redirected to an integrated mobile phone. In this case the parameter *Send redirecting information* must be set on *Yes* in the trunk group settings and "Special Arrangement" must be activated by the network provider.

**Tip:**

The mobile phone integration described above is not limited to mobile phones; it can be used in principle for any external users.

**See also:**

A separate User's Guide is available for the mobile phones on Aastra 400. It includes an overview of the functions that can be carried out using mobile phones.

3. 2. 5. 3 Aastra Mobile Client (AMC)

The Aastra Mobile Client is an application for the most common mobile phones with open operating systems. It means that the main telephony functions are available through menu prompting.

One *AMC Extension* licence is required for each Aastra Mobile Client. This licence also includes the *Mobile Phone Extension* licence.

To set up an Aastra Mobile Client, proceed as follows:

1. Purchase a *AMC Extension* licence and enter the licence code in AMS. In addition to the licence code an Aastra Mobile Client access code is also printed out. You will need this access code later on for the Aastra Mobile Client administration (see item 9).
2. Configure a sufficient number of GSM channels in the DSP configuration.
3. In the direct dialling plan configure a direct dialling number with *Mobile phone integration* as the CDE destination.
4. Create a user and assign him a mobile phone.
5. Change the PIN of the user you have just created.
6. Configure the terminal data of the mobile phone in AMS as shown in [Tab. 17](#). The *Extended functionality* parameter must be set to *Yes*.
7. Restart the communication server to activate the licence and the changes to the DSP configuration.
8. On the licence server start the Aastra Mobile Client administration.
9. Enter the EID No. and the Aastra Mobile Client access code (see item 1).
10. Configure the parameter for the Aastra Mobile Client as shown in [Tab. 18](#) by clicking the *Edit* button. Overlapping parameters must match the AMS configuration.
11. Save and transmit the data and click the "+" button to expand the view.

12. Click the [Send download link](#) button to send an SMS with a download link for the Aastra Mobile Client to the mobile phone.
13. Install the Aastra Mobile Client on the mobile phone.
14. Click the [Send licence](#) button to send an SMS with the licence to the mobile phone.
15. Restart the Aastra Mobile Client on the mobile phone to activate the licence.
16. Click the [Send configuration](#) button to send an SMS with the Aastra Mobile Client configuration to the mobile phone.
17. Restart the Aastra Mobile Client on the mobile phone to activate the configuration.

The Aastra Mobile Client is now set up and ready for you to use.

Tab. 18 Configuration in the Aastra Mobile Client administration on the licence server.

Parameter	Parameter value	Remarks
<i>Mobile number</i>	<Mobile number>	<ul style="list-style-type: none"> • Mobile number in canonical format (e. g. +41793130688).
<i>Description</i>	<Description>	<ul style="list-style-type: none"> • Free text field
<i>E-mail address</i>	<Download / SMS>	<ul style="list-style-type: none"> • If an e-mail address is entered here, the download link is sent via e-mail instead of SMS.
<i>Configuration type</i>	<E-mail address>	<ul style="list-style-type: none"> • Here you can choose whether the configuration data is to be sent via SMS or whether the client itself is to download the configuration using the Aastra Mobile Client access key.
<i>Mobile phone platform</i>	<Select the platform from the list>	<ul style="list-style-type: none"> • All the mobile phone platforms (operating systems) currently supported are listed here.
<i>Dial-in number</i>	<DDI number>	<ul style="list-style-type: none"> • Direct dialling number specially set up in canonical format, with <i>Mobile phone integration</i> configured as CDE destination (e. g. +41326553867).
<i>DTMF delay [ms]</i>	<Delay time>	<ul style="list-style-type: none"> • Delay time after connection setup until the Aastra Mobile Client sends DTMF characters.
<i>Auto login</i>	<Check box>	<ul style="list-style-type: none"> • Activate for automatic authentication with CLIP. • Deactivate for manual authentication with entering the user call number and user PIN.
<i>User call number</i>	<User call number>	<ul style="list-style-type: none"> • Internal user who is assigned the mobile phone in the communication server.
<i>PIN</i>	<User PIN>	<ul style="list-style-type: none"> • PIN of the user who is assigned the mobile phone in the communication server.
<i>Force</i>	<Check box>	<ul style="list-style-type: none"> • Activate if the PIN is to be transmitted automatically. • Deactivate if manual PIN input is required.

Parameter	Parameter value	Remarks
<i>Extended DTMF</i>	<Check box>	<ul style="list-style-type: none"> Activate if the mobile service provider supports the DTMF characters "ABCD". In this case the call numbers are transmitted to the communication server in canonical format. Dialling is then quicker.
<i>Exchange access, Business</i>	<Exchange access digit	<ul style="list-style-type: none"> Digit defined in the system's numbering plan for <i>Exchange access, business</i>. Used to replace the "+" of the canonical call number if the <i>Enhanced DTMF</i> parameter is not activated.
<i>International prefix</i>	<International prefix>	<ul style="list-style-type: none"> Used to replace the "+" of the canonical call number if the <i>Enhanced DTMF</i> parameter is not activated.
<i>MWI CLIP</i>	<CLIP No.	<ul style="list-style-type: none"> CLIP for MWI signalling (new voice mail voice message) to the integrated mobile phone user in canonical format (e. g. +41326553827).
<i>Voice mail No.</i>	<Voice mail No.>	<ul style="list-style-type: none"> Internal number of the voice mail system (e. g. 899). If no number is configured, the <i>Voice mail</i> function is not offered on the Aastra Mobile Client.
<i>Personal call routing</i>	<Check box>	<ul style="list-style-type: none"> Activate if personal call routing is used in a One Number configuration. If the check box is deactivated, the <i>Personal call routing</i> function cannot be selected on the Aastra Mobile Client.
<i>Take number</i>	<User number>	<ul style="list-style-type: none"> If a user number is configured here, a call made to that user can be taken on the Aastra Mobile Client during the ringing phase or during a call using the <i>Take</i> function. If no user number is configured, the <i>Take</i> function is not offered on the Aastra Mobile Client. A user's own number can also be entered in a One Number configuration.
<i>Redkey</i>	<Parameter>	<ul style="list-style-type: none"> If the system is connected to an alarm server via ATAS, the <i>Redkey</i> function can be used to trigger an alarm. The parameter is added to the alarm and may contain up to 32 characters/digits. If the parameter remains blank, the <i>Redkey</i> function is not offered on the Aastra Mobile Client.
<i>Dial mode</i>	<Retain local settings / Parallel mode / Always Aastra MC>	
<i>Start automatically</i>	<Retain local settings / Off / On >	
<i>Minimum external call number length</i>	<Retain local settings / Off / 1...10 >	
<i>Function table</i>	<Select from list>	

Parameter	Parameter value	Remarks
<i>LCR</i>	<Check box>	
<i>LCR table</i>	<Select from list>	
<i>LCR/Feature Download Interval [days]</i>	<days>	



See also:

A separate User's Guide is available for the Aastra Mobile Client. It contains a list of the mobile phone operating systems supported as well as a short description of the telephony functions provided that can be operated using menu keys.

3.2.5.4 Virtual terminals

Virtual terminals respond in the same way as analogue internal terminals except that they

- do not physically occupy a port as there is no hardware involved,
- do not require a B channel.

Other properties

- Virtual terminals are capable of sending and receiving messages via the third-party CTI interface.
- A user who has been assigned only one virtual terminal is referred to as a virtual user.
- When the caller dials a virtual user he obtains the ring-back tone or the busy tone (if the user is already in a call).
- Virtual users belong to the group of users with their own DDI number, the maximum number of which is restricted by the system limits per system.
- Virtual users have their own recall time, which can be set throughout the system. It is used if no recall time is defined in the user setting (see also "[Recall](#)", [page 379](#)).

Application examples:

- During an explicit call transfer without prior notice to a virtual user a call can be parked for up to 900 seconds and then transferred using *86 <User No.>.

- To integrate a PISN user into a user group, it is possible to accept a virtual user in the user group using a CFNR to the PISN user.
- In third-party CTI applications virtual users can be used to send and receive messages.

3.2.6 PISN users

Tab. 19 User category in the internal numbering plan

Category		Number / Number Range
Name	Explanation	Number ¹⁾
PISN users	Users on another PINX in the PISN	Not allocated

¹⁾ Default settings for Switzerland

This category comprises users who belong to the same PISN but are connected to a different PINX. They can also be users of a virtual PINX.

The numbers of user groups, call distribution elements, abbreviated dialling destinations, routes or door intercoms can also be entered as PISN users, besides the numbers of internal users.

Entering PISN Users

There are two ways of entering PISN users:

- A PISN user's call number is entered in full and unequivocally (Fig. 19, PINX 2).
- One number with wildcards is entered for several PISN users (group of PISN users, Fig. 19, PINX 1, PISN users D and E).

These variants can also be combined (Fig. 19, PINX 1).

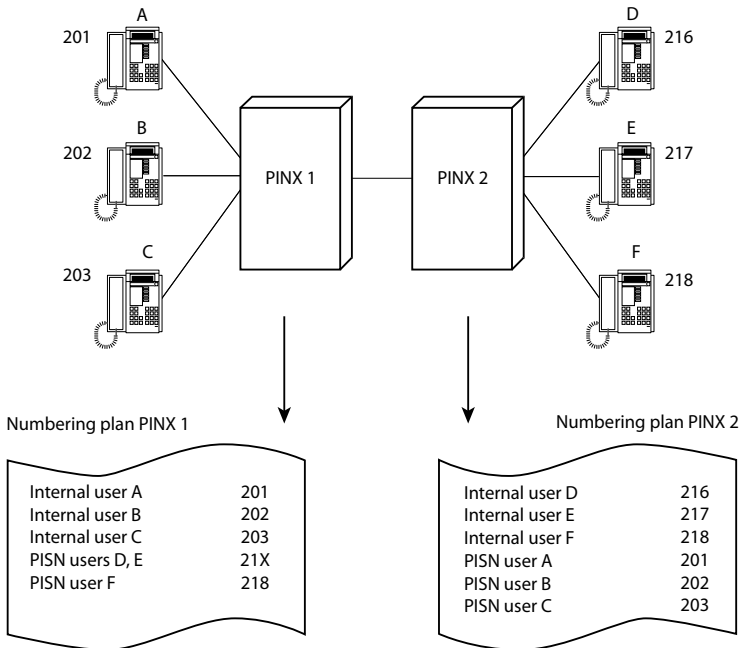

Fig. 19 PISN users entered with and without wildcards

Entering the Number of a PISN User in Full

A complete PISN user number unequivocally identifies a user at another PINX or a virtual user.

Each unequivocal number of a PISN user can be allocated a name in the user configuration. This enables:

- these users to be dialled by entering the name rather than the call number (dialling by name)
- the name of a virtual PISN user to be displayed (CNIP)

Entering Wildcards for a Group of PISN Users

A number with wildcards identifies a group of PISN users (Fig. 19, PINX 1). They can be:

- the internal users of one or more PINXs
- the PISN users of another region

The wildcard is entered as an upper case (e.g. 21X).

This method of entering PISN users helps to reduce the number of entries made. Moreover, not all the changes made to the internal users of a PINX need to be updated in the other PINXs. However, neither the call numbers nor the names of the individual users in the group are stored in a phone book (it is not possible to retrieve the number from a phone book nor is dialling by name possible, except if the number and name are also stored locally in a private phone book).



Tip:

It is advisable to enter PISN users first with wildcards in an initial stage so that the numbering plan is quickly and transparently available throughout the PISN, and is also already operational.

All the PISN users to be available using dialling by name can then be entered individually at a later stage

Entering a Regional Prefix

If an individual or group entry belongs to another PISN region, the entry for the PISN user must be preceded by the regional prefix.

Example of Entering PISN Users

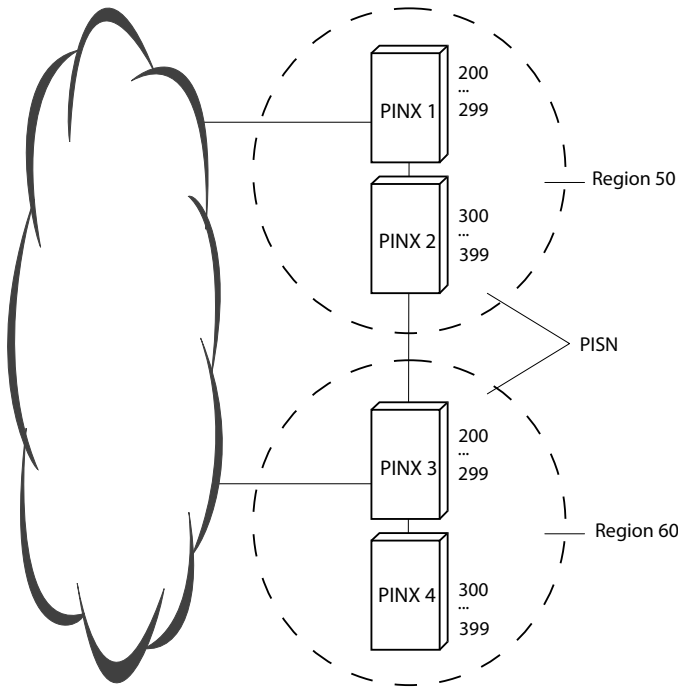

Fig. 20 PISN with two regions

Tab. 20 Entering PISN users in PINX 2

Variant	Number of entries	PINX 1	PINX 3	PINX 4
Number in full	300	200,201...299	60200, 60201...60299	60300, 60301...60399
Numbers partly with wildcards	12	20X, 21X...29X	602XX	603XX
Numbers with maximum possible wildcards	2	2XX	PINX3 and PINX 4 60XXX	
Combination: number in full and number with wildcards	5	2XX, 211	60XXX, 60211, 60311	

3.2.7 Separate Regional Prefix Category

Tab. 21 Category for separate regional prefix in the internal numbering plan

Category		Number / Number Range	
Name	Explanation	Number	Explanation
Own region prefix	Level 1 prefix for the region allocation of a PINX in the PISN	Not allocated	Prefix, truncated on detection

This regional prefix allocates a PINX to a PISN region..

The PINX compares its own regional prefix entry with the first few digits of the call numbers of the following calls:

- All outgoing calls
- All incoming calls routed via a trunk group with the setting *Network type = private*

If the first few digits match up with the PINX's own regional prefix, they will be truncated.. The remaining number is then analysed and forwarded

3.2.8 Shared Numbering Plan

PISN users are structured in the internal numbering plans of the PINX.

From the PINX's viewpoint its own users are internal users and the users of the other PINXs are PISN users.

If two or more PINXs are structured in such a way that they split the users' number range among themselves, we talk of a shared numbering plan. Together they form a region, within which all users can be reached under the internal call number.

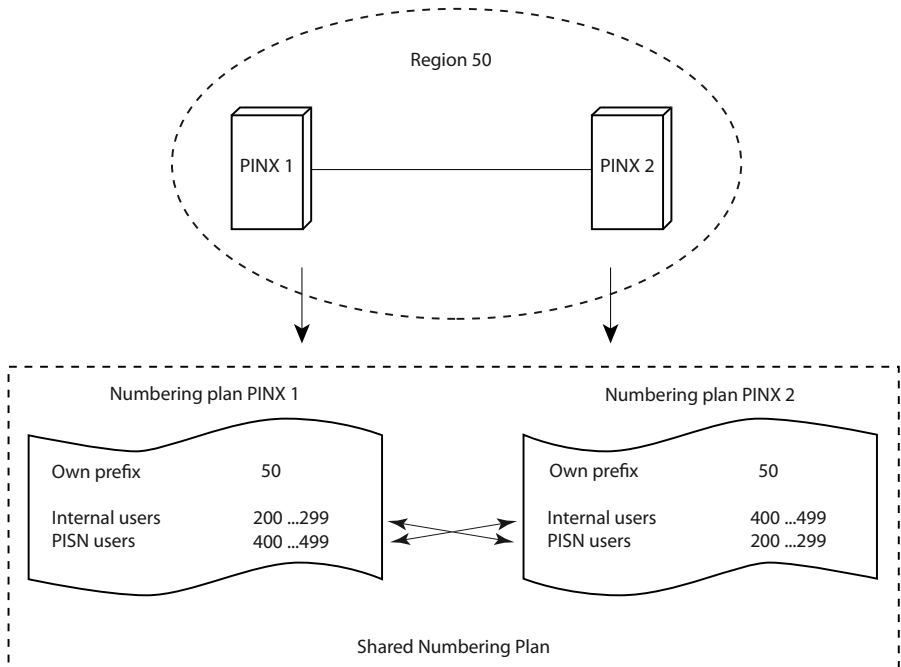

Fig. 21 Shared numbering plan: two PINXs share the numbers of a numbering plan.

3.2.9 PISN with different Regions

A PISN can be divided into several regions. Each region is identified by its regional prefix.

Users who call a user in a different region first dial the prefix of the destination region, then the internal number of the user they want.

Their specific regional prefix is specified in the internal numbering plan of each PINX.

The organization of the numbering plans does not depend on the PISN topology.

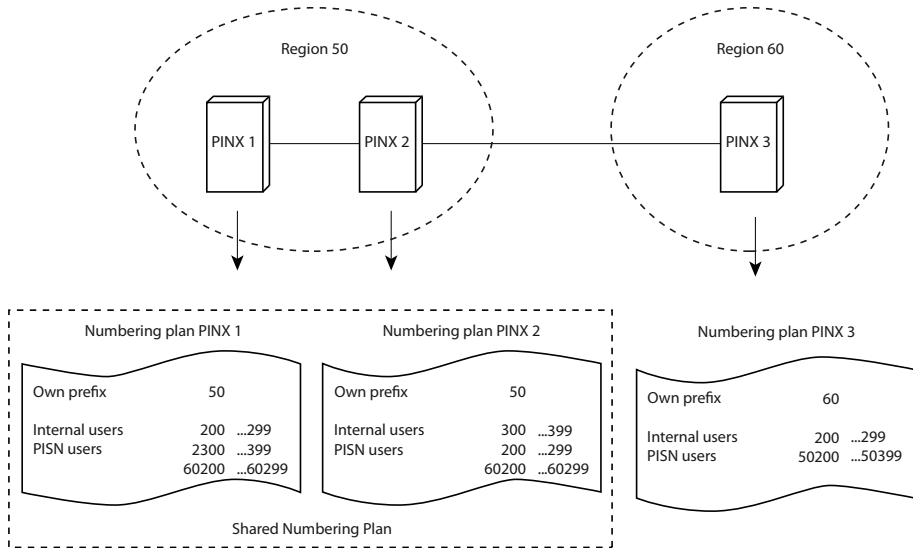

Fig. 22 PISN with two regions and shared numbering plan for Region 50

Entering a Regional Prefix

In the example above the PISN users of a different region are entered with the regional prefix (for example 60200 to 60299).

Another possibility is to define a route with call number 60 and to enter the PISN users without regional prefix (route method).

The user dials exactly the same number, for example 60250, but this time the call is routed as a route selection. It uses the route with call number 60 and not the one allocated to the PISN user in the user configuration. (In the example above the numbers would have to be distributed differently since number ranges cannot be assigned twice.)

4 Identification elements

Correctly identifying and displaying a call is the essential requirement for adequately implementing the system's networking philosophy. This Chapter looks at how the origin of a call is identified using different ringing tone patterns and how the caller's number (CLIP) or name (CNIP) is displayed. It describes how CLIP and CNIP displays are created under different system conditions, how they can be influenced, and how to suppress the CLIP display.

A call is identified firstly by the type of acoustic ringing (i.e. ringing pattern) and, secondly, by the display on the terminal.

The default values are selected in such a way that the ringing patterns and displays appear correctly in most cases. Changes to the settings are necessary only in exceptional cases.

4.1 Internal and External Ringing Patterns

The ringing pattern provides a means of identifying whether the call originates from within the PBX (internal call) or from the outside (external call). The rhythm of the ringing pattern differs in each case

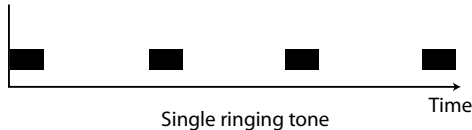

Fig. 23 Single ringing tone¹⁾

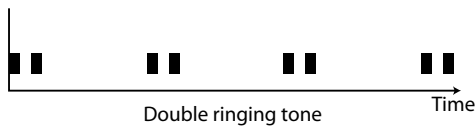

Fig. 24 Double ringing tone¹⁾

¹⁾ The way in which ringing patterns are assigned to internal and external calls varies from one country to the next.

Calls with the **Internal** ringing pattern:

- Calls from internal users
- Calls from the public network if *Ringing pattern = single ringing tone* is set in the terminal configuration (setting for analogue terminals only).
Calls from users from the private network (PISN users):
 - Calls from the private leased-line network
 - Calls from virtual network PISN users
- An enquiry call from a user with an exchange call on hold if the parameter *Ringing pattern at enquiry destination = internal* is set in the common settings of the user configuration (see "Hold (enquiry call)", page 365).

Calls with the **External** ringing pattern:

- Calls from the public network
 - if they do not originate from a virtual network PISN user and
 - if *Ringing pattern = automatic* is set in the terminal configuration (setting for analogue terminals only).
- An enquiry call from a user with an exchange call on hold if the parameter *Ringing pattern at enquiry destination = external* is set in the common settings (see "Hold (enquiry call)", page 365).

The *Ringing pattern at enquiry destination* setting is valid throughout the system.



Note:

Certain terminals which automatically answer calls (e. g. fax machines) are not able to interpret the double ringing tone correctly. With these terminals the configuration *Ringing pattern = automatic* can be used to force a situation where the single ringing tone is always used for all calls.

Alternative for the Aastra 5300, Aastra 5300ip series of system phones and the Aastra 2380ip IP softphone

Different ringing melodies can be configured separately in the terminal configuration for each system phone to help differentiate between internal and external calls. If the parameter *External ringing melody = 0*, the single and double ringing tone is used to make the distinction; otherwise, the configured ringing melodies. If no distinction is required, the identical melody can be entered in both places.

Identifying the Origin of a Call

If an incoming call's CLIP number corresponds to numbering plan identifier E.164, the system assumes that the call comes from the public network.

If an incoming call's CLIP number corresponds to numbering plan identifier PNP, the system assumes that the call comes from the PISN.

If the CLIP number's numbering plan identifier is unknown, the trunk group configuration is used to decide whether the call is signalled internally or externally (*NPI call unknown* setting).



See also:

"Numbering Plan Identifiers", page 43

4.2 Displaying Numbers (CLIP) and Names (CNIP)

During both the ringing phase and the call itself the caller's call number or name (or both) are shown on the terminal's display.

- The indication of the caller's phone number is referred to as CLIP (Calling Line Identification Presentation).
- The indication of the caller's name is referred to as CNIP (Calling Name Identification Presentation).

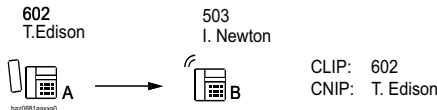

Fig. 25 CLIP and CNIP

When the destination user answers the call, the number or name of the destination user is transmitted and displayed to the caller:

- The indication of the number is referred to as COLP (Connected Line Presentation).
- The indication of the name is referred to as CONP (Connected Name Presentation).

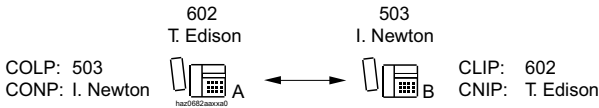

Fig. 26 COLP and CONP

These identification elements allow the use of other features such as logging unanswered calls on the destination user's call log; the destination user can then return the call by dialling the CLIP number.

These identification elements are available in digital networks and in some analogue networks. As CNIP and CONP are not supported by the public network, the system tries to replicate them by searching through the internal phone books for a number that matches the CLIP or COLP number. If there is a match, the name entered there is displayed (see "[Replicating the Name Display in the Communication Server](#)", page 74).

CNIP and CONP are supported in the private network under QSIG. They are both accepted and do not need to be recreated in the communication server.

The CLIP and COLP numbers also contain the information of the NPI numbering plan type and the TON Type of Number (see "[Numbering Plan Identifiers](#)", page 43). The system needs this additional information for a correct number analysis, particularly as a PINX in a PISN. It is not displayed on the user's terminal.



Note:

CLIP is presented on all the terminals with a display.

Exception: For CLIP display on analogue terminals the following conditions have to be met:

- In the terminal configuration, the parameter *Terminal supports CLIP* must be set to *Yes*.
- The terminal must support CLIP display.
- Restriction for Aastra 415/430: Different CLIPs can only be sent to 2 analogue terminals simultaneously.

CLIP Numbers Outside the Registered Number Range

Sometimes the CLIP number transmitted to the public network is not within the registered number range. Network providers have different ways of responding to this situation:

- The network provider uses the PINX master number as the CLIP number and sends it on to the destination user.
- The network provider sends the CLIP number received, on to the destination user. Usually this requires an agreement with the network provider (special arrangement).

In the following cases a PINX sends the CLIP outside the registered number range:

- If a freephone number (0800...) is to be displayed as the CLIP
- In the case of overflow routing via a different gateway PINX (see [page 246](#) and example in [Tab. 29](#)).
- In the case of break-out routing (see [page 251](#))
- If a break-in situation is to be forced

4.2.1 Displaying the CLIP

CLIP functions process incoming and outgoing calls.

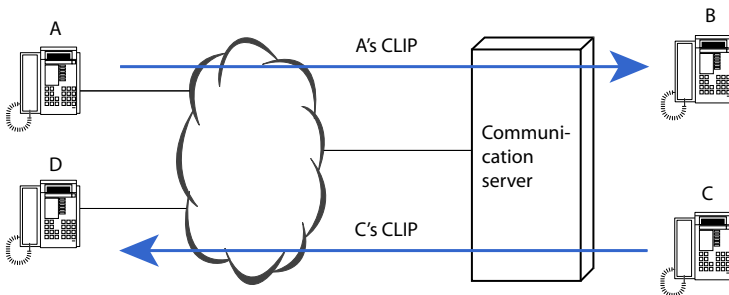

Fig. 27 CLIP of an incoming and an outgoing call

CLIP of an Incoming Call

User A calls user B:

User A sends his CLIP, which is received in the communication server by the trunk group, processed and displayed to user B.

For more details see as of [page 76](#).

CLIP of an Outgoing Call

User C calls user D:

User C sends his CLIP number, which is processed in the communication server. If there already is a direct dialling and a corresponding allocation, the CLIP number is adapted and sent to user D.

For more details see as of [page 76](#).

The default configuration has been selected so that the CLIP display is correct. The relevant settings do not normally have to be adjusted.

4.3 CLIP with Incoming Calls

The CLIP number of an incoming call is processed and presented in two stages:

- Analysis and processing of the CLIP number
- Presentation of the CLIP number on the destination user's terminal

4.3.1 Analysing and Editing the CLIP

The following information is necessary for specifying the CLIP properties in a PISN correctly. . This sub-chapter can be skipped in the case of the configuration of a stand-alone communication server.

The system analyses and adapts the CLIP number of an incoming call as accurately as possible so that the CLIP number is always displayed correctly, even in a PISN. For this purpose CLIP number prefixes such as regional prefix, prefix and code are evaluated, and the type of number adapted.

The tables below show how the system handles the type of number and the CLIP number of an incoming call.

Tab. 22 Handling a CLIP number with NPI-type PNP or unknown

TON of the CLIP number	Specific Regional prefix ¹⁾	Conversion
unknown, level 1, level 2	yes	Regional prefix is truncated, TON is set to <i>level 0</i> .
	no	CLIP number and TON remain unchanged
level 0	no	CLIP number and TON remain unchanged

¹⁾ CLIP number has a regional prefix that matches the separate PINX.

Tab. 23 Handling a CLIP number with NPI-type E.164

TON of the CLIP number	Prefix	Conversion
Unknown	International prefix	Prefix is truncated, TON is set to <i>international</i> , Further processing, see <i>TON = international</i>
	National prefix	Prefix is truncated, TON is set to <i>national</i> Further processing, see <i>TON = national</i>
	No prefix	CLIP number and TON remain unchanged
International	Country code that matches the separate PINX	Code is truncated, TON is set to <i>national</i> Further processing, see <i>TON = national</i>
	No matching country code	CLIP number and TON remain unchanged
National	Long-distance code that matches the separate PINX	Code is truncated, TON is set to <i>subscriber</i> .
	No matching long-distance code	CLIP number and TON remain unchanged
Subscriber		CLIP number and TON remain unchanged

See also the examples in "Examples of CLIP Displays in the PISN", page 90.

4.3.2 Presentation of the CLIP on the Terminal

Call from the Public Network

If a call originates from the public network, the prefix for *Exchange access, business* followed by a hyphen is added to the CLIP number (e.g. 0-333 33 33) so that the called party can call back simply by dialling the number displayed.

Call from a PISN User in a Virtual Network

If a call originates from a PISN user in a virtual network, the call number to the PISN user (*Call number* setting in the user configuration) is used to convert the CLIP number into the PISN user number and *NPI* is set to *PNP* (see also examples on page 98).

Destination is not a system phone

If the destination is not a system phone; the CLIP number is handled in the same way as with system phones but without adding a hyphen.

Calls with suppressed CLIP (CLIR)

If a caller uses the CLIR function to suppress his CLIP display to the called party, the system phone displays *Number suppressed* instead of the CLIP.

Calls without CLIP

Number unknown is displayed on the system phone for calls without CLIP.

4.3.3 Replicating the Name Display in the Communication Server

The communication server will try to assign a name to the CLIP number of an incoming call from the public network and to display that name on the system phone (CNIP). A search is therefore carried out in the communication server card files for a match for the CLIP number. The card files are searched in the following sequence:

- PISN user list
- Abbreviated dialling list
- Local card files of the system phones

A name will be displayed depending on the search result as shown in [Fig. 28](#).

CNIP and CONP are supported in the private leased-line network under QSIG. They are both accepted and do not need to be recreated in the communication server.

4.3.4 Flow charts for name identification (CNIP)

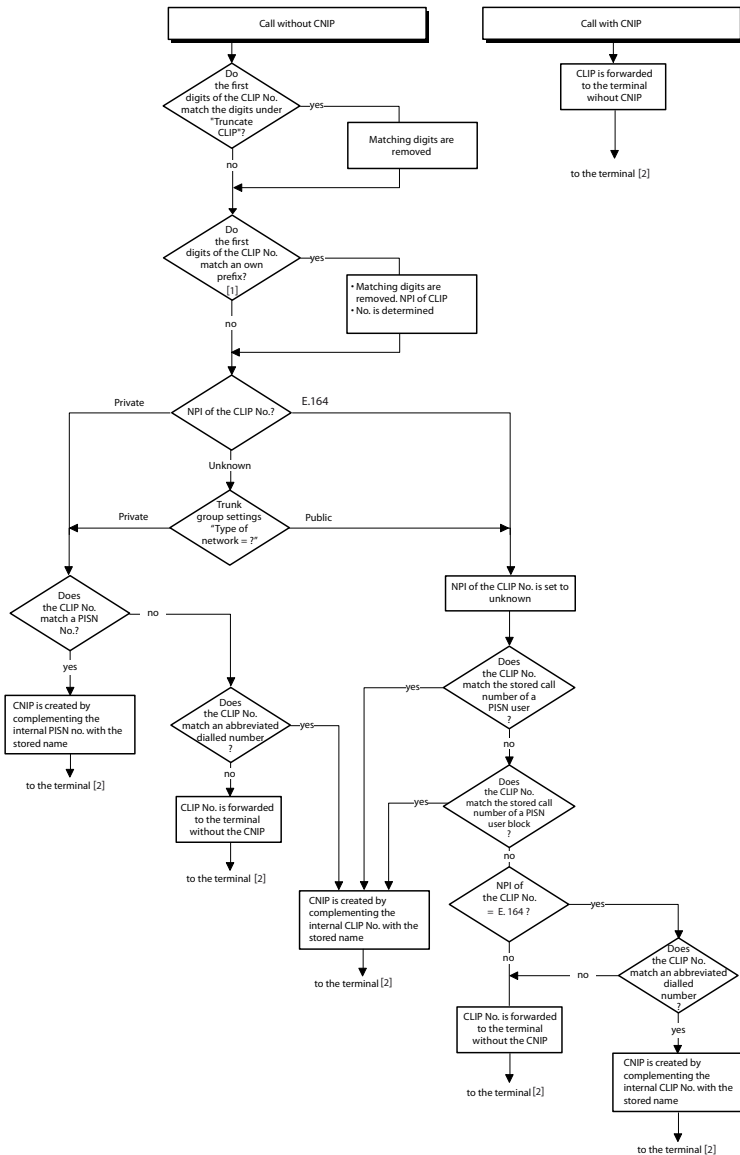

[1] Possible prefixes: own prefix, country code, area code or own regional prefix.

[2] Continues on Fig. 29.

Fig. 28 Analysis and processing of an incoming call in the communication server

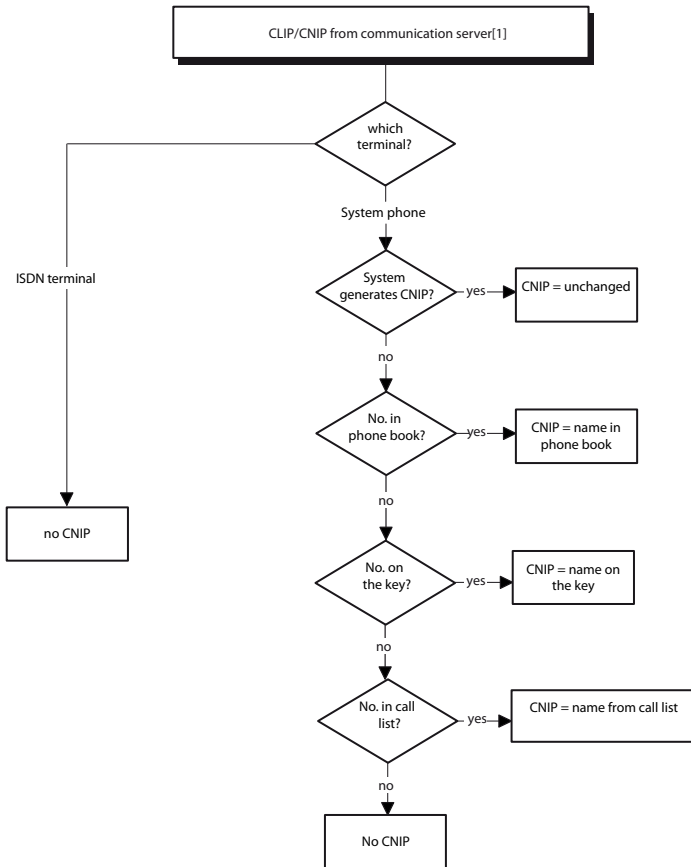

[1] From Fig. 28.

Fig. 29 Presentation of the CLIP / CNIP of an incoming call on the terminal

4.4 CLIP with Outgoing Calls

With an outgoing call the CLIP number is transmitted along with the NPI and TON information. In principle there are two possible variants for creating a CLIP number:

- The communication server creates the CLIP number automatically, based on the origin and routing of the call.
- A number is entered permanently as the CLIP number in the user configuration.

4. 4. 1 Creating the CLIP in the communication server

With the *Automatic CLIP = Yes* setting in the user configuration, the communication server generates a CLIP number. If there is a suitable DDI number for the calling user, that number will be used.

A suitable DDI number is a number in a direct dialling plan which

- is linked directly or through a user group to the calling user via a call distribution element, and
- is linked with the same trunk group via which the outgoing call is routed.

If there is more than one suitable DDI number, the lowest one is used.

The trunk group settings are used as the numbering plan identifier and type of number.

If there is no suitable DDI number, the trunk group settings are used for calls into the public network (Fig. 30), for calls into the private leased-line network it also depends how the automatic CLIP is set in the trunk group configuration (Fig. 32).

4. 4. 2 Entering a fixed CLIP

In practice a permanent CLIP number is used if the CLIP of the user concerned is always to remain the same in the public network, regardless of the path used for routing an outgoing call. Break-out is a typical application (see page 251).

If a call goes out to the public network, the permanent CLIP number is retained unchanged together with the numbering plan identifier NPI and the type of number TON, even if the call is routed via another PINX (see example on page 96).

The CLIP number required, the numbering plan identifier NPI and the type of number are entered in the user configuration. The *Automatic CLIP* setting, also in the user configuration, must be set on *No*.

E.164 is normally set for the numbering plan identifier NPI.

4. 4. 3 Suppressing CLIP / COLP (CLIR / COLR)

If *CLIR = Yes* has been set in the caller's user configuration, the information sent along with the CLIP and COLP numbers specifies that they are not to be displayed to the call's recipient (CLIR: Calling Line Identification Restriction, COLR: Connected Line Presentation Restriction). In this case the network provider does not forward the CLIP number to the recipient (the CLIP number may nonetheless be sent to a number of public authorities, such as the police, see also "Display CLIR", page 89).

The same setting is also used to prevent the name being displayed to the call's recipient. The suppression of CNIP (Calling Name Identification Presentation) and CONP (Connected Name Identification Presentation) is called CNIR (Calling Name Identification Restriction) and CONR (Connected Name Identification Restriction).

Depending on the network provider it may be necessary to subscribe to CLIR.

For each user CLIR can only be activated permanently or temporarily for one call (see "Suppression of the call number display", page 468).

4. 4. 4 CLIP flowcharts for Outgoing Calls

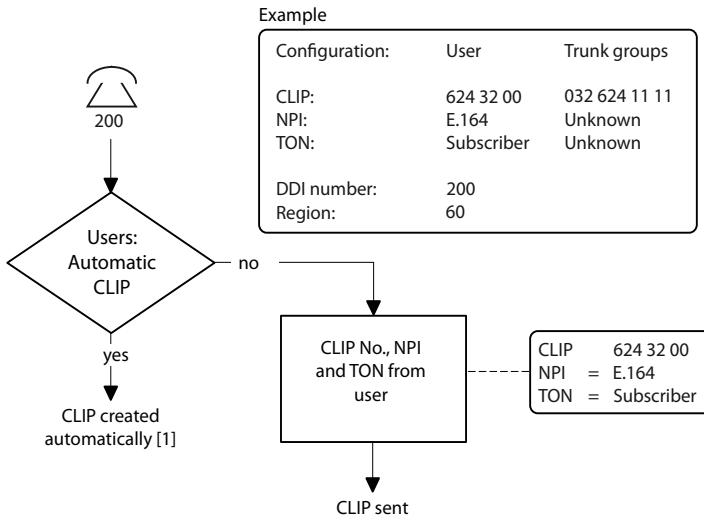

[1] Continues in Fig. 32.

Fig. 30 CLIP of an outgoing call to an external user in the public network

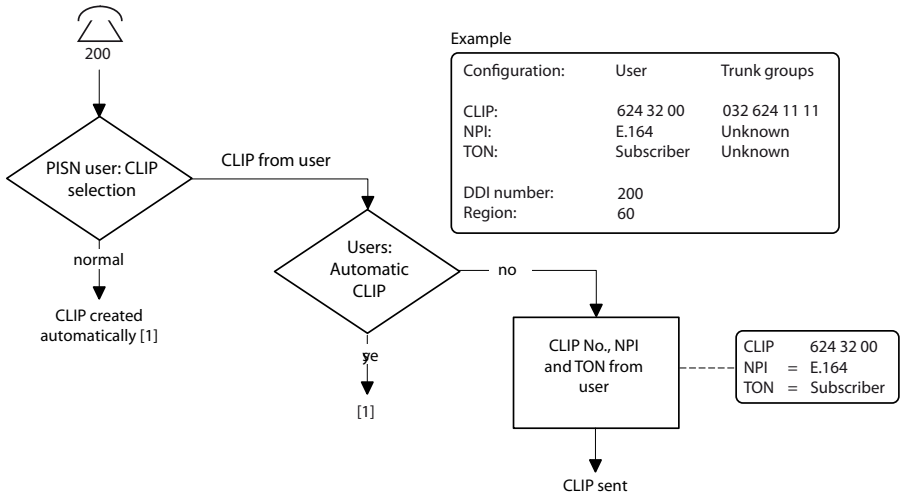

[1] Continues in Fig. 32.

Fig. 31 CLIP of an outgoing call to a PISN user

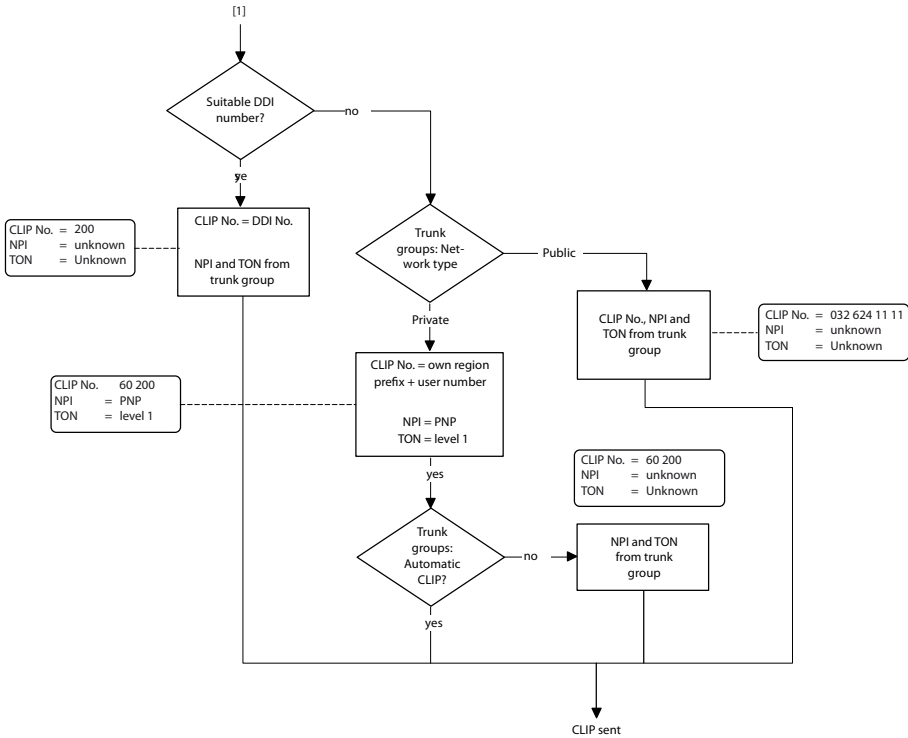

[1] From Fig. 30 or Fig. 31

Fig. 32 Creating an automatic CLIP for outgoing calls

4. 4. 5 CLIP Display with a Virtual Network PISN User

A public network user can be set up as a virtual PISN user in the communication server. Internal users will then perceive the user as another internal user: A call is signalled with the internal ringing pattern. The internal number can also be dialled for outgoing calls. Individual mobile user or entire number blocks can be integrated in this way.

Setting Up a Virtual Network PISN User

A PISN user is set up for this purpose (see "Numbering plan", page 90). Enter the public network user's full number under *External Number*. For outgoing calls the configured number will be dialled via the configured route instead of the dialled

PISN user number. This mechanism is similar to the one used for abbreviated dialling.

When the user calls up from the public network, his CLIP number will be compared with the numbers of all the PISN users. If there is a match, the called user is shown the PISN user number by way of CLIP instead of the CLIP sent from the public network.

4.5 Display for Call Forwarding Unconditional

When Call Forwarding Unconditional is activated, it is useful for users to know that the call was redirected, by whom and to whom. This means the called user is able to answer the call on behalf of the user who redirected the call to him. With this information the calling user is better prepared for the call. This redirecting information is available on system phones and ISDN terminals both internally and in private networks. If the public network provider supports the function (special arrangement), the redirecting information is also available to virtual PISN users and users in the public network.

4.5.1 Information displayed to the called user

The called user sees not only the caller's name and number but also that the call was redirected and who redirected it (redirecting information).

Example:

User A calls user B, who has redirected to user C. The display on an system phone at user C reads:

<CNIP A> / <CLIP A> *forwarded from* <CNIP B> / <CLIP B>

This redirecting information at user C is available for *CFU*, *CFB*, *CFNR* and *Call Deflection (CD)*. (With CD *forwarded from* is displayed instead of *deflected from*.)

4.5.1.1 Outgoing call with local call forwarding

The configuration possibilities for the redirecting information depend on the destination user:

If the destination user is

- an internal user in the local PINX, the redirecting information is always transmitted to the called user.

- a PISN user, a PISN user in a virtual network, an integrated mobile phone user or a public network user, you can select in the trunk group configuration whether the redirecting information is to be sent to the called user or suppressed (*Send redirecting information = Yes / No*).
- a public network user and if CLIR is activated at the user who carried out the redirecting, the called user will see neither the originator of the call nor that it has been redirected. This even though the calling user did not activate CLIR. To prevent this, you can set the *CLIR for redirected calls* parameter in the trunk group configuration to *No*.

In a call forwarding chain with several users the name/number of the first user in the chain is displayed as redirecting information to the called user.

4.5.1.2 Incoming call with CDE overflow

If in the event of a CDE overflow the call is routed from one call distribution element to another due to the entries under *CDE if busy* or *CDE if no answer*, the redirecting information provided to the called user depends on the new destination:

If the destination is

- an internal user or a user in a private QSIG network, the name/number of the CDE is transmitted.
- a virtual network PISN user, the direct dial number to which the call is made is transmitted.
- an external user in the public network, no redirecting information is transmitted.

4.5.1.3 Incoming call that is already redirected

The redirecting information is also available to the called user in the case of an incoming call redirected via a PISN user or a user in the public network. If the call is routed via a call distribution element it is useful in certain cases if the name/number of the CDE is displayed instead of the redirecting information. For this, set the parameter *Show redirecting information instead of CDE name* to *No* in the CDE configuration (*Default value = Yes*).

4.5.2 Information displayed to the calling user

The calling user sees not only the called user's name and number but also that the call is being redirected and to whom (redirecting information).

Example:

User A calls user B, who has redirected to user C. The display on an system phone at user A reads:

<CNIP B> / <CLIP B> *forwarded to* <CNIP C> / <CLIP C>

This redirecting information at user A is available for *CFU*, *CFB*, and *Call Deflection (CD)*. (With CD *forwarded to* is displayed instead of *deflected to*.)

4.5.2.1 Incoming call with local call forwarding

The caller's configuration possibilities for the redirecting information depend on the call's origin:

If the caller is

- a user in the local PINX, the redirecting information is always transmitted to the user who is calling.
- a PISN user, a PISN user in a virtual network or a user in the public network, you can select in the trunk group configuration whether the redirecting information should be sent to the calling user or suppressed (*Send redirecting information = Yes / No*).
- a public network user or if the user who redirected the call has activated COLR, the caller will not see that he is being redirected. If this setting is required only for internal redirected calls but not external ones, the *COLR for redirected calls* parameter in the trunk group configuration can be set to *No*.

In a call forwarding chain with several users the name/number of the last user in the chain is displayed as redirecting information to the calling user.

4.5.2.2 Incoming call with CDE overflow

If in the event of a CDE overflow the call is routed from one call distribution element to another due to the entries under *CDE if busy* or *CDE if no answer*, the redirecting information provided to the calling user depends on the new destination:

If the destination is

- an internal user or a user in a private QSIG network, the name/number of the CDE is transmitted.
- a virtual network PISN user or an external user in the public network, no redirecting information is transmitted.

4.5.2.3 Outgoing call with non-local redirection

The redirecting information is also available to the calling user in the case of an outgoing call that is not redirected via his own communication server but via a PISN user, an integrated mobile phone user, a virtual network PISN user or a public network user.

4.6 CLIP / COLP Settings

The following settings affect the CLIP and, by analogy, the COLP, too.

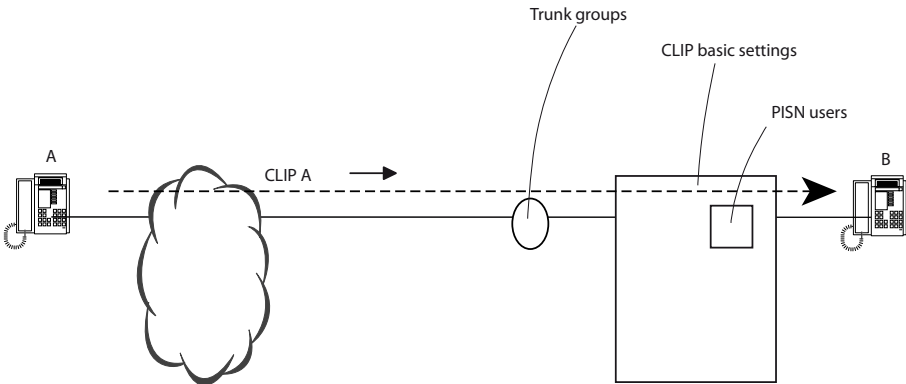

Fig. 33 CLIP incoming

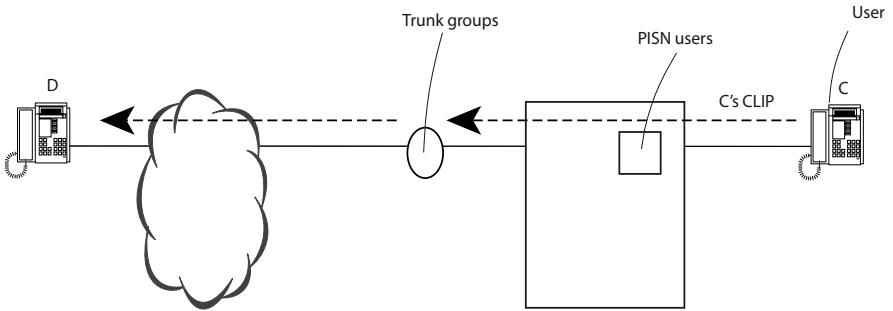

Fig. 34 CLIP outgoing

Tab. 24 CLIP related settings

Configuration Element	Parameter	Affect on CLIP	
		Incoming	Outgoing
User	Automatic CLIP		✓
	CLIR		
	CLIR for redirecting		✓
	COLR		
	COLR for redirecting	3	
	Numbering plan NPI		
PISN users	Type of number TON		✓
	Number		✓
	CLIP selection (normal, user CLIP)	✓	✓

Configuration Element	Parameter	Affect on CLIP	
		Incoming	Outgoing
Trunk groups	Call NPI unknown	✓	
	Automatic CLIP		✓
	CLIR		✓
	CLIR for redirecting		✓
	COLR	3	
	COLR for redirecting	3	
	Numbering plan NPI		✓
	Type of number TON		✓
	Number		✓
	Truncate CLIP	✓	
	Send redirection/redirecting information	✓	✓
	ECT information		✓
	Transit CLIP format	✓	✓
	Transit exchange access prefix	✓	✓
	Send incoming CLIP for exchange-to-exchange connections	✓	✓
CLIP settings	International prefix	✓	
	Country code	✓	
	National prefix	✓	
	Long-distance code (national code)	✓	
	Display CLIR	✓	
Numbering plan	Own region prefix	✓	✓

4.6.1 User

Call to the Public Network

Call to the public network with exchange access prefix via a trunk group with *Network type = public*:

If *Automatic CLIP = yes*, the DDI number will be used as CLIP if the user is himself reachable by incoming calls via the path trunk group → direct dialling plan → CDE. If there is no direct dialling plan or corresponding DDI number, the CLIP number entered in the trunk group will be used instead.

The numbering plan and type of number are always taken from the trunk group.

If *Automatic CLIP = No* the configured number is used without any further changes.

Internal call to a PISN User

The creation of the CLIP number depends on the configured PISN user. If the PISN user has the setting *CLIP selection = Normal*, the DDI number is used as CLIP, providing the user is himself reachable by incoming calls via the path trunk group → Direct dialling plan → CDE.

If there is no direct dialling plan or corresponding DDI number (which is normally the case), the user's internal call number is used instead.

If the PISN user has the setting *CLIP selection = CLIP from user*, the CLIP number is created in the same way as for a call to the public network. This means that a permanently defined CLIP number can also be transmitted in the private network.

Internal call to an integrated mobile phone user

The creation of the CLIP depends on the configuration of the integrated mobile phone user:

- If *CLIP selection = Normal* is configured for the user, the direct dialling number of the calling user is used as the CLIP, regardless of his settings. If there is no corresponding direct dialling number, the internal call number is used in its place.
- If the user has the setting *CLIP selection = CLIP from user*, the CLIP number is created in the same way as for a call to the public network. In this case the calling user's settings are decisive (*CLIP automatic = Yes/No*).

Call with Route Selection via Trunk Group with *Network Type = Private*

By analogy with the call to a PISN user with the setting *CLIP selection = normal*.

4.6.2 PISN users

Number setting

The call number entered under *Number* is compared with the CLIP number of an incoming call. If the two numbers match up, the PISN user number is displayed as the CLIP with *NPI = private* and *TON = level 0*.

CLIP selection setting

See "[Internal call to a PISN User](#)", page 86.

4.6.3 Trunk groups

Call if NPI unknown setting

If a call with *NPI = unknown* is received, it is signalled with the internal or external ringing pattern on the basis of this setting. It is also decided at the same time whether the exchange access prefix (0-) should precede the CLIP number.

Truncate CLIP setting

A digit sequence can be configured here. If the sequence matches the initial digits of the CLIP number received, the digits will be truncated. This setting is normally used to remove any superfluous "0".

CLIP automatic setting

This setting is effective only if *Network type = private* has been set in the trunk group configuration.

If *CLIP automatic = yes*, the numbering plan identifier and type of number are left unchanged.

If *CLIP automatic = No*, the numbering plan identifier and type of number are taken from the trunk group setting, but not the actual CLIP number. This may be necessary in cases where connected third-party systems do not process numbering plan identifiers and types of number correctly.

Numbering Plan identifier, Type of Number, Number

These settings are used if the CLIP number could not be created automatically. This is the case when there is no suitable DDI number available with a call to the public network.

ECT information

If the parameter *ECT information = Yes* the new *CLIP* is also transmitted in the event of a call transfer to the exchange, provided the network interface involved is in the same trunk group.

Example:

Internal user A calls internal user B, who transfers to external user C. After the call transfer, C is presented with A's new *CLIP* instead of B's old *CLIP*.

The same applies accordingly with *COLP*, if the caller is an external user.

Example:

External user A calls internal user B, who transfers to internal user C. After the call transfer, A is presented with C's new *COLP* instead of B's old *COLP*.



Note:

With some carriers there are problems in connection with ECT information. Transmission of this information can therefore be suppressed using *ECT information = No* for each trunk group.

4.6.4 CLIP/CLIR settings

These settings are used to truncate prefixed access digits so that the CLIP number is as short as possible.

To enable the communication server to interpret CLIP numbers correctly, the system's own regional prefixes need to be entered under *CLIP/CLIR*:

- International and national prefixes for the locations ("00" and "0" for Switzerland, "00" and "-" for France)
- Country code and toll area code of the location (for Switzerland "41", for Geneva "22", see also "[Numbering Plan Identifier E.164](#)", page 44).



Aastra Intelligent Net:

In an AIN the nodes may be spread over different regions or even countries. Some settings do not apply throughout the system but only to one AIN region. An AIN region is assigned to one or more AIN nodes. An AIN region can also be assigned for each trunk group. The trunk group allocation takes priority over the node-specific allocation.

Display CLIR

When CLIR is activated (suppress CLIP) the public network provider will still send a CLIP to special customers, for instance the fire brigade and the police. The CLIR information will, however, include the CLIP (see also "[Suppressing CLIP / COLP \(CLIR / COLR\)](#)", page 77).

In the private leased-line network a CLIP is always sent with an activated CLIR. It is also provided with the CLIR information.

If *Display CLIR = yes*, a CLIP with CLIR information is still displayed in the case of incoming calls.

In internal traffic, a suppressed CLIP is always displayed.

4.6.5 Numbering plan

The CLIP number is prefixed with the regional prefix for outgoing calls to a PISN user or via a trunk group with *Network type = private*.

For incoming calls, the regional prefix is removed from the CLIP number (provided it begins with that digit sequence).

4.7 Examples of CLIP Displays in the PISN

Various scenarios are used in a sample network to illustrate how CLIP displays are handled in a PISN. [Fig. 35](#) shows the sample network.

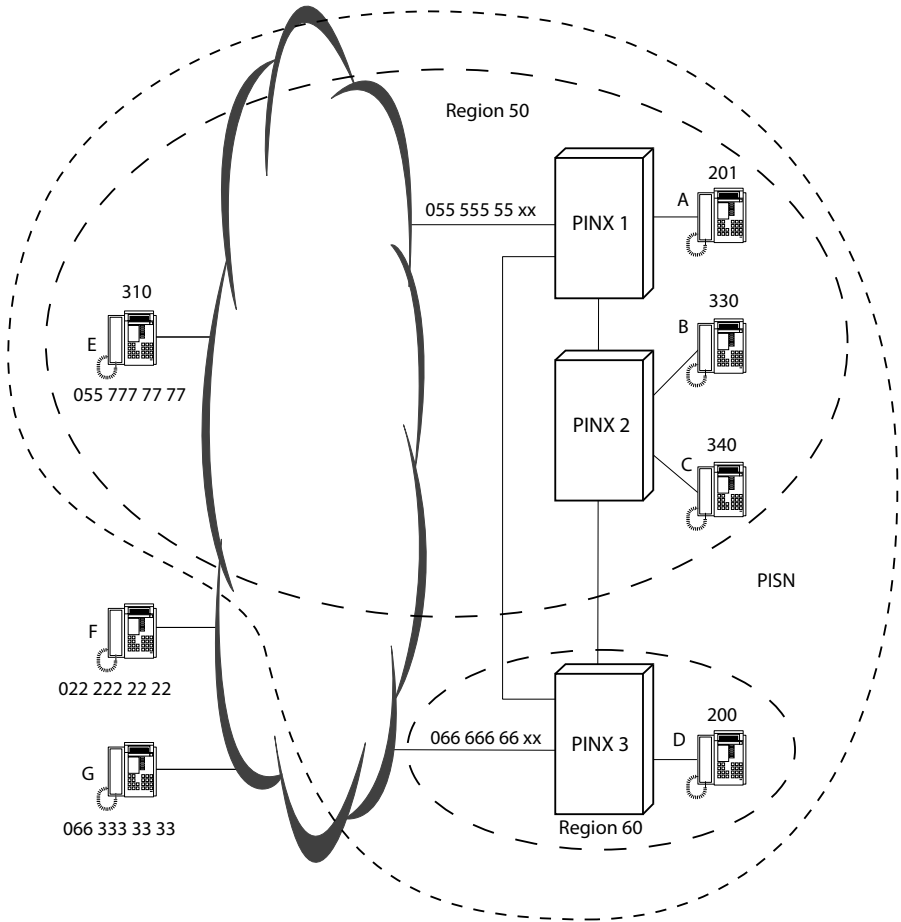

Fig. 35 Sample network: PISN with two regions and one virtual network user

4.7.1 PISN-Internal Calls

Ordinary PISN-Internal Call

User C (340) on PINX 2 calls user A on PINX 1 by a direct route. Both users belong to the same region.

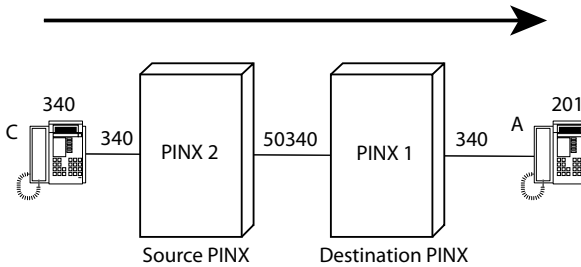

Fig. 36 Example 1: User C calls user A (excerpt from Fig. 35)

Tab. 25 Example 1: Creating and presenting user C's CLIP number

Step	CLIP number	NPI	TON	Description
1	340	PNP	level 0	User C → PINX 2 • There is no suitable DDI number.
2	50340	PNP	level 1	PINX 2 → PINX 1
3	340	PNP	level 0	PINX 1 • The system's own regional prefix is deleted • TON is adapted.
4	340			PINX 1 → User A • Presentation on the system phone

PISN - Internal Call with Overflow Routing

User C (340) on PINX 2 calls user A on PINX 1 via PINX 3 as all the available communication channels between PINX 2 and PINX 1 are busy. PINX 3 belongs to Region 60.

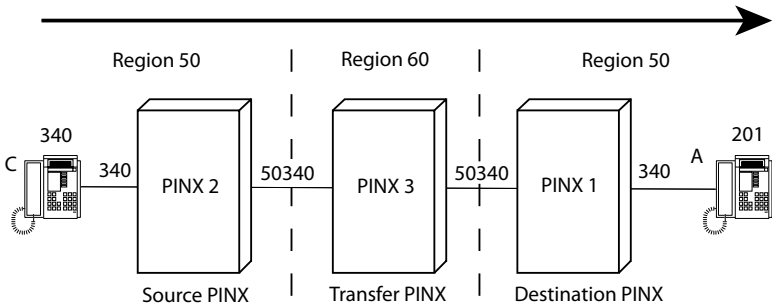

Fig. 37 Example 2: User C calls user A, overflow routing (excerpt from Fig. 35)

Tab. 26 Example 2: Creating and presenting user C's CLIP number

Step	CLIP number	NPI	TON	Description
1	340	PNP	level 0	User C → PINX 2 • There is no suitable DDI number.
2	50340	PNP	level 1	PINX 2 → PINX 3
3	50340	PNP	level 1	PINX 3 • There is no suitable DDI number.
4	50340	PNP	level 1	PINX 3 → PINX 1
5	340	PNP	level 0	PINX 1 • The system's own regional prefix is deleted • TON is adapted.
6	340			PINX 1 → User A • Presentation on the system phone

4.7.2 Outgoing Calls to the Public Network

Call to the Public Network via a Gateway PINX

User C (340) on PINX 2 calls user F on the public network via PINX 1. PINX 1 has a DDI number for user C (54).

The following CLIP characteristics are set in the trunk group configuration of PINX 1:

- *CLIP number* = 50
- *NPI* = *unknown*
- *TON* = *unknown*

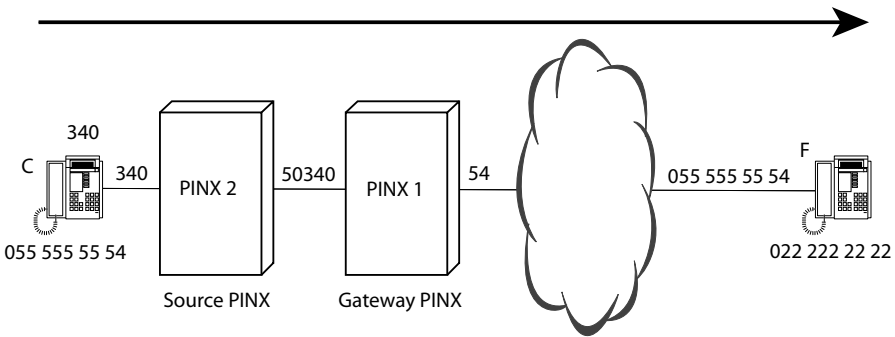

Fig. 38 Example 3: User C calls user F in the public network (excerpt from Fig. 35)

Tab. 27 Example 3: Creating and presenting user C's CLIP number

Step	CLIP number	NPI	TON	Description
1	340	PNP	level 0	User C → PINX 2 • There is no suitable DDI number.
2	50340	PNP	level 1	PINX 2 → PINX 1
3	340	PNP	level 0	PINX 1 • The system's own regional prefix is deleted • TON is adapted.
4	54	Unknown	Unknown	PINX 1 → Exchange • There is a suitable DDI number, which is used as a CLIP No. and sent to the public network.
5	055 555 55 54			Exchange → User F • Presentation on the terminal

Call to the Public Network via a Gateway PINX with Overflow Routing

User C (340) on PINX 2 calls user F on the public network via PINX 3 as all the available communication channels between PINX 2 and PINX 1 are busy. PINX 3 does not have a DDI number for user C.

The following CLIP characteristics are set in the trunk group configuration of PINX 3:

- *CLIP number* = 60
- *NPI* = *unknown*
- *TON* = *unknown*

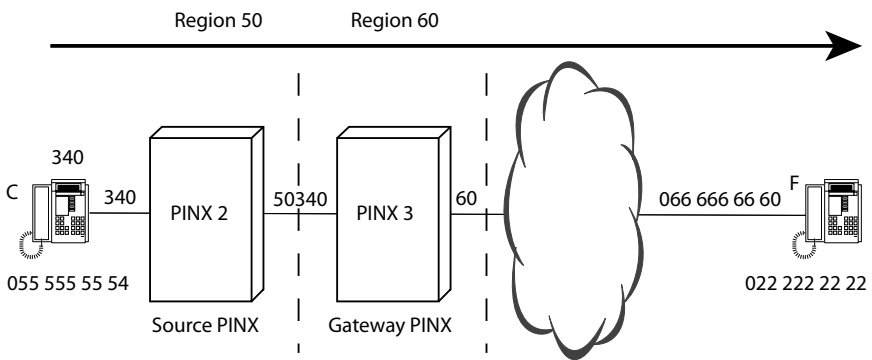

Fig. 39 Example 4: User C calls user F via an alternative path (excerpt from Fig. 35)

Tab. 28 Example 4: Creating and presenting user C's CLIP number

Step	CLIP number	NPI	TON	Description
1	340	PNP	level 0	User C → PINX 2 • There is no suitable DDI number.
2	50340	PNP	level 1	PINX 2 → PINX 3
3	50340	PNP	level 1	PINX 3 • There is no suitable DDI number.
4	60	Unknown	Unknown	PINX 3 → Exchange • The CLIP number entered in the trunk group configuration is sent to the public network.
5	066 666 66 60			Exchange → User F • Presentation on the terminal

Call to the Public Network via a Gateway PINX with Overflow Routing and **Automatic CLIP = no**

User B (330) on PINX 2 calls user F on the public network via PINX 3 as all the available communication channels between PINX 2 and PINX 1 are busy.

PINX 3 does not have a DDI number for user B.

Automatic CLIP = no is set in the user configuration of user B. The CLIP settings of the user configuration are used:

- **CLIP number** = 55 555 55 53
- **NPI** = E.164
- **TON** = national

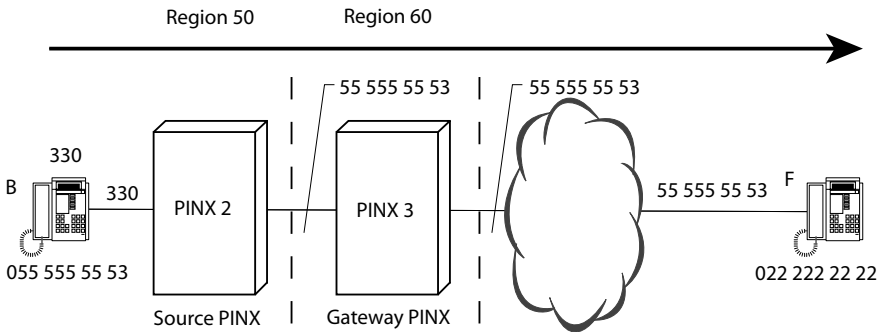

Fig. 40 Example 5: User B calls user F (excerpt from Fig. 35)

Tab. 29 Example 5: Creating and presenting user B's CLIP number

Step	CLIP number	NPI	TON	Description
1	330	PNP	level 0	User B → PINX 2 • A suitable DDI number is not searched for.
2	55 555 55 53	E.164	National	PINX 2 → PINX 3
3	55 555 55 53	E.164	National	PINX 3 • CLIP No. is buffered unchanged • A suitable DDI number is not searched for.
4	55 555 55 53	E.164	National	PINX 3 → Exchange • CLIP No. is sent unchanged to the public network.
5a	055 555 55 53			Exchange → User F • Presentation on the terminal if special arrangement is available (see page 71).
5b	066 666 66 60			Exchange → User F • Presentation on the terminal if special arrangement is not available (see page 71).

4. 7. 3 Incoming calls from the public network

User G on the public network calls user C on PINX 2 via PINX 1. He dials 055 555 55 54.

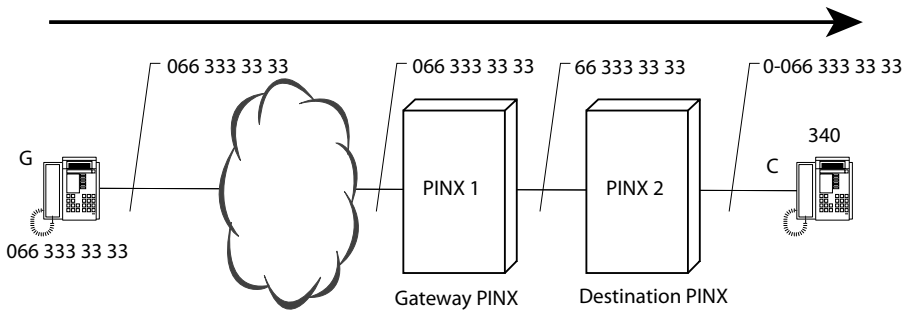

Fig. 41 Example 6: User G calls user C (excerpt from Fig. 35)

Tab. 30 Example 6: Creating and presenting user G’s CLIP number

Step	CLIP number	NPI	TON	Description
1	066 333 33 33	E.164	Unknown	User G → Exchange → PINX 1
2	66 333 33 33	E.164	National	PINX 1 <ul style="list-style-type: none"> • Prefix is truncated • TON is set to <i>national</i>.
3	66 333 33 33	E.164	National	PINX 1 → PINX 2
4	66 333 33 33	E.164	National	PINX 2 <ul style="list-style-type: none"> • CLIP number is not altered.
5	0-066 333 33 33 ¹⁾			PINX 2 → User C <ul style="list-style-type: none"> • Presentation on the system phone

¹⁾ In PINX 3’s trunk group configuration 066 666 60 is entered as the master number.

Call from the Public Network with Overflow Routing

User G on the public network calls user C on PINX 2 via PINX 1 and PINX 3 as all the available communication channels between PINX 2 and PINX 1 are busy. He dials 055 555 55 54.

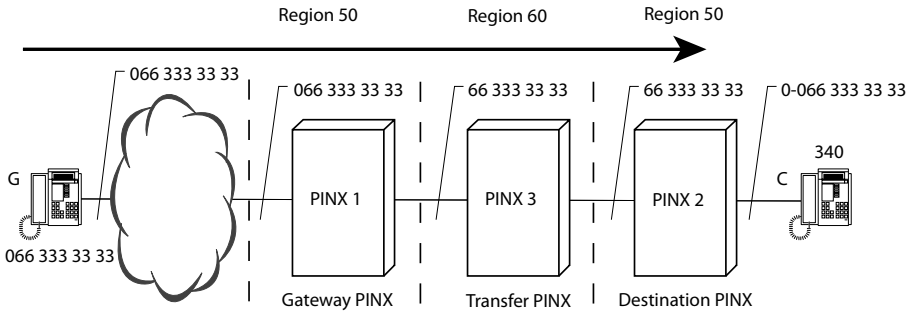

Fig. 42 Example 7: User G calls user C via PINX 3 (excerpt from Fig. 35)

Tab. 31 Example 7: Creating and presenting user C's CLIP number

Step	CLIP number	NPI	TON	Description
1	066 333 33 33	E.164	Unknown	User G → Exchange → PINX 1
2	66 333 33 33	E.164	National	PINX 1 • Prefix is truncated • TON is set to <i>national</i>
3	66 333 33 33	E.164	National	PINX 1 → PINX 3
4	333 33 33	E.164	Subscriber	PINX 3 • Long-distance code is truncated as it is the same as the system's own long-distance code • TON is set to <i>subscriber</i>
5	66 333 33 33	E.164	National	PINX 3 → PINX 2
6	66 333 33 33	E.164	National	PINX 2 • CLIP number is not altered.
7	0-066 333 33 33			PINX 2 → User C • Presentation on the system phone

Call made by a PISN user in the public network

PISN user E (310) on the public network calls user C on PINX 2 via PINX 1. He dials 055 555 55 54.

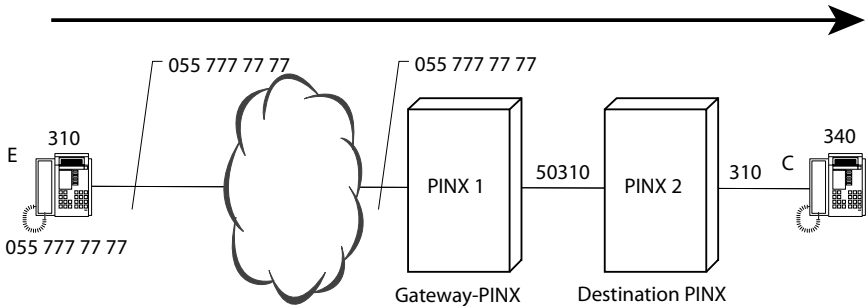

Fig. 43 Example 8: User E calls user C (excerpt from Fig. 35)

Tab. 32 Example 8: Creating and presenting user E's CLIP number

Step	CLIP number	NPI	TON	Description
1	055 777 77 77	E.164	Unknown	User E → Exchange → PINX 1
2	55 777 77 77	E.164	National	PINX 1 <ul style="list-style-type: none"> Prefix is truncated. TON is set to <i>national</i>.
3	777 77 77	E.164	Subscriber	<ul style="list-style-type: none"> Long-distance code is truncated as it is the same as the system's own long-distance code. TON is set to <i>subscriber</i>.
4	310	PNP	level 0	<ul style="list-style-type: none"> CLIP number matches the call number to PISN users: PISN user number is set A suitable DDI number is not found.
5	50310	PNP	level 1	PINX 1 → PINX 2 <ul style="list-style-type: none"> Regional prefix is added and TON is adapted.
6	310	PNP	level 0	PINX 2 <ul style="list-style-type: none"> System's own regional prefix is deleted and TON adapted.
7	310	Unknown	level 0	PINX 2 → User C <ul style="list-style-type: none"> Presentation on the system phone

4.7.4 CLIP format for transit connections in networks

Different CLIP formats are sometimes used in a PISN with PINX in different countries, with QSIG connection of third-party systems or applications, and with connections via an SIP network.

The CLIP format and an exchange access prefix can be configured to ensure that the correct CLIP is displayed in networks whenever possible, even with international transit connections.

Value range for the parameter *Transit CLIP format* in the trunk group settings (CM_2_1_3):

- *National:*
 - The CLIP for transit connections with incoming national calls is formed in accordance with *E.164/national*.
 - The CLIP for transit connections with incoming international calls is formed in accordance with *E.164/international*.
- *International:*

The CLIP for transit connections is formed in general in accordance with *E.164/international*.
- *Unknown with national prefix:*
 - The CLIP for transit connections with incoming national calls is formed in accordance with *E.164/unknown + National prefix + Transit exchange access prefix*.
 - The CLIP for transit connections with incoming international calls is formed in accordance with *E.164/unknown + International prefix + Transit exchange access prefix*.
- *Unknown with international prefix:*

The CLIP for transit connections is formed in general in accordance with *E.164/unknown + International prefix + Transit exchange access prefix*.

The parameter *Transit exchange access prefix* is also located in the trunk group settings and is configurable only if *Transit CLIP format* is set on *Unknown with national prefix* or *Unknown with international prefix*.

The parameters *National prefix* and *International prefix* can be found in the basic settings (CM_1_2_3) under *Own regional prefixes*.

4.8 CLIP on analogue exchange accesses

The systems are capable of receiving the number of incoming calls on analogue exchange accesses and forwarding it to terminals. This requires a number of settings to be made in AMS. The network provider must also support CLIP on analogue exchange accesses in accordance with ETSI standard (ETS 300 778-1).

The standard defines 4 different methods. The CLIP data is transmitted either before or during the call.

Data transmission before the call

Data transmission before the first ring. An alerting signal is sent beforehand. The alerting signal is either:

- a short ring (ring pulse)
- two successive tones (dual tone)
- A line polarity reversal followed by a dual tone.

Data transmission during the call

Data transmission between the first and the second ring. No special alerting signal is sent (the first ring is used as the alerting signal).

System configuration

Carry out the following settings under 2_2_1 in the Configuration Manager:

- *CLIP detection* = *Yes*
- *CLIP data attenuation*: The level of CLIP data varies from one network provider to the next. An excessively high level can lead to detection problems. Activating this parameter can attenuate the signal.
- *Alerting signal type*: The system supports data transmission during the call (setting *No alerting signal*) and both methods during data transmission before the call with the settings *Ring pulse* and *Polarity reversal & dual tone*. The setting required depends on the network provider.

5 Routing elements

The purpose of a routing element is to distribute incoming and outgoing calls to their destinations. This Chapter features all the elements involved in call routing. The settings allocated to a routing element are carried out in the system configuration. The multitude of setting options does, however, involve a considerable amount of configuration. That is why the default configuration has been selected in such a way that many settings no longer have to be adapted when configuring a stand-alone communication server.

5.1 Overview

From the system's viewpoint a destination is an interface (e.g. network interface or terminal interface). In this context user groups or user configurations are also routing elements, not destinations. [Fig. 44](#) shows how all the routing elements relate to one another:

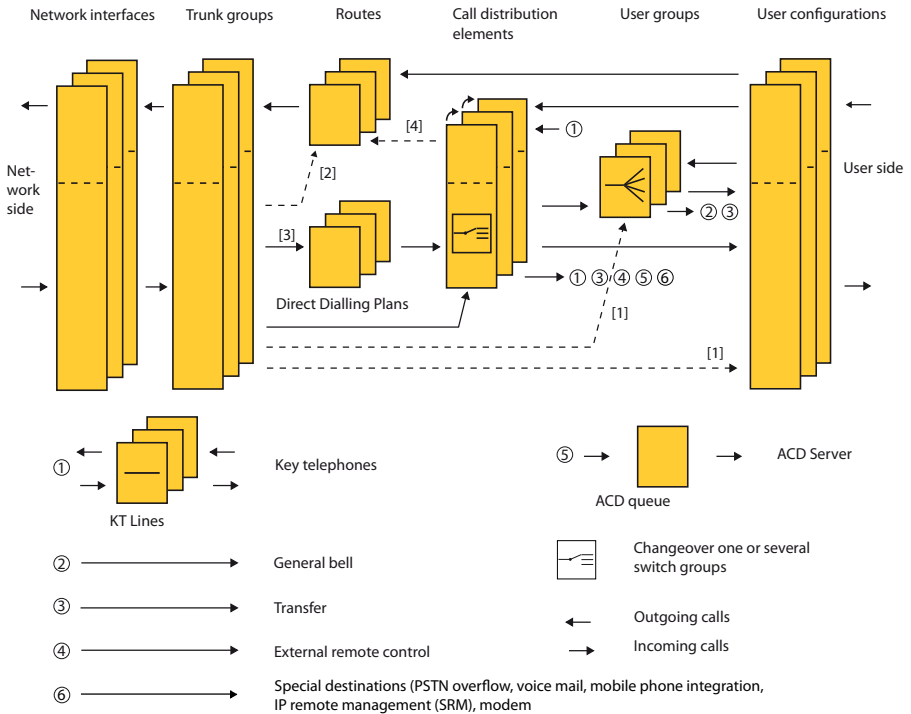

- [1] Routing via the numbering plan to one of the elements. Applies only to calls from the permanent network PISN (page 174)
- [2] Routing via a transit route (page 241) or as [1]. Applies only to calls from the permanent network PISN
- [3] Does not apply to calls from the analogue network
- [4] Outgoing KT calls

Fig. 44 How calls are routed in the system

Network interfaces

Network interfaces provide the access to the communication server from the outside. The settings for the network interfaces are used to specify network-specific characteristics (e.g. point-to-point or point-to-multipoint connection or the distribution of B channel groups at the primary rate access).

As network interfaces are not routing elements per se, they are not discussed further in this chapter.

Trunk groups

Network interfaces with the same characteristics are grouped together in a trunk group. For each trunk group, for example, it is specified whether the grouped network interfaces are connected to a private network or the public network (see [page 106](#)).

Direct Dialling Plans

Direct dialling is used to reach internal users or PISN users directly from the public network. The direct dial portion of an incoming call number is used to link the call with a specific call distribution element (see [page 118](#)).

Routes

All outgoing calls are routed to a trunk group via a route. They also include calls routed via the Least Cost Routing function and transit calls in a PISN (see [page 113](#)).

Call Distribution Elements

Call distribution elements are used to route a call to a destination or combination of destinations. The destination (or combination of destinations) can vary depending on the allocated switch position. If the original destination is busy or does not answer after a certain time, calls can be routed to alternative destinations (see [page 121](#)).

Switch Groups

Certain destinations and functions are selected depending on the switching position of a switch group. Each switch group has three switch positions, which are used for example for Day, Night and Weekend (see [page 129](#)).

User groups

In a user group incoming and internal calls are routed to a group of internal destinations in accordance with a pre-configured call distribution pattern (see [page 132](#)).

User configuration

All the user-specific settings are grouped together in the user configuration. This chapter deals exclusively with settings that are specific to routing and identification (see [page 143](#)).

Operator console

The system has one switching centre, which is defined under the name *Operator console* in the internal numbering plan. Several operator consoles can be operated in parallel (see [page 145](#)).

General Bell

Calls with the general bell as destination can be signalled via an external supplement (see [page 150](#)).

Key Telephones

Many of the system phones can be operated as key telephones with line keys. The line keys are linked to a call distribution element via *KT lines* (see [page 150](#)).

ACD Server

With an ACD application on the third-party CTI interface (ACD server), routing control can be shifted from the communication server to the ACD server (see [page 160](#)).



See also:

The interplay between the routing elements is described in the Chapter "Call routing", [page 163](#).

5.2 Trunk groups

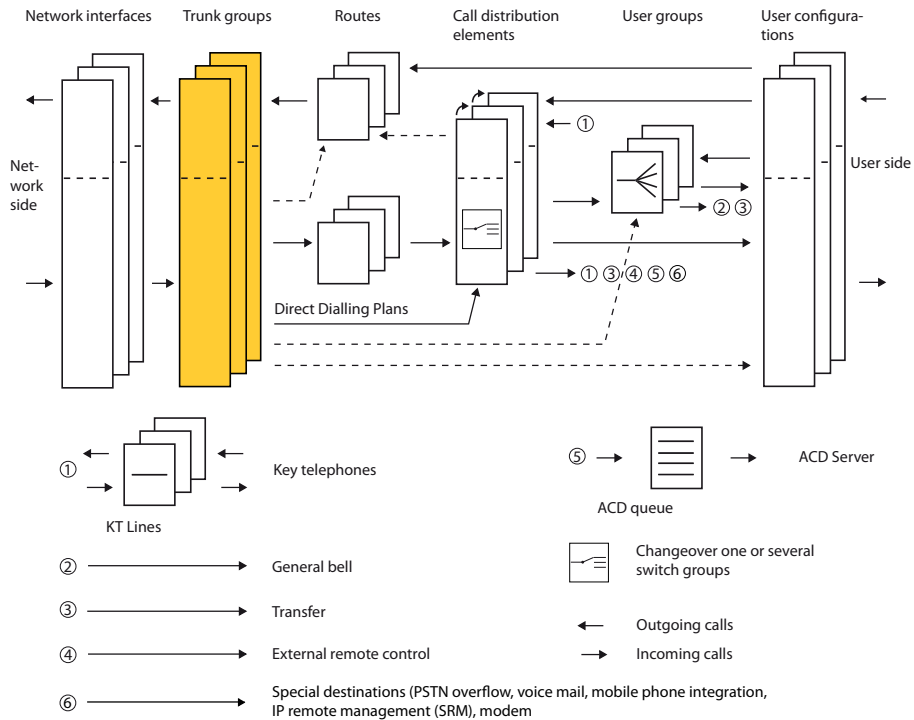

Fig. 45 Trunk groups in relation to the other routing elements

Network interfaces with the same characteristics are grouped together in a trunk group. For example, it is specified whether the network interfaces allocated to a trunk group are connected to a private network or the public network.

The trunk group is the key element for call traffic with the network. The trunk group configuration is allocated important routing and identification functions, essentially for incoming traffic. A number of settings are used for setting up special network configurations, for instance the optimum integration of PINXs by third-party manufacturers. The default values of these settings are such that they do not need to be adapted any further for conventional configurations.

5.2.1 Trunk Groups of Network Interfaces

General Rules and Settings

A network interface can only be assigned to a single trunk group.

A trunk group contains either analogue or digital network interfaces (the network interface entered first is decisive).

The digital network interfaces of a trunk group lead either

- to the permanently networked PISN if *Network type = private* is set,
- to the public network if *Network type = public* is set.

The following rules apply to the setting of the transmission protocol (*Protocol*) for the network interfaces of a trunk group:

- Trunk groups with *Network type = private* are usually set to the PSS1 (QSIG) protocol.
- Trunk groups with *Network type = public* are set to protocol DSS1.



Tip:

It is advisable to enter network interfaces that have the same destination in the same trunk group, for example to set up one trunk group for the public network, one trunk group for PINX 1 and one trunk group for PINX 2, etc.

Default settings

Newly set up digital network interfaces are automatically entered in trunk group 1.

Trunk group 1 is set to *Network type = public* and *Protocol = DSS1*.

Newly set up analogue network interfaces are automatically entered in trunk group 2.

Trunk group 2 is set to *Network type = public*.

Seizure Sequence for Outgoing Calls

Within a bundle the system will first try and seize the network interface that was entered last (large numbers). If for whatever reason this interface is not available, it will then attempt to seize the second last interface, then the third last, etc. (see also Fig. 48).

This is repeated for each outgoing call using the same principle. This means the call charges tend to accumulate on the network interface entered last.

BRI-S Interface as the Network Interface

An BRI-S interface set as *external* is also classified as a network interface and can be assigned to a trunk group.



Note:

If an BRI-S interface is reconfigured within a trunk group (to ETSI or V2), it is no longer a network interface and is removed from the trunk group.

B Channel Groups

The two user-information channels of a basic access and the 30 user information channels of a primary rate access can be divided into 2 and 4 B channel groups (*B channel list* setting¹⁾). This classification is carried out only if, for example, not all the B channels of the primary rate access are available. B channel groups can be separately allocated to a trunk group, for example the primary rate access on network interface 3.17 can be entered as follows:

- "3.17": All four B-channel groups are allocated to the trunk group.
- "3.17/2": Only B-channel group 2 is allocated to the trunk group.

Default: All B channels are in B-channel group 1.

Planning tips:

- B channels can only be grouped in sequence (e.g. channel group 1 contains B channels 1 to 6).
- A B channel can only be allocated to one channel group.
- If the B-channel groups of a primary rate access are spread among different trunk groups, the same protocol must be set for all trunk groups.

Configuration:

Once a trunk group contains a B-channel group, the trunk group's protocol can no longer be changed. For this reason it is important to proceed using the following configuration stages:

1. Enter the network interface of the basic or primary rate access in the first trunk group (e.g. "3.17").
2. Set the trunk group protocol (e.g. *DSS1*).

¹⁾ Dividing up B channel groups is not supported by all network providers.

3. Divide the B channels of the basic or primary rate access into B-channel groups. The network interface already entered is changed to B channel group 1 (entry changes to 3.17/1).
4. Enter the other B-channel groups in the required trunk groups. The protocol of the first trunk group is set automatically.

Line group in the ISDN

Digital outside lines that are to have the same traffic characteristics can be grouped into line groups in the public network (e.g. several basic accesses with the same DDI block).

A line group must also be recreated in the communication server. For this the network connections of the exchange lines of a line group must be allocated to the same trunk group (see [Fig. 46](#)).

A line group can consist of basic accesses, primary rate accesses or individual B-channel groups of primary rate accesses (also mixed).

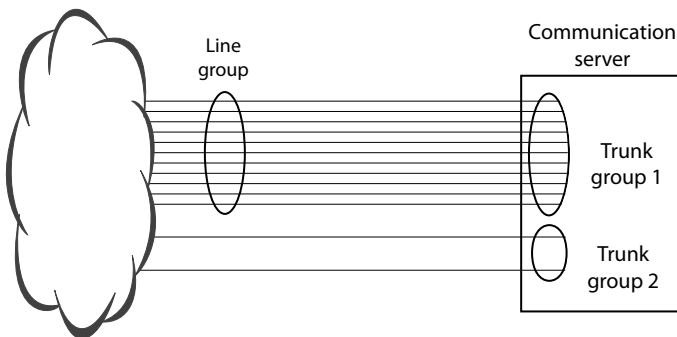

Fig. 46 Recreating a line group in the communication server

5. 2. 2 Routing Functions of the Trunk Group for Incoming Calls

The following incoming routing functions are assigned to the trunk group:

- Restricting the number of calls incoming simultaneously per trunk group
- Routing a call to one of the following elements:
 - Direct dialling plan (see [page 118](#))
 - Call distribution element (see [page 121](#))

- Destination of the internal numbering plan (see [page 174](#))
- Adapting the numbering plan identifier of an incoming call

Restricting the Number of Calls Incoming Simultaneously per Trunk Group

Once the set limit is reached (*Max. incoming calls* setting), no more calls are routed via the trunk group. This is signalled to the caller by means of the congestion tone. After an initialization the limit is set to approx. 80% of the available B channels.

5. 2. 3 Trunk Group Identification Functions

The CLIP numbers of outgoing calls can be influenced by the settings in the trunk group configuration. For more details see "[CLIP with Outgoing Calls](#)", [page 76](#) and following.

Truncate CLIP

See "[Trunk groups](#)", [page 88](#).

5. 2. 4 Other Trunk Group Functions and Settings

Name of the trunk group

Name is used to assign a name to each trunk group. The name's main purpose is to provide orientation. It is displayed on some system phones whenever an outgoing connection is set up.



Tip:

It is a good idea to name trunk groups according to the origin of their lines (e.g. "Public ISDN", "Analogue", "Leased Line Geneva", etc.). This ensures greater clarity during configuration work.

Generating a Ring-back Tone

With the settings *outgoing call, ring-back tone* and *incoming call, ring-back tone* the system is able to control, within certain limitations, the generation of the ring-back

tone on digital trunk connections. These settings do not have to be altered in normal operation.

- In the case of a stand-alone communication server on the public network the ring-back tone is supplied by the local exchange and does not have to be generated by the communication server.
- In a PISN with QSIG networking the ring-back tone always has to be generated in the destination PINX. In this case the setting *Incoming call, ring-back tone = Generate* is set permanently and cannot be altered.

Here are two applications in which the settings do have to be adapted:

- In a PISN with networking via DSS1 protocol the ring-back tone is normally also generated in the destination PINX (*Incoming call, ring-back tone = Generate*) There are however exceptions (e.g. communication server integrated in Centrex¹⁾) where the ring-back tone does not have to be generated internally. In such cases select the setting *Incoming call, ring-back tone = Do not generate*.
- It is possible that the destination does not generate a ring-back tone. (e.g. external IP gateways). In such cases it is possible to generate the ring-back tone locally. To do so, select the setting *Outgoing call, ring-back tone = Generate*.



Note:

If several PINXs are cascaded, generate the ring-back tone only once whenever possible and as close to the called user as possible.

Rerouting in the Exchange

The *Partial rerouting (PARE)* setting can be used to specify whether the system is authorized to place exchange-to-exchange connections to the exchange via the trunk group's exchange lines. If the exchange lines of two trunk groups are involved, this connection privilege must be granted to both trunk groups (see also "[Transferring Call Forwarding Unconditional to the Exchange](#)", page 231).

This setting is possible only for trunk groups with *Protocol = DSS1*.

Hold and Three-party Conference in the Exchange

For three-party conference in the exchange see "[Three-Party Connections in the Exchange](#)", page 234.

¹⁾ depends on the network provider

Truncate DDI setting

See "Direct Dialling Plan (DDI plan)", page 118.



Aastra Intelligent Net:

In an AIN the nodes may be spread over different regions or even countries. Some settings do not apply throughout the system but only to one AIN region. An AIN region is assigned to one or more AIN nodes. An AIN region can also be assigned for each trunk group. The trunk group allocation takes priority over the node-specific allocation.

The trunk group relevant settings for an AIN region are:

- CLIP / CLIR (prefixes and codes)
- Call logging (call charge information)
- Flash time vis-à-vis the exchange
- Pulse dialling times vis-à-vis the exchange
- Country (country-specific, non-configurable parameters such as ISDN protocol adaptations, line attenuations, etc.)

Allow 'Path Replacement' setting

Situation:

A call to an internal user is routed to an external application connected via QSIG. The application switches the call back to another internal user. If the parameter *Allow 'Path Replacement'* = Yes, the B channels used for the application are released again.



Note:

This functionality must not be confused with the QSIG path replacement as per ETS 300258 standardised in ETSI and can only be used in the interplay with the applications qualified or certified in A2P2 for this solution.



Other Trunk Group-related Subjects:

Network interfaces, Route, Incoming traffic, Outgoing traffic, Traffic in the PISN, Identification elements.

5.3 Route

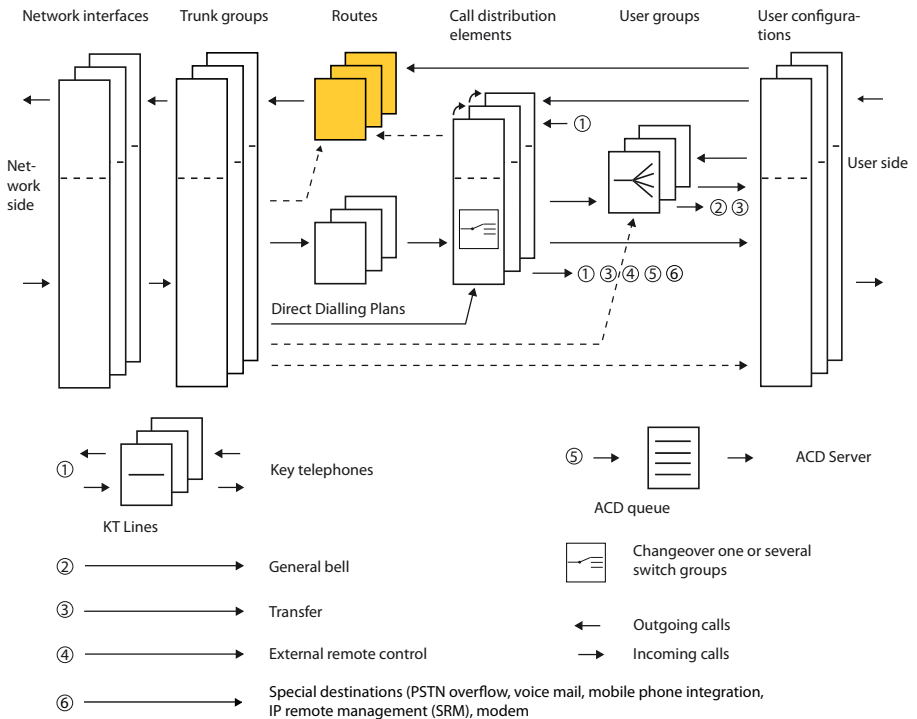

Fig. 47 Routes in relation to the other routing elements

The route function applies only to outgoing calls.

A route determines the direction of outgoing calls through allocation to trunk groups. All outgoing calls are routed via a route to one or more trunk groups. They also include calls routed via the Least Cost Routing function and transit calls in a PISN. Normally a separate route is set up for each PINX

The route elements can be allocated internal call numbers in the internal numbering plan. In this way a route element can be selected directly (route selection, see page 195).

Name is used to assign a name to each route. The main purpose of the name is to provide orientation; it does not have a routing function.

**Tip:**

It is advisable to name the routes according to their function. For example *Transit Routing*, *Remote Alarming*, *to PINX 3*, etc. It makes the configuration work all the clearer.

5.3.1 The Route's Routing Functions

The route is allocated the following outgoing routing functions:

- Routing an outgoing call to one or more trunk groups
- Restricting the number of calls outgoing simultaneously
- Polling an external digit barring
- Deleting the exchange access prefix
- Adding a prefix to the call number (where required)
- Specifying numbering plan identifier NPI
- Specifying how many digits need to be dialled before a call is set up

5.3.2 Routing an Outgoing Call to a Trunk Group

Up to 8 trunk groups can be entered for each route (*Trunk group* setting). Within a route the bundles are seized from front to back (small numbers first); within the bundle, the network interfaces from back to front (large numbers first). The seizure sequence is illustrated in Fig. 48

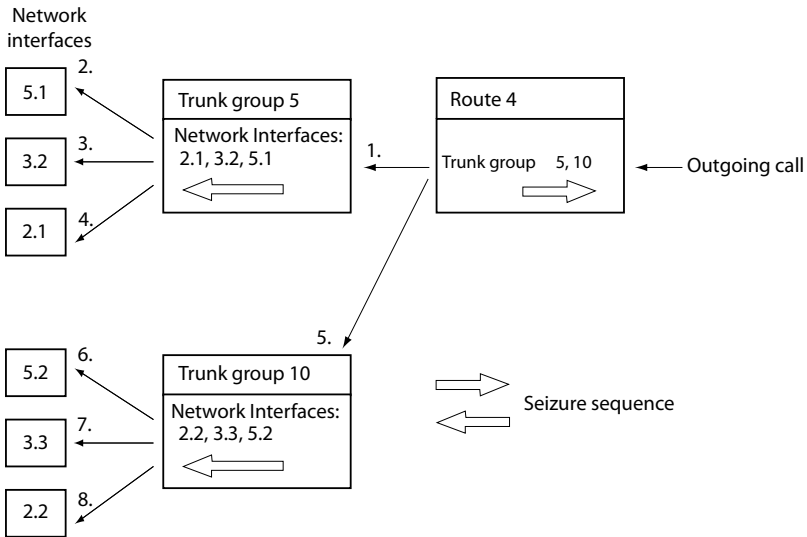

Fig. 48 Seizure sequence for network connections in the case of an outgoing call

If both analogue and digital network interfaces are being used, one trunk group has to be entered in each route for the analogue interfaces and one trunk group for the digital interfaces since a trunk group can only contain either analogue or digital interfaces.

Default settings

- After initialization, route 1 is allocated trunk groups 1 and 2.
- After initialization, route 3 is allocated trunk group 1 (route for remote alarming).
- With Aastra 415/430 all routes are allocated numbers from 170 upwards in the numbering plan.
- On the Aastra 470 system the first 24 routes are allocated numbers from 170 upwards in the numbering plan.



Aastra Intelligent Net:

In an AIN the local network interfaces of nodes can be prioritised for each route. (Setting CM_2_1_4, parameter *Use node network interfaces first*). This allows outgoing calls from DECT cordless phones to PISN users or integrated mobile phones to be routed primarily via the system's own network interfaces, thereby saving VoIP resources.

5.3.3 Other Routing Functions for Outgoing Calls

Restricting Calls Outgoing Simultaneously

The *Max. outgoing calls* setting is used to specify the number of outgoing calls that are possible simultaneously. Once the limit has been reached, users can no longer make outgoing calls with the allocation of this route. This is signalled by means of the congestion tone.

Activating / Deactivating External Digit Barring

Normally an outgoing call is compared with the external digit barring allocated in the user configuration.

The *External digit barring* setting is used to deactivate the external digit barring for each route. This is useful when a route is set up for calls into the private leased-line network.

Deleting the exchange access prefix

If the call number of an outgoing call has an exchange access prefix, it will be truncated before the call is forwarded.

Adding a Prefix to the Call Number

Send access code is used to define a prefix which is added to a call number (which no longer has an exchange access prefix).

The prefix can be used to transmit a call to the public network via a third-party PINX by specifying a route number as the exchange access prefix for the gateway PINX..

Specifying the Numbering Plan Identifier NPI and the Type of Number TON

The call number of an outgoing call is assigned the NPI defined under *Numbering plan identifier NPI*.

- For routes that are used for routing outgoing calls whose end destination is in the public network, set *E.164*.
- For routes that are used for routing outgoing calls via dedicated lines with end destination in the PISN, set *PNP*.

TON = unknown is always assigned as the type of number. This cannot be modified in AMS.

Send Delay

Send delay is used to specify how many digits need to be dialled before a call is set up. The dial tone will be supplied by the communication server as long as the line is not seized.

This setting is useful in the following situations:

- When calls are routed to the public network via third-party PINXs
- When the destination system can only evaluate whole call numbers (Overlap Receiving not supported)
- To save line resources under heavy traffic conditions



Other Subjects Related to Routes:

Trunk group, Call distribution, User configuration, Operator Consoles, key telephone, Outgoing traffic, Least Cost Routing, Traffic in the PISN, Numbering plan.

5.4 Direct Dialling Plan (DDI plan)

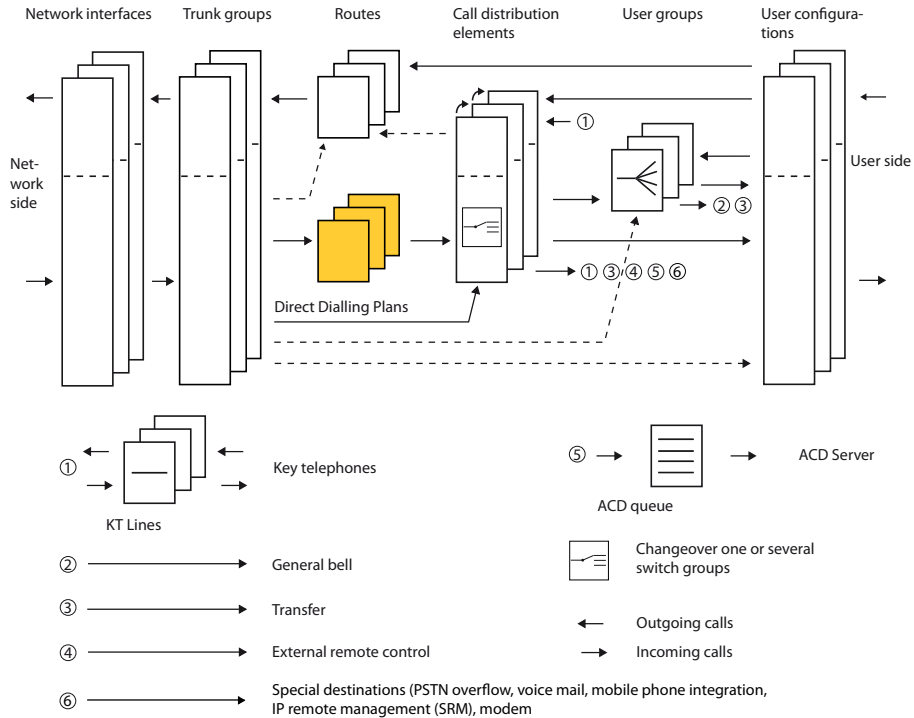

Fig. 49 Direct dialling plans in relation to the other routing elements

Direct dialling is used to reach internal users directly from the public network or from another PINX. The incoming call is linked with a call distribution element on the basis of the call number's direct dial portion.

Within a direct dialling plan, number ranges are created by agreement with the public network operator; these numbers match up with the anticipated direct dial portions of the call numbers. In a three-digit direct dialling plan, for example, number ranges of 300...399 and 500...549 are created.

Depending on the country in which the PBX is operated, the ISDN public exchange may send the complete call number or only a part of it. If the complete call number is sent, the digits that do not form part of the direct dialling number can be truncated starting from the left using the setting *Truncate DDI* in the trunk group configuration.

Several Direct Dialling Plans per communication server / PINX

Several direct dialling plans are available. This ensures that the same user can be reached from the outside via different network accesses and that the correct CLIP is also transmitted in outgoing traffic.

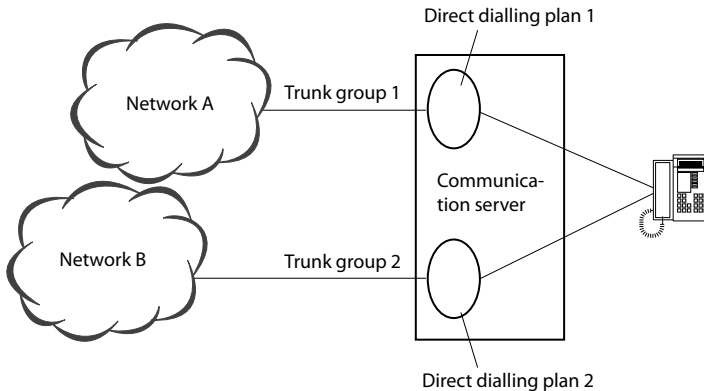

Fig. 50 Several Direct Dialling Plans per communication server / PINX



Tip:

Use a separate direct dialling plan for each individual network access to the public network (e.g. for different network providers, point-to-point / point-to-multipoint connections, different SLGs or different direct dialling ranges).

Direct Dialling Plans in the Private Leased-line Network

Direct dialling plans can also be used in the private leased-line network. This is the case in particular if incoming calls from the private leased-line network are to be routed depending on the switching position of a switch group (see [page 260](#)).

Linking a Direct Dial Number with a Call Distribution Element

Direct dial numbers are created as blocks with 1 to several numbers. When the number range is created each direct dial number is automatically linked with a call distribution element. A call distribution element can also be subsequently allocated to several numbers.

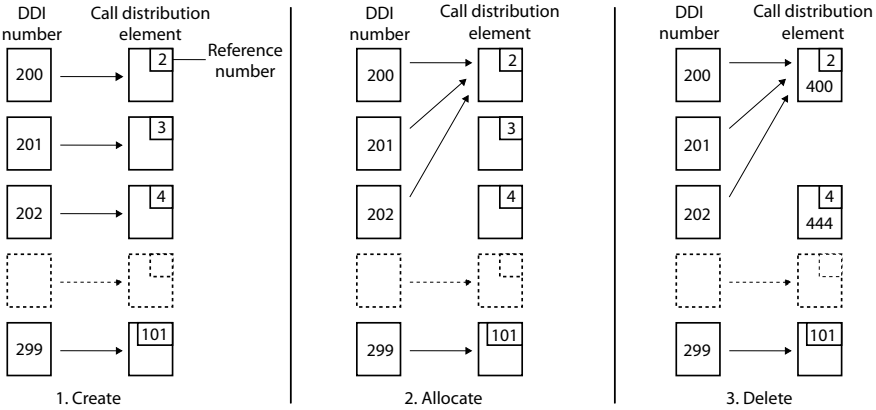

1. When direct dial numbers are created, call distribution elements are assigned automatically
2. Several direct dial numbers can be allocated to one call distribution element.
3. For performance reasons unused call distribution elements should be deleted.

Fig. 51 Linking direct dial numbers with call distribution elements

Destinations can be allocated to the linked call distribution elements as soon as they are created. Various options can be selected using the setting *Link matching users* (Tab. 33).

Tab. 33 Allocating CDE destinations using the setting *Link matching users*

Parameter value	Result
No	A common CDE destination can be allocated to all the DDI numbers of the new block, depending on the switching position of a switch group. Default: UG 16
yes, do not create non-matching	A DDI number will only be created if an internal user with the same number already exists. The user will be allocated as the CDE destination for all the switch positions of a switch group.
yes, create non-matching also	All the DDI numbers of the new block will be created. If internal users with the same numbers exist they will be allocated as call distribution destination. A common CDE destination can be allocated to all the other DDI numbers, depending on the switching position of a switch group. Default: UG 16

The system only provides direct dialling plans for digital network interfaces.



Other Subjects Related to Direct Dialling Plans:

Trunk group, Call distribution, Incoming traffic, Traffic in the PISN, Identification elements, Numbering plan

5.5 Call Distribution Element (CDE)

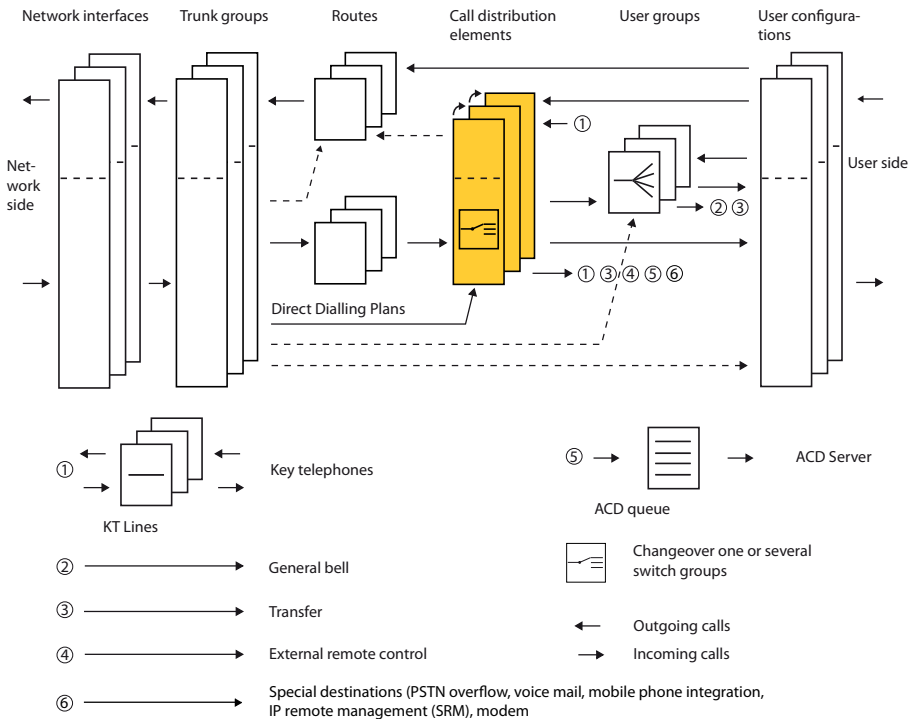

Fig. 52 Call distribution elements in relation to the other routing elements

Call distribution elements are used to route an incoming call to an individual destination or to a combination of destinations.

Each call distribution element is assigned a switch group. The destinations can be specified differently for all three switch positions of the switch group.

Each call distribution element can be linked with two other call distribution elements for the routing to alternative destinations if either the original destination is busy or the call is not answered.

A call distribution element can be addressed both internally and externally. It can route a call to an internal or an external destination.

Call distribution elements can be allocated call numbers in the numbering plan. Internal calls can then be routed to a call distribution element by selecting one of these numbers (but not with name selection).

Restrictions:

- Call forwarding unconditional and call forwarding on no reply cannot be applied to a call distribution element.
- The features Call waiting / Intrusion and automatic callback cannot be activated on call distribution elements
- A call distribution element cannot be stored under a team key.
- In addition a call distribution element cannot be part of a preconfigured conference or of a user group.
- A call distribution element cannot be called using name selection.



Tip:

To be able to dial a call distribution element using name selection, you can use an abbreviated dialling number with the stored call number of the call distribution element.

5.5.1 Call destination

With the destination information of a call distribution element an internal call or an external incoming call can be routed to individual destinations or combinations of destinations.

Individual Destinations

A call is routed is to one of the following destinations:

- Users (internal users, PISN users, integrated mobile phones, etc.)
- UG: User Group (see [page 132](#))
- KT: KT line (see [page 150](#))
- Operator console (see [page 145](#))
- ACD: ACD queue (see [page 160](#))
- ERC: External remote control (see [page 491](#))
- Special destinations:
 - PSTN overflow routing (see AIN System Manual "Astra Intelligent Net")
 - Voice mail (see [page 382](#))
 - Mobile phone integration (see [page 52](#))
 - Modem (see AMS Online Help)

Multiple destinations

Calls can be routed to the following multiple destinations

- User+UG
- User+KT
- UG+KT
- User+UG, busy
- User+KT, busy

If the first destination is busy with multiple destinations busy, the second is not called and the caller obtains the busy tone:

The destinations are defined for each of the three switch positions of the selected switch group (e.g. for Day, Night, Weekend). Other destinations can be defined for each switch position.

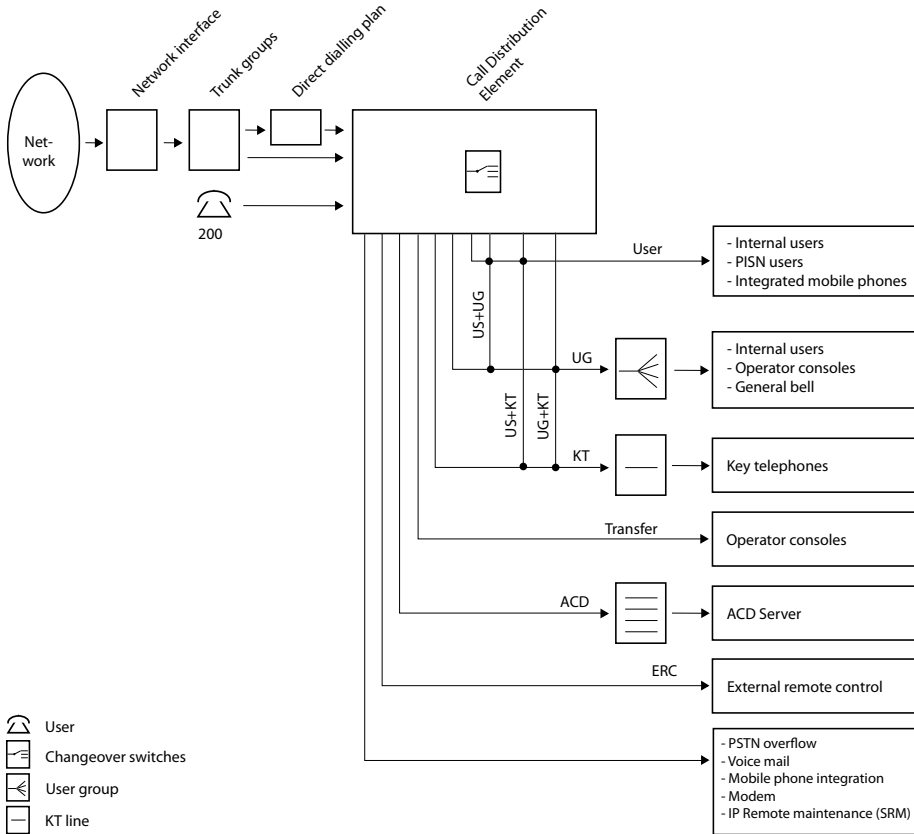

Fig. 53 Destinations of the call distribution element

Alternative Destinations

A call distribution element can be linked with two other call distribution elements for the routing to alternative destinations:

- One of the call distribution elements is used for the routing to alternative destinations if a call at the original destination is not answered.
- The other call distribution element is used for the routing to alternative destinations if the original destination is busy.

Alternative Destination if no Answer

If at the original destination the call is neither answered nor forwarded within a configurable period of time (*CDE forwarding time* setting), it is routed to the call distribution element entered under *CDE if no answer*. The original destination will then stop ringing

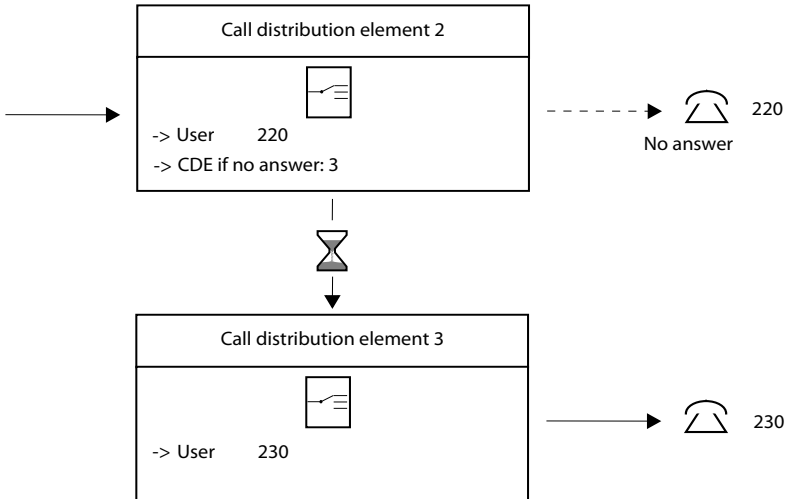

Fig. 54 Routing via CDE if no answer

If the call is not answered at the alternative destination either, it will be routed to another call distribution element if such an element has been entered under *CDE if no answer*.

If the alternative destination is busy, the call is not forwarded.

The CDE forwarding time can be set individually for each call distribution element.



Note:

If a call forwarding destination is defined under *Default CF if no answer* in the user configuration, the call will be redirected after the internal or external delay configured there (see "Default forwarding per user", page 176).

Announcement service

A previously activated welcome announcement by the announcement service will remain activated if the call is routed to the alternative destination. The welcome announcement is not reactivated at the next CDE.

Alternative Destination is Busy

If the original destination is busy, the call is routed to the call distribution element entered under *CDE if busy*. If the alternative destination is also busy, the call is routed to the next alternative destination -- if such a destination has been configured. This process can be repeated up to the fifth call distribution element. If the destination of the fifth call distribution element is also busy, the caller will obtain the busy tone.

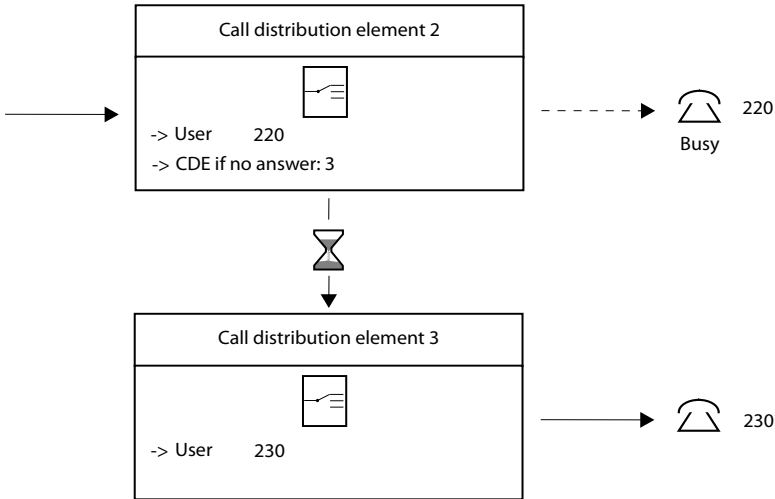

Fig. 55 Routing to an alternative destination if the original destination is busy



Note:

It makes no sense to use *CDE if busy* together with the destination combinations *User+UG, busy* and *User+KT, busy*.

Application Example of an Overflow

Implementing an overflow from a busy user group (e.g. Purchasing group) to another user group (e.g. Customer Service group).

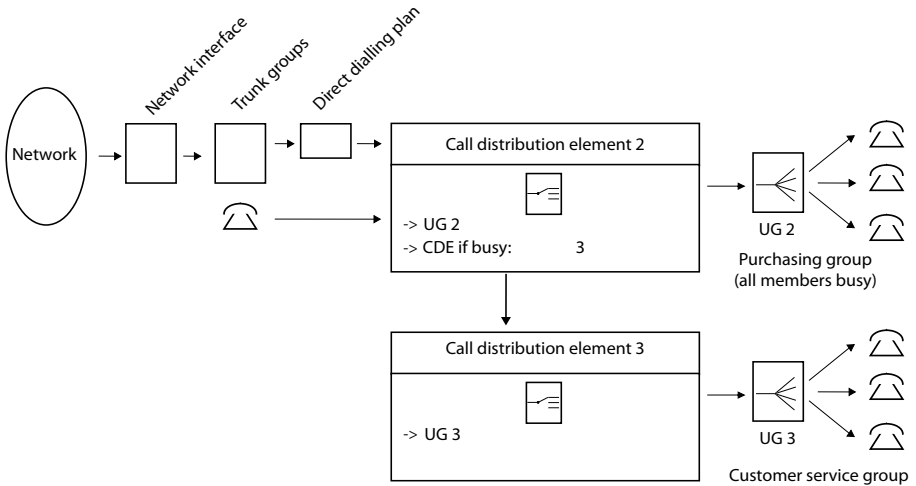

Fig. 56 Application example of the configuration of an alternative destination if busy



Aastra Intelligent Net:

If in an AIN a satellite user can no longer be reached due to a connection interruption or because of insufficient bandwidth between the Master and a satellite, and if no unobtainable destination has been defined for the user, the following happens:

- Incoming external callers via Master obtain the busy tone provided they are not rerouted to an obtainable destination due to an entry under *CDE if busy*.
- For internal callers who want to reach the user on the "lost" satellite, the system responds as if no terminal were connected, except if the user is also called via the CDE.

5. 5. 2 Routing Functions for Incoming Calls

Call distribution is allocated the following incoming routing functions:

- Routing a call to a destination, depending on the position of the allocated switch group (see "*Call destination*", page 122).
- Routing a call to an alternative destination if the original destination is either busy or if the call goes unanswered (see "*Alternative Destinations*", page 124).
- Restricting the number of calls incoming simultaneously on each call distribution element (*Incoming connections* setting) As soon as this limit is exceeded, any

subsequent caller will obtain busy, provided no alternative destination *CDE if busy* has been defined.

- Routing a call to data service destinations:
Data service destinations can be configured for each call distribution element (see "Data service", page 255).
- Routing a call to external remote control or modem:
This destination is normally allocated only once in every system to enable access to external remote control via a DDI number. (See "Remote controlling features from outside the system", page 491.)

5.5.3 Routing Functions for Outgoing Calls

Outgoing calls via the line keys of a key telephone are routed via the route entered under *KT route* (see "Key telephones", page 150).

5.5.4 Other Functions and Settings of the CDE

Name

Name is used to assign a name to each call distribution element. The name is used for identification purposes.

- With incoming calls it is displayed on the system phone.
- With outgoing calls via KT lines it is provided as CNIP.

The name cannot be used for dialling by name.

Displaying DDI

With incoming calls the direct dialling number can also be displayed instead of the name of the call distribution (*Force showing DDI number = Yes*). This is needed for CTI applications in particular.

Activating / Deactivating Incoming Call Logging (ICL)

Incoming call logging can be activated or deactivated for each call distribution element (see "Call logging for incoming calls (ICL)", page 280).

Specifying the Company Configuration

The *Company* setting specifies whether or not the call distribution element is to be used in a two-company configuration (see "Two-company system", page 147).

Announcement service

Each call distribution element can be assigned a welcome announcement or the function *Stop* or *Music* for each switch position (see "[Announcement service](#)", page 458).

KT Cost Centre

Call charges for calls via the KT lines of a call distribution element are logged at the cost centre entered under *KT cost centre* (see also "[Outgoing Calls via a KT Line](#)", page 156).



Other Subjects Relating to Call Distribution:

Trunk group, Direct dialling plan, User group, Key telephones, User configuration, Internal traffic, Incoming traffic, Outgoing traffic, Traffic in the PISN, Switch groups, Numbering plan.

5.6 Switch Groups

With the aid of the switch groups the routing configuration for the system can be conveniently adapted to the time and situation-related requirements of the customer. This means for example that calls during the day can be routed differently to calls at night, or differently at times with a high call volume to times with a low call volume (e.g. at radio stations or in telemarketing).

Certain destinations and functions are selected depending on the switching position of a switch group. Each switch group has three switching positions. The switch positions can be used for example for day, night and weekend. There are twenty switch groups. The switch groups have changeover switches for

- Routing incoming calls to internal destinations in a CDE.
- Routing incoming calls to a welcome announcement of the announcement service
- Routing outgoing emergency calls

Switch group 1 also has changeover switches for

- Allocating an external digit barring for each internal user
- Allocating an internal digit barring for each internal user
- Allocation of an internal destination for the door bell if another switch group is not assigned to the control input of the option card.

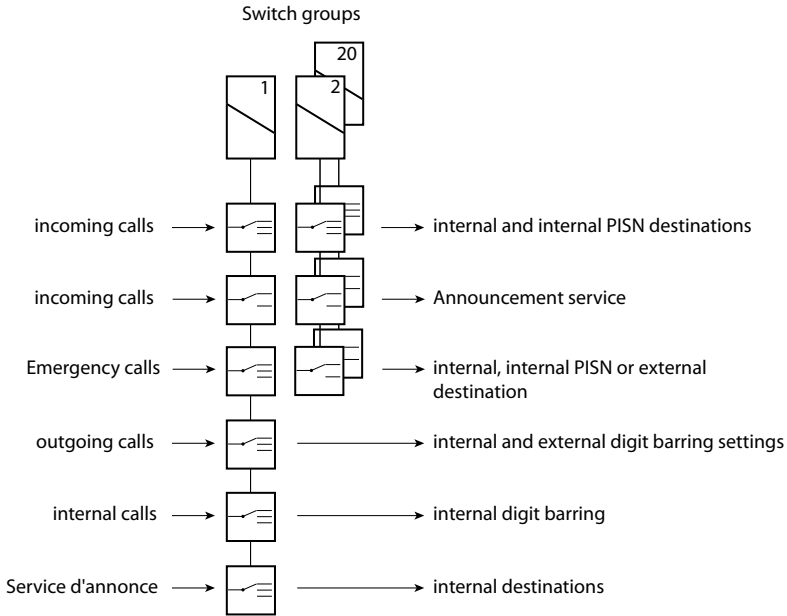

Fig. 57 Switch groups and how their changeover switches are used

The choice of switch group and the assignment of the switch positions are carried out in the appropriate menus of the system configuration. After initialization the changeover switches are allocated throughout to switch group 1.

Switch groups are selected via menu selection or by dialling `*/#` function codes on a terminal (see "[Switching switch groups](#)", page 476). The relevant authorization can be regulated individually for each internal user. (*Operate switch group* setting). Digit barrings can also be used to limit authorizations to individual switch groups.

The switch groups can also be switched over via FXS interfaces configured as control inputs or via the control inputs of an ODAB options card (Aastra 415/430). The switch group configuration determines which of the switch groups 1...20 are switched. Selection via the control inputs takes precedence over selection via `*/#` function codes. This means that the `*/#` function codes cannot be executed as long as a signal is imposed at the control inputs.



Aastra Intelligent Net:

In an AIN the control inputs can be used as a mix of FXS interfaces and ODAB options cards (Aastra 415/430). The maximum number of cards per communication server has to be taken into account. The switch group configuration determines which options card switches what switch group. The following rules apply:

- The card identification is determined by the node number and slot number.
- A card's control inputs can control one or more switch groups.
- The same switch group can only be switched by the control inputs of one card.

Application Example for Switch Groups

If the secretary is the last person to leave the office at 6.30 p.m., she activates the night service using the menu selection on the Office 45 or an external switch. The responses are then as follows:

- From this moment onwards external calls to the customer service number will be diverted to a telephone answering machine.
- Callers to the main numbers will be informed of the office hours using a welcome announcement of the announcement service.
- The DDI numbers of office workers will be routed to the voice mail service.
- While dialling out will not be permitted in principle, emergency numbers are enabled.

To achieve the above, the following allocations were made for switch position 2 (*Night*) of switch group 1 in the system configuration:

- All customer service DDI numbers are routed to the internal number of the telephone answering machine in the call distribution elements.
- In the call distribution element the main call number is assigned the prepared welcome announcement of the announcement service. (The welcome announcement must be activated.)
- All the office workers' direct dialling numbers are routed in the call distribution elements to UG 17 (Aastra 415/430) or UG 25 (Aastra 470) in which voice mail is located.

As the user-specific allocation of the digit barring also depends on the switching position of the switch group, they need to be adapted accordingly.



Other Subjects Related to Switching Groups:

Call distribution, User configuration, Operating switching groups

5.7 User Group

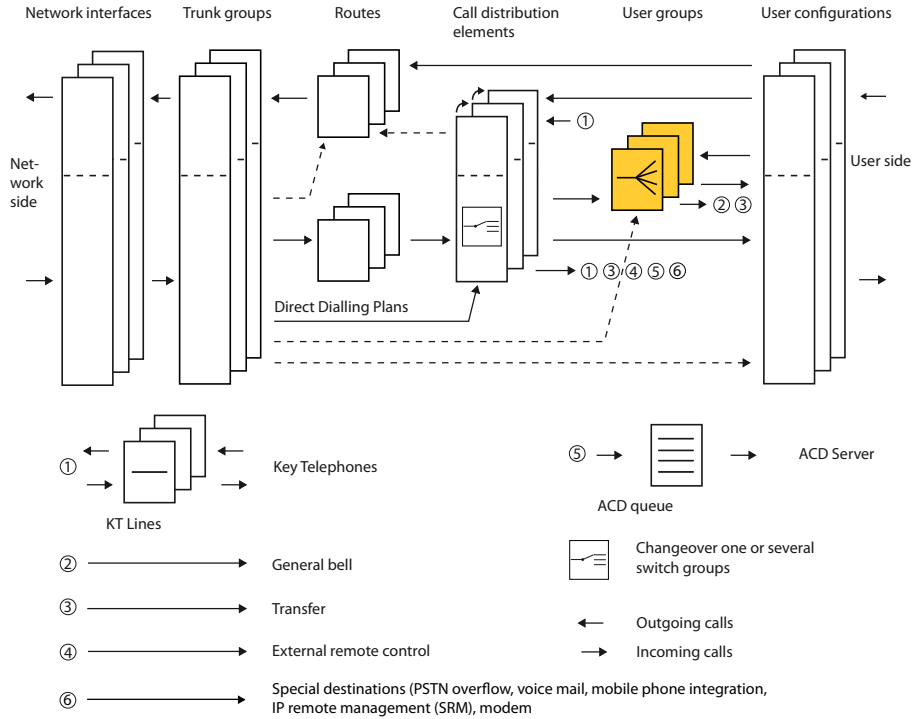

Fig. 58 User groups in relation to the other routing elements

In a user group incoming and internal calls are routed to a group of internal destinations in accordance with a pre-configured call distribution pattern.

Incoming Calls

User groups are selected by means of their call numbers or names (name selection). The call numbers of user groups are a separate category of the numbering plan.

CFU or CFNR cannot be made to a user group (except for user groups with special functions and user groups configured as "large").

Outgoing Calls

User groups do not affect outgoing routing.

User group types

There are three types of user groups:

- [Ordinary user groups](#)
- [Large user groups](#)
- [User Groups for Voice Mail and Other Applications](#)

5.7.1 Ordinary user groups

5.7.1.1 Elements of a User Group

A user group consists of one or more of the following elements:

- **Member group:**
Group with up to 16 internal users (members). Each user can be allocated several terminals (see ["One Number user concept"](#), page 337).
- **Operator console:**
The call is signalled in parallel on all operator consoles (see ["Operator console"](#), page 145).
- **General bell:**
Centralized acoustic signalling of a call (see ["Answer general bell"](#), page 456).

All the elements can be connected to each user group in the user group configuration (see [Tab. 34](#)).

Tab. 34 How user group elements are connected

Element	Added on by:
Member group	Entering at least one user as member of the group
Operator console	Connect [yes / no]
General Bell	Connect [yes / no]



Note:

If the element operator console or general bell is connected without an operator console or general bell actually being connected, calls to this destination will simply idle.

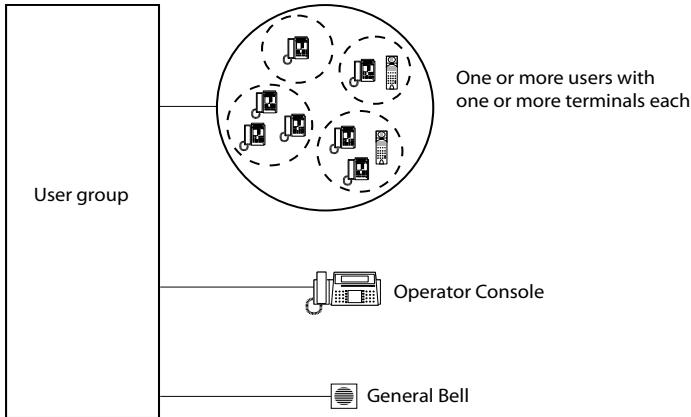

Fig. 59 Elements in a user group

Call Distribution to the Elements

A call is distributed in parallel to the connected elements of a user group. Each element can be individually delayed. The delay time can be set globally to 3, 5 or 7 ringing cycles and applies throughout the system to all line groups.

5. 7. 1. 2 Call distribution in the member group

There are three possibilities for call distribution to the members within member line group:

- *Global*
- *Linear*
- *Cyclic*

Global Call Distribution

In a global call distribution all the available members in the group are called simultaneously. As soon as any member answers the call, the call to the other members is cleared down.

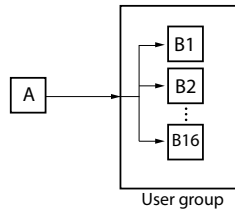

Fig. 60 Global Call Distribution

Linear Call Distribution

In a linear call distribution the first member in the group is called first. If he does not answer, the call is forwarded to the next member after 3, 5 or 7 ringing cycles. Linear call distribution bypasses busy members.

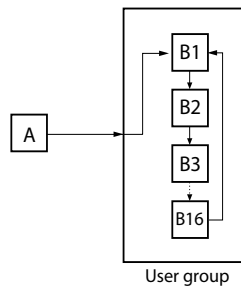

Fig. 61 Linear Call Distribution

Cyclic call distribution

Call distribution is the same as in the linear variant except that each new call is first signalled in each case to the next member in the row.

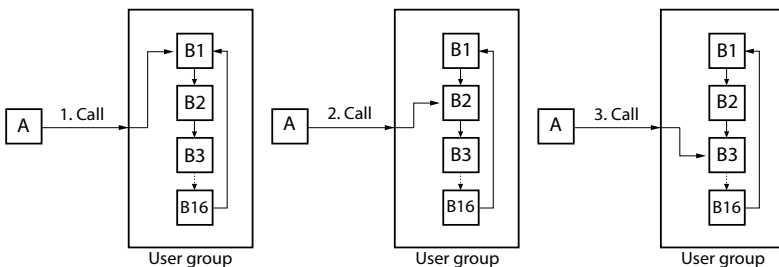

Fig. 62 Cyclic call distribution

Delayed Calls to Subgroups

The members of the member group element can also be subdivided into a main group and a subgroup (*UG subgroup as of member* setting).

The subgroup is called according to the set call distribution:

- If call distribution is set on *global*, the subgroup rings once the configured delay time has elapsed.
- If call distribution is set on *linear* or *cyclic*, the subgroup rings once the configured forwarding time has elapsed after the call has been ringing at the last member of the main group.

The members of the subgroup are always called according to the *global* call distribution.

In Summary

In a user group there are two selectable times that can be used for controlling call distribution. Both are preconfigured in the system configuration:

- The delay time affects
 - The user group elements. It can be activated and deactivated for each element.
 - The subgroup of members of the member group set on *global*.
- The forwarding time for *linear* and *cyclic* call distribution among the members of the member group.

The duration of the delay time and forwarding time can be set globally to 3, 5 or 7 ringing cycles.

Other delay times can also be specified on a user's terminal, e.g. the delayed signaling on a line key of a key telephone or on a team key.

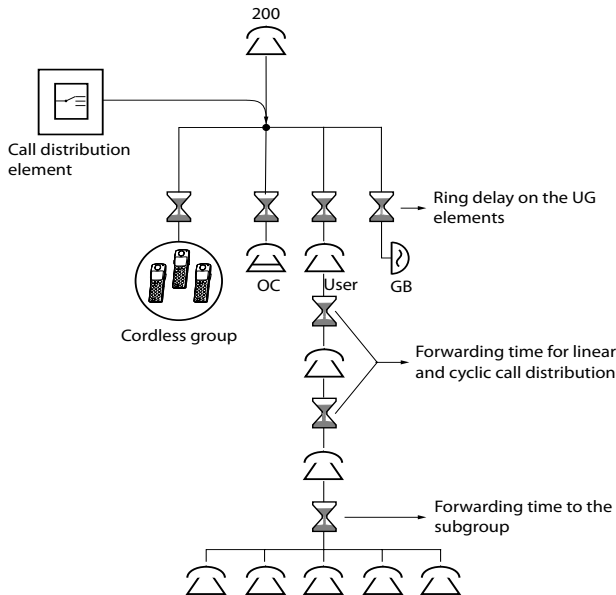

Fig. 63 Call distribution in a user group

Rules in the member group

Any member of a member group can use the menu selection or a */# function codes to log out of (#48xx) or log into (*48xx) a user group (see also "[User group: Logging in and logging out](#)", page 472). Members who have logged out of a group are ignored during call distribution. The last remaining member in a group does not have the possibility of logging out of the group.

A user may belong to several user groups at the same time. Logging out of or in to user groups applies simultaneously to all the user groups or specifically for one particular user group.



Note:

A maximum of 50 terminals can be called simultaneously for each call. This limit is quickly reached if a user group with global call distribution contains many users with several terminals. If so, only the first 50 terminals will ring, starting with the user group members with the lowest position number.

Call Forwarding Unconditional (CFU) for user group members

Activated CFUs of user group members to internal destinations are always carried out.

With CFUs to external destinations, PISN users, integrated mobile phone users or voice mail the response depends on the configuration:

Tab. 35 CFUs of user group members: System configuration

Parameter	Parameter value	Remarks
<i>Members remain in the UG in the case of external Forwarding</i>	<Yes / No>	Configuration per user group
<i>Remain in user group with external forwarding</i>	<Yes / No>	Configuration per user

A member remains in the user group when he activates a CFU to an external destination, a PISN user, an integrated mobile phone user or voice mail only if both parameters are configured to *Yes*.

If one of the parameters is configured to *No*, the CFU causes the member to be switched out of the user group. The last remaining member in the member group does not have the possibility of activating an external, PISN, mobile phone or voice mail CFU and cannot log out of the user group.



Notes:

- This response applies only to unconditional CFU (*21) but not to cyclic call distribution (*67) or CFNR (*61).
- If the communication server is connected to the PSTN via analogue network interfaces, a user group member with an external, PISN mobile phone or voice mail CFU is always switched out of the user group.

Cyclic call distribution and CFNR of user group members

*67 (Call Forwarding Busy) and *61 (Call Forwarding on No Reply) to any destinations can always be activated without causing the members to be excluded from the user group.

Special case call forwarding on no reply if busy:

Situation:

A user in a user group has activated CFNR to an internal destination (case A), an external destination (case B), a PISN user (case B), an integrated mobile phone (case B) or voice mail (case B).

The assigned permission set of this user has the parameter *CFNR if busy* configured to *Yes*. The user and all other members in the user group are busy.

Response to an incoming call:

Case A: The call forwarding on no reply is executed in each case.

Case B: The call forwarding on no reply is executed only if both parameters in Tab. 35 are configured to *Yes*. Otherwise, the response is as described in section "[Response if busy](#)" below.

Status of the user group members

The status of the UG members can be viewed for each user group under CM_2_1_5 in AMS. A distinction is made depending on whether the member was logged off manually or automatically by an external redirected call.

Response if busy

If all the members are busy, the system will respond as follows:

- An external call will be routed in accordance with the emergency routing concept (see "[Response if busy](#)", page 178).
- An internal call will be acknowledged with the busy tone.

Caller identification on the terminal

- Call identification during the signalling phase:
The name of the user group is displayed along with the CLIP
- Once a member has answered a call, an entry is made in the list of answered calls for this member.
If the call remains unanswered, it generates entries in the lists of unanswered calls of all the UG members. This can be suppressed for each user (CM_3_2_1, Tab [Authorizations](#), parameter *Unanswered calls via UG in call list*).

Cordless phones

Cordless phones like other terminals are assigned to a user. The following restrictions apply:

- Only one cordless phone is allowed per user.
- In the UGs 1...16 (Aastra 415/430) or 1...24 (Aastra 470) the group call is used for those DECT cordless phones on which the parameter *Busy if busy* is set to *No* with the allocated user. A DECT group call saves resources (DECT channels) compared with DECT individual calls.
- In each Location Area only 9 cordless phones can be searched for simultaneously using individual calls.

5.7.2 Large user groups

Any user group can be configured as a large user group in the system configuration (*Large user group = Yes*). Large user groups differ from ordinary user groups in the following ways:

- Apart from the general system limits there is no other restriction on the number of members in a member group.
- The elements operator console and general bell are not possible.
- Global call distribution is not possible
- Subgroups are not available
- They can be the destination of a Call Forwarding Unconditional or Call Forwarding on No Reply, even if the diverting user is still a member of a different user group.
- Any call diversion or call forwarding (even internal) by a UG member automatically results in the member being switched out of the user group. If there is only one member left in the member group, that member cannot activate CFU or CFNR and therefore cannot log out of the user group.
Note: In Twin Mode the user of the cordless phone and the user of the desk phone have to be entered in the user group.
- If a member makes outgoing external calls without a direct dialling number the direct dialling number of the user group is not used as CLIP.

5.7.3 User Groups for Voice Mail and Other Applications

User group 17 (Aastra 415/430) and user group 25 (Aastra 470) have been designed to accommodate a voice mail server.

User groups 18 to 21 (Aastra 415/430) or 26 to 29 (Aastra 470) are provided for applications that require a call forwarding to a user group.

These user groups differ from ordinary user groups in the following way:

- In the case of calls to these user groups, redirections of the UG user are not carried out. However, callers who dial the user in the user group directly are redirected.
- They can be the destination of a Call Forwarding Unconditional or Call Forwarding on No Reply, even if the diverting user is still a member of a different user group. In each case redirections to these user groups due to Call Forwarding will be carried out only once the call forwarding time has elapsed.

- It is not possible to divert these UG users to the special user groups. This applies even if the user logs out of the UG beforehand.
- Only the user group element "Member group" is available.
- *Global* call distribution is not available.
- It is possible to configure whether or not calls should generate an entry in the list of unanswered calls for the corresponding user whenever calls are diverted to these user groups (see [Tab. 217](#)).

The following applies in particular for the voice mail user group:

- Up to 16 voice channels (= user-group members) can be implemented for each user group.
- If the voice mail user group is not taken up by a voice mail application, it can be used for other applications.

5.7.3.1 User Groups 14, 15 and 16

After initialization, the element operator console and the first four users are entered as members in a user group 16.

After an initialization each trunk group is allocated call distribution element 1. It is allocated user group 16 as the destination for all three switch positions.

User group 16 is used as the destination in the following cases:

- No suitable DDI number is found for an incoming call and call distribution element 1 is entered in the trunk group configuration.
- An incoming call reaches a busy user group, triggers call waiting and call waiting is rejected.
- An incoming call is routed to a voice mail system via the voice mail user group, and the system is out of order due to a fault.



Tip:

As the user group is used as an emergency routing destination, the elements or members configured in this user group must be suitable as alternative destinations.

5.7.3.2 User group 14, 15 and 16¹⁾

- User group 16 is reserved for Capolinea destination 1 and 2.
- User group 14 is reserved for Capolinea destination 3.
- User group 15 is reserved for the switching variant of Capolinea destination 1 and 2 (see "[Capolinea](#)", page 149).

5.7.3.3 User groups 30 - 99



Note:

With user groups 30 - 99 (available only in the Aastra 470) no DECT group calls are possible, i. e. all cordless phones in these user groups are called individually. For many UG members with cordless phones this can quickly lead to a DECT system overload, with the result that not all cordless phones are called. Therefore use the cordless phones user groups 1 - 24 if there are many members (see "[Cordless phones](#)", page 139).

5.7.3.4 Application example for a user group

In the call distribution pattern, general bell has been configured with a delay; along with the operator consoles. This means that if the operator consoles is overloaded the general bell will also start to ring after the configured ringing time (e.g. 3 ringing cycles). The call can then be taken from any terminal.



Other Subjects Related to the User Group:

Call distribution, User configuration, Operator Consoles, General bell, Internal traffic, Incoming traffic, User group: logging in and out, Numbering plan.



Aastra Intelligent Net:

In an AIN the user group works across networks, i.e. the elements of a user group and the members of a member group can be spread across different nodes.

¹⁾ For Italy only

5.8 User Configuration

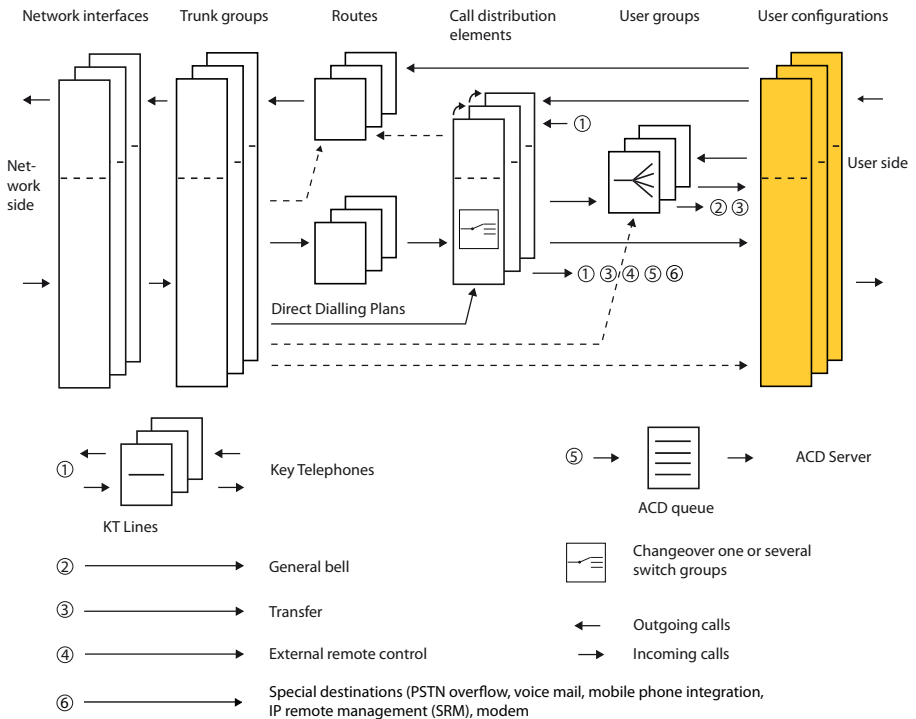

Fig. 64 User configuration in relation to the other routing elements

All the user- and terminal-specific settings are grouped together in the user configuration. This chapter deals with the following topics:

- Routing and identification-specific settings
- Settings for PISN users

5.8.1 Routing Functions for Incoming Calls

The incoming routing functions in the user configuration are as follows:

- for terminals, the allocation of the internal user number to one or more physical destinations (terminal interface, terminal selection digit and terminal type)
- for a cordless phone the logical allocation to a user identification stored in the phone

Several terminals can be allocated to an internal user. A call to this user is routed to all the terminals allocated to him or only to a number of them (see ["One Number user concept"](#), page 337).

5.8.2 Routing Functions for Outgoing Calls

The following outgoing routing settings are grouped together in the user configuration:

- Classes of service:
 - Exchange access authorization
 - Priority exchange allocation (see [page 202](#))
 - Digit barring, external (see [page 191](#))
 - Digit barring, internal (see [page 167](#))
 - Partial rerouting (see [page 231](#))
 - Least Cost Routing (see [page 206](#))
- Outgoing call number for PISN or integrated mobile phone users
- Route allocation
- Forcing the route if the LCR function if activated (see [page 219](#))

Rights

Enable or restrict authorizations to make outgoing phone calls to the public network from an allocated terminal. The following are excluded from the barring:

- Dialling abbreviated dialling numbers
- Dialling the emergency number
- Dialling PISN user numbers
- Dialling integrated mobile phone user numbers

Call Number of the PISN User for Outgoing Calls

If a PISN user is in a virtual network, his external (DDI) number will be listed here without the exchange access prefix. If a PISN user is in a fixed network, a number is not usually entered here (see ["Call to the private Leased-Line Network"](#), page 204).

For a more detailed description of which users of a different PINX can be entered as PISN users, see ["Shared Numbering Plan"](#), page 64.

Route allocation

This setting allocates a route to the user.

In the case of an internal user this route is used to route calls that were dialled with an exchange access prefix (except route selection). If the LCR function is activated, the route is determined by the LCR unless the user is authorized to force the route.

When a PISN user number is dialled, the route used is the one entered in the user configuration for that PISN user. If the LCR function is activated, the route will be determined by LCR.

The same applies accordingly when dialling an integrated mobile phone user as when dialling a PISN user.



Subjects Relating to User Configuration:

Terminal interfaces, Call distribution, Route, User group, Operator Consoles, Key telephones, Internal traffic, Incoming traffic, Outgoing traffic, Traffic in the PISN, User-related features, Numbering plan.

5.9 Operator console

The system has one switching centre, which is defined under the name *Operator console* in the internal numbering plan. Several operator consoles can be operated on the same communication server. There are two types of operator consoles:

- The Aastra 1560/1560ip and Office 1560/1560IP PC Operator consoles are OIP client applications which are connected via the mainboard's Ethernet interface. On the Aastra 1560 / Office 1560, voice is transmitted via the DSI interface of a system phone; on the beim Aastra 1560ip / Office 1560IP this done via IP, for example via a headset connected to the PC.
- In combination with an Aastra M535 additional keypad the Aastra 5380/5380ip system phone can be used as a digital operator console.
- The Office 45 system phone as an operator console connected to the DSI interface is supported as before.

With the exception of type-specific characteristics the following explanations apply to all types of operator console. Details and properties can be found in the type-specific documentation.

5.9.1 Routing Functions for Incoming Calls

Routing an Outside Call

Incoming calls are routed to the operator console(s) either directly or via a user group a call distribution element.

On an Aastra 5380/5380ip or Office 45 operator console the calls are provided on the line keys. If all the line keys are busy, other calls will be sorted into the call queue.

On an Aastra 1560 / Office 1560 the calls are entered in the external call queue. To answer the call the operator selects it directly from the call queue displayed on the graphic interface.

The operator can tell who the callers are from the call queue and can answer any of the call; the queue sequence does not have to be respected.

Routing Internal Calls

Internally the operator console is dialled up using the number of the switching centre defined in the numbering plan or via a call distribution element.

On an Aastra 5380/5380ip or Office 45 operator console the calls are provided on the line keys. If all the line keys are busy, the calls will be placed into the internal call queue.

On an Aastra 1560 / Office 1560, the calls are entered in the call queue for internal calls on the graphic interface. The operator select the call directly form the call queue.

Calls from the private leased-line network are handled in the same way as internal calls.

Routing a Personal Call (Internal or External)

The personal part of an operator console corresponds to an ordinary internal user. The calls are routed accordingly.

Call Signalling and Presentation on the Terminal

External and internal calls for the switching centre are signalled on all operator consoles.

Call Forwarding to a Substitution Destination

Calls to operator consoles can be diverted to a substitution destination (see "[Substitution Circuit](#)", page 159).

In a two-company system the call forwarding destination applies to both companies.

5.9.2 Routing Functions for Outgoing Calls

Routing an Outside Call

Seizing a line key enables direct network access and the network dialling tone is obtained. This means the user does not have to dial an exchange access prefix to be able to dial out into the public network.

Calls are routed via route 1 except in the case of a two-company configuration (see "Two-company system", page 147).

No CLIP is provided for outgoing calls via line keys.

If a call number from the display or from a card file is preceded by an exchange access prefix with a hyphen, the prefix is truncated when dialling via a line key.

Example:

The display on the operator console indicates the number: 0-222 30 30. If a call is set up with this number via a line key, the number 222 30 30 is dialled and the call is transmitted to the public network via route 1.

Routing an Internal Call

Internal calls (on the Aastra 5380/5380ip and Office 45 calls set up via the personal key) are routed in the same way as an ordinary internal user.

The CLIP consists of the personal internal user number.

On the Aastra 1560 / Office 1560 the operator console number and a name can be added instead of the personal internal user number for calls from the internal call queue. (Configuration in AMS CM_1_2_3)

Routing a Personal Call (Internal or External)

The personal part of an operator console corresponds to an ordinary internal user. The calls are routed accordingly.

The CLIP consists of the personal internal user number.

5.9.3 Two-company system

On a two-company system the operator console will indicate whether an incoming call is intended for Company A and B (see Fig. 65 as an example for Office 45).

The configuration as a two-company system only affects the display on the operator console. The following points need to be taken into account to ensure that the two-company operation is clearly separated:

- Use a separate direct dialling plan for each company.
- Allocate separate cost centres for each company.
- Use an internal digit barring,
 - if internal traffic between the companies is not possible.
 - to prevent outside cost centres from incurring charges through cost centre selection or route selection.

A: Müller D.	023 624 20 12	External	10:22
B: Brown & Co.	031 995 23 12	External	10:25
I: Willi	29811		10:25
---Line key	1...5-----		
Brown & Co.	031 995 23 12		

Fig. 65 Display on the operator console Office 45 in two-company mode

Routing an Incoming Call to the operator console

The company allocation of a call depends on the setting in the relevant call distribution element (see "[Other Functions and Settings of the CDE](#)", page 128).

Routing an Outgoing Call from the operator console

External outgoing calls from Company A are routed via route 1; external outgoing calls of Company B, via route 2.

Call Logging of Calls on the Operator Console

Call data, whether incoming or outgoing, is not logged separately according to company.

Default setting

Upon initialization all call distribution elements are configured for Company A (single-company system).

5.9.4 Capolinea¹⁾

The purpose of the Capolinea feature is to ensure that each incoming call is answered. Therefore calls not answered by the destination users are routed to alternative destinations (see "Response if busy", page 178). Operator consoles are used as alternative destinations.

Capolinea Destinations

Unlike the standard operator function in the system, Capolinea has three destinations for operator consoles. They are defined throughout the system using the *Capolinea Destinations* setting (entering the internal user numbers of the operator consoles).

Routing to a Capolinea Destination

An unanswered incoming call is routed to one of the user groups 16, 15 or 14. The following Capolinea destinations are allocated to the *Operator console* user group elements:

- In user group 15 and 16
 - Capolinea destination 1 is allocated for Company A.
 - Capolinea destination 2 is allocated for Company B.
- In user group 14, Capolinea destination 3 is allocated.

User group 15 acts as a night service variant to user group 16.

An unanswered recall in response to *Transfer without prior notice* is also routed to a Capolinea destination (see "Call transfer without prior notice", page 375).

Configuration Notes

Tab. 36 Destination configuration in the call distribution element:

Capolinea destination	Switching position	Company	Destinations
1	1 (Day)	A	User ¹⁾
1	2 (Night)	A	User + UG 15
2	1	B	User + UG 16
2	2	B	User + UG 15
3	1	A	User + UG 14

¹⁾ Only for Italy

1) Here UG 16 is already configured and hidden as the destination; therefore it no longer has to be specially set ($User = User + UG\ 16$)

Tab. 37 Configuration for user groups

User group	Elements configured	Default value:
14	Operator console delayed	–
15	Operator console, delayed, or general bell, delayed	Operator console delayed
16	Operator console delayed	Operator console delayed

Do not use the user groups for purposes other than Capolinea.



Aastra Intelligent Net:

In an AIN the availability of Capolinea depends on the Master settings. If the *Country* parameter is configured to *IT* on the Master, Capolinea is available throughout the AIN.



Other Subjects Related to the Operator Console:

Terminals, Aastra 1560 / Office 1560 PC operator console, user-related features, numbering plan

5.10 General bell

Calls with the general bell as destination can be signalled visually or acoustically using an external supplementary equipment. The call can be taken from any terminal (see "Answer general bell", page 456).

5.11 Key telephones

Key telephones have several line keys and an personal key. For incoming traffic each line key of a key telephone is a routing destination addressed using the relevant call distribution element. This means for example that calls with a different DDI number can be offered on any line key.

For outgoing traffic each line key is linked with a separate routing. This means for example that a specific exchange line can be used for dialling by operating a line key.

With the personal key a key telephone can be operated like an ordinary feature-phone.

5.11.1 Using Terminals as Key Telephones

The following system phones can be configured as key telephones:

- Office 35
- Office 45/45pro
- Aastra 5370/5370ip
- Aastra 5380/5380ip

A system phone automatically becomes a key telephone as soon as a KT line is placed on one of the phone's line keys.

Key Functions

After a featurephone is converted to a key telephone, it gets one or more line keys and a personal key. The other keys remain freely configurable in the same way as on a featurephone.

The locations of the line keys and personal key can be configured independently of each other. It can be this, a configurable keypad on the phone or an expansion keypad.

The personal key allows the key telephone to be addressed and used in the same way as an ordinary internal user, in accordance with the settings in the user configuration.

The maximum number of line keys possible depends on the type of system phone.

The key telephone can be set in such a way that an incoming or outgoing call on a line key is either automatically allocated a KT line or automatically answered, as the case may be. Depending on the type of phone the line keys can be provided with up to 9 priority levels (see the system phone's User's guide).

Signalling

A call on a KT line is signalled both acoustically and visually. The status of the KT lines is indicated by LED signalling. The status of the KT lines is indicated by LED signalling.

Tab. 38 LED signalling on the line keys of a key telephone

LED signalling	Meaning
LED flashing rapidly	Call on that line
LED lit	Line is seized
LED flashing slowly	Line is parked

5.11.2 KT lines and Line Keys

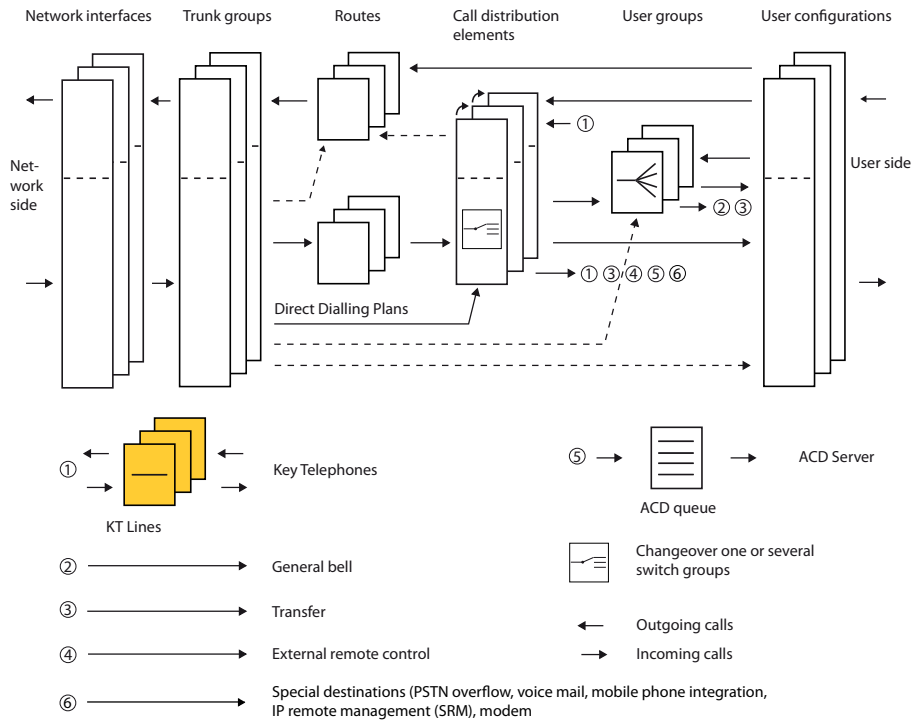

Fig. 66 Key telephones in relation to the other routing elements

KT Lines

Each call distribution element is allocated under its reference number one or more lines for key telephones (KT lines) if *KT* (or destination combinations with that destination) has been set as the destination (see "Call destination", page 122).

Line Keys

Each line key of a key telephone is allocated to a KT line. For example one line key is allocated to KT line "1/1", another to KT line "1/2". The first digit is the reference number of the call distribution element; the second digit is the line number. It also indicates the priority with which calls are offered on the line.

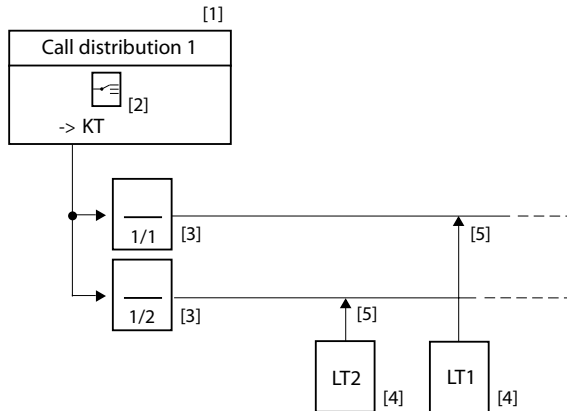

- [1] Call distribution element with reference number 1
- [2] Set destination: KT or combinations with KT
- [3] KT lines
- [4] Line keys on the same or different key telephones
- [5] Allocation of the line key to a KT line

Fig. 67 Allocating line keys

Terminating KT Lines and through KT Lines

Any number of line keys from different key telephones can be allocated to the same KT line. If only one key telephone is allocated to one or several identical KT lines, we talk of a terminating KT line (TL). If several line keys of different key telephones are allocated to the KT line, we talk of a through KT line (THL).

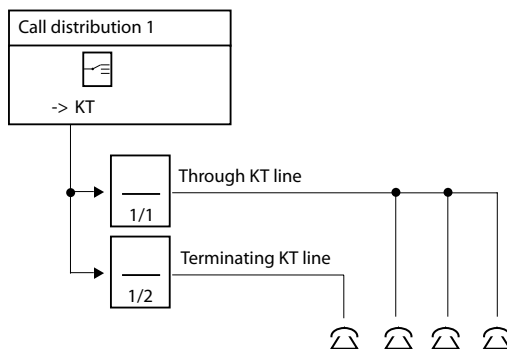

Fig. 68 Through and terminating KT lines

**Note:**

Unlike call forwarding to terminating KT lines, call forwarding to through KT lines are not carried out.

**Tip:**

Calls to through KT lines are normally answered by substitution by the other connected key telephones.

A destination assignment in the configuration of the call distribution element depending on the switching position of the switch group can be used to achieve an overflow for connections on a through KT line. For example Call Forwarding on No Reply to general bell or the operator consoles can be configured in combination with a delayed user group.

5. 11. 3 Incoming Calls via a KT Line

All calls can be routed to a KT line if the destination *KT* is defined in the corresponding call distribution element:

- Calls from the public ISDN network
- Calls from the public analogue network
- Calls from the private network
- Internal calls

If an incoming call reaches a busy KT line, the call is routed to the second KT line. If the second line is also busy, the call is routed to the third KT line, and so on. If there are no more KT lines available, busy is signalled. If "CDE if busy" is configured, the call is routed via the call distribution element.

**Note:**

If a call is routed to a KT line to which no line key is connected, the call will simply idle or be routed to the alternative destination (setting *CDE if no answer*).

Transferring from a Key Telephone to another Destination

Each connection on a KT line can be transferred to any internal user. For this simply press the personal key.

If a key telephone user is already making an internal call and wants to answer a call on a line key, the response depends on the parameter *Internal brokering/line key* in the user settings:

- If the parameter is set on *No*, the internal user (in order to maintain the connection) must first be parked before the call can be answered on the line key. In return the external call can be forwarded directly using the personal key.
- If the parameter is set on *Yes*, the call can be answered directly on the line key and the internal user is automatically parked on the personal key. To forward the external call internally, initiate an enquiry call.

Transferring to a Key Telephone

A call transferred to a key telephone is offered on the key telephone's personal key or on a line key. If the call comes from the public network, it is signalled with the external ringing pattern.

Transferring to a key telephone with prior notice:

- If a call is transferred to a key telephone that is already receiving the call via a line key, it is offered on both the personal key and the line key. The call can be answered using either key.
 - If the call is answered using the personal key, the user will be connected to the transferring party.
 - If the call is answered using the line key, the user will be connected to the caller.
- If a call is transferred to a key telephone that is not receiving the call via a line key, it will be offered on the personal key only.
If the call is answered, the user will be connected to the transferring party.

Transferring to a key telephone without prior notice:

- If a call is transferred to a key telephone that is already receiving the call via a line key, the call will be offered on the line key only. If the call is answered, the user will be connected with the caller.
- If a call is transferred to a key telephone that is not receiving the call via a line key, it will be offered on the personal key only.
 - If the call is answered, the user will be connected with the caller.
 - If the call is not answered, it will be offered again to the transferring party once the recall time has elapsed.

Identifying a Call

System phones with a display will indicate the name of the call distribution element if the call distribution element is configured with *Force showing DDI number = No* (default setting).

They will indicate the DDI number via which the call has been routed if *Force showing DDI number = Yes*.

5. 11. 4 Outgoing Calls via a KT Line

A KT line can be configured either as an outgoing line to the network or as a normal internal line.

KT Line as an Outgoing Line to the Network

Direct network access is enabled when a call is set up: The network dialling tone is obtained. This means the user does not have to dial an exchange access prefix to be able to dial out into the public network. The route is determined by the *KT route* setting in the call distribution element.

If the call number dialled is a number with an exchange access prefix and a hyphen.

Example:

The display on the key telephone indicates CLIP number: 0-222 30 30. If an outgoing call is initiated by dialling this number, the number 222 30 30 is dialled and the call is transmitted to the public network via the configured KT route.

To enable outgoing calls to the public network, *Outgoing barring = No* must be set in the key telephone configuration. The setting *Outgoing barring = Yes* does not enable outgoing calls to be set up via this KT line.

The call charges can be logged via the *KT cost centre* setting.

KT Line as a normal Internal Line

If no KT route has been defined in the call distribution element (*KT route = -*), the KT line will respond like an ordinary internal line. This means the user has to dial an exchange access prefix to be able to dial out to the public network. The route is determined by the *Route* setting in the user configuration.

Furthermore, the other settings in the user configuration also apply.

The following number is presented as CLIP to the internal destination user:

- The call number of the call distribution element, provided it has been allocated in the numbering plan.

- The internal call number of the key telephone if the call distribution element was not allocated a call number.



Note:

If a KT cost centre is entered in the call distribution element and a user cost centre in the user configuration, the call charges are allocated to both cost centres. This means the total sum of the call is allocated twice.

5.11.4.1 Application Examples for Key Telephones

Destination Combination KT+UG

The combined destination KT line and user group 5 has been configured in call distribution element 1 with number 200 in the numbering plan.

Two line keys are connected to the KT line 1/1. It is therefore a through KT line. The first line key belongs to the key telephone with user number 211; the second belongs to the key telephone with user number 221.

The element *Operator console* is configured on user group 5. Internal user 291 is entered as member of the member group. Delay is activated for both elements (Operator console and user).

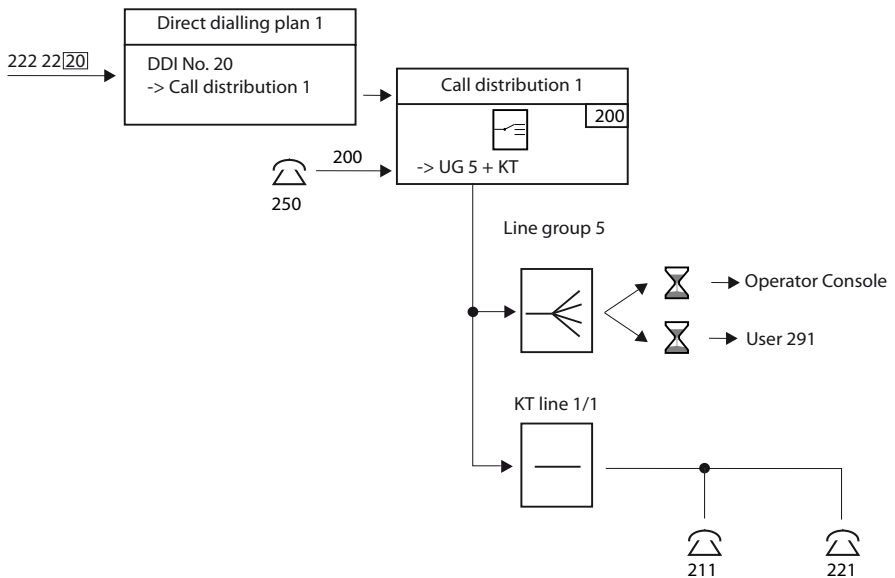

Fig. 69 Application for key telephones and user group

If an incoming call is not answered within the set delay time using the line keys of users 211 or 221, the call will be routed on to user group 5 and signalled at the same time to the operator console and user 291.

5.11.4.2 Destination KT

Travel agency Application

The number for the travel agency's Africa Desk is listed in the telephone directory under the number 222 22 20.

Calls for travel to Africa are first route to the Africa Desk At the Africa Desk the calls are answered by employees 1 to 3.

A call is offered on the line keys of KT line 1/1.

If KT line 1/1 is busy, the call is offered on the line keys of KT line 1/2, etc.

The travel agents working at the Europe Desk will only answer calls to the Africa Desk if all its three travel agents are busy. That is why they are only connected to the KT line for Africa in fourth priority (KT line 1/4).

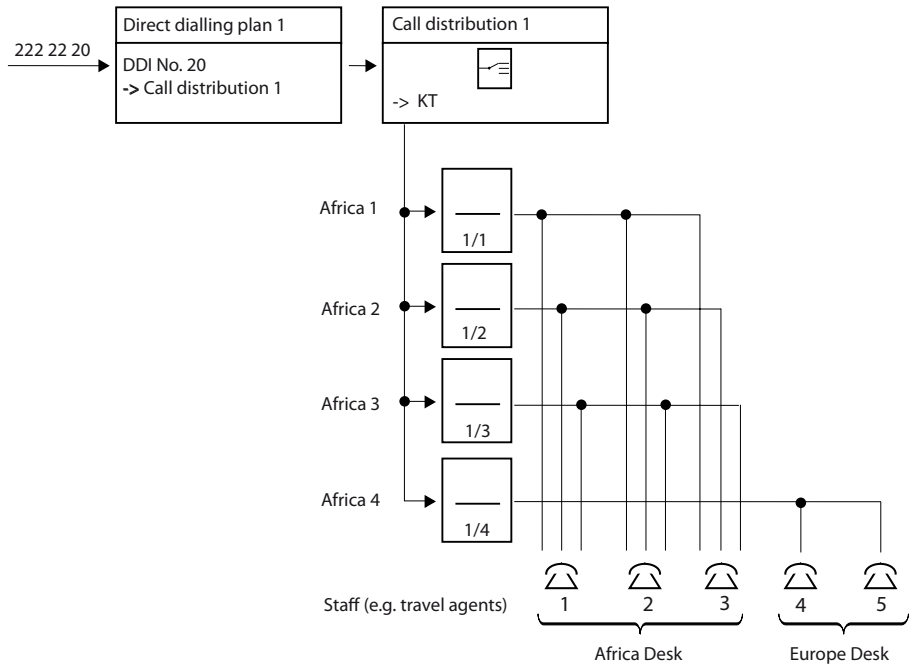

Fig. 70 Substitution Circuit

Substitution Circuit

The first call is answered by the manager personally; a second simultaneous call will ring on the deputy manager's set; the third call will ring in the secretary; the fourth caller will obtain "busy". The calls can be visually signalled everywhere immediately. Acoustic signalling takes place after a delay.

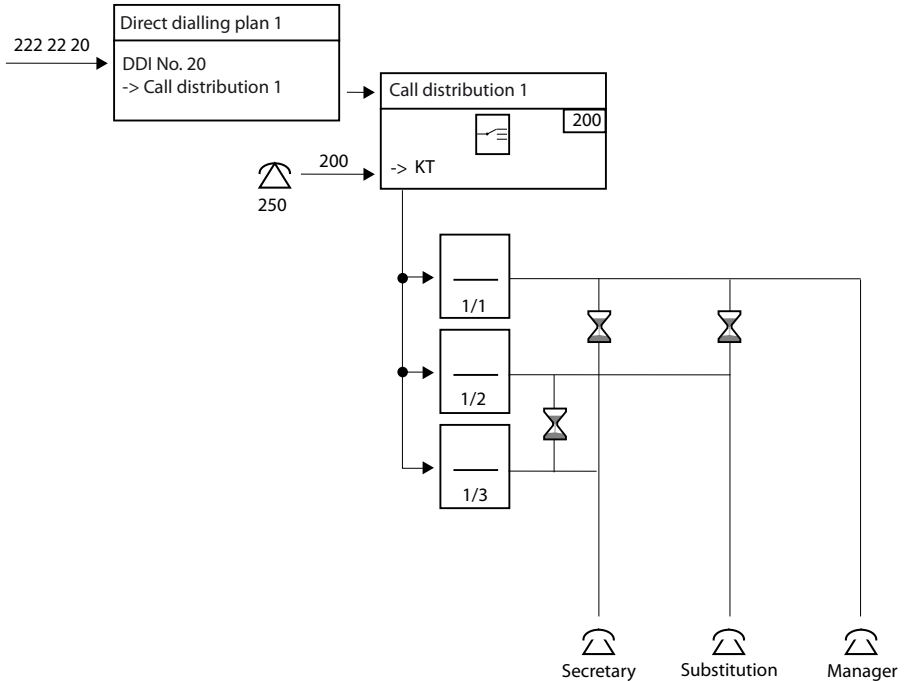

Fig. 71 Substitution circuit with key telephones



Other Subjects Relating to Key Telephones:

Terminals, Internal traffic, Incoming traffic, Outgoing traffic, User-related features.

5.12 ACD Server

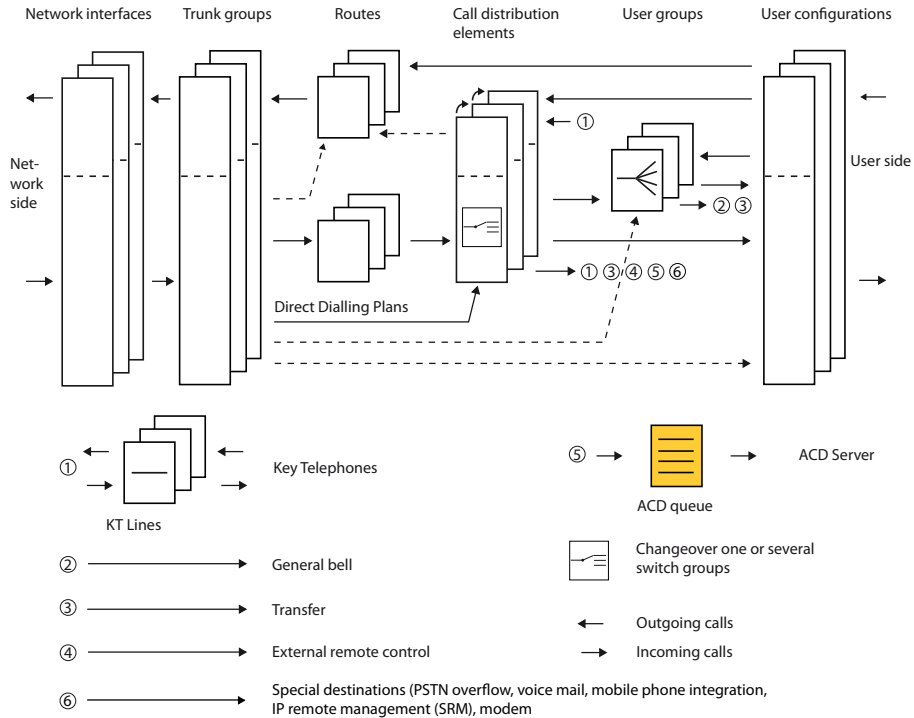

Fig. 72 The ACD server in relation to the other routing elements

With an ACD application on the third-party CTI interface, control of the call routing is shifted from the communication server to the external ACD server (ACD: Automatic Call Distribution). The ACD application determines the routing and the communication server routes call according to its default settings.

Calls to an ACD server are routed to the ACD queue where they are sorted (ACD destination in the call distribution element settings).

The communication server informs the ACD server of the calls in the ACD queue. The ACD server analyses the calls and tells the communication server where to route the calls. Potential destinations are internal users and PISN users (e.g. agents working from home).

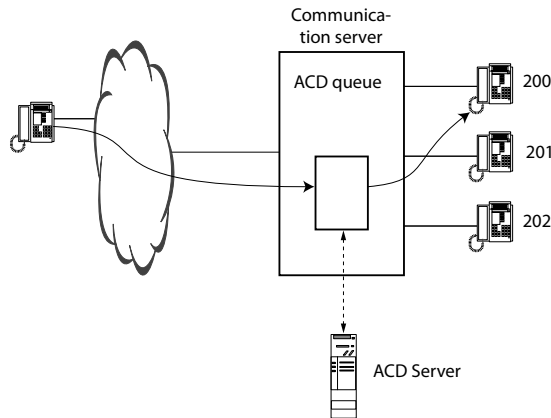

Fig. 73 Communication server call routing controlled by the ACD server

If the call is not answered by the destination user (agent) after a set time has elapsed (*ACD ringing duration*) or if the destination user is busy, the communication server returns the call to the queue and informs the ACD server accordingly.

Utilization of the ACD queue is subject to the acquisition of a licence.



Note:

For the ACD server to analyse calls correctly, *Force showing DDI number = Yes* has to be configured in the direct dialling plan.

Call Routing in the event of an ACD Server Failure

Alternative destinations have to be defined so that calls can be routed to a destination even in the event of an ACD server failure (see "[Alternative Destinations](#)", page 124).

If the ACD server fails, an event message is generated (*ACD server out of operation*).

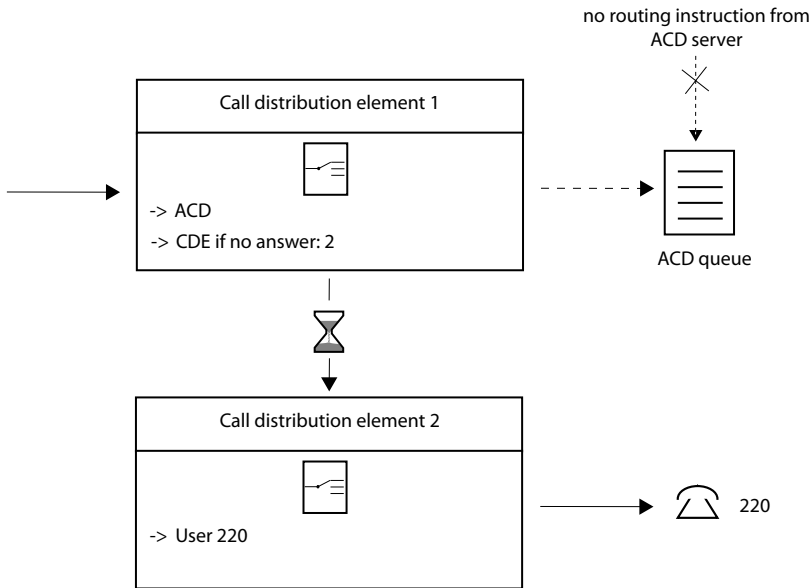

Fig. 74 Emergency routing in the event of an ACD server failure

If the same call routing as with the ACD server is to be achieved, the ACD server configuration has to be replicated in the system configuration also (for example ACD agent groups have to be replicated as user groups in the PBX configuration).

6 Call routing

This Chapter describes the interplay between the routing elements for the various types of traffic: call routing for internal, incoming and outgoing traffic. Other topics include Least Cost Routing, exchange-to-exchange traffic, transit routing in the private leased-line network, overflow routing and break-out.

6.1 Overview

This chapter is divided as follows:

- [Internal traffic](#) (as of [page 163](#))
- [Incoming Traffic](#) (as of [page 168](#))
- [Outgoing traffic](#) (as of [page 190](#))
- [Least Cost Routing \(LCR\)](#) (as of [page 206](#))
- [Exchange-to-Exchange Connection](#) (as of [page 223](#))
- [Transit Routing in the Private Leased-Line Network](#) (as of [page 237](#))
- [Testing overflow routing in the PISN](#) (as of [page 246](#))
- [Break-Out](#) (as of [page 251](#))

6.2 Internal traffic

6.2.1 Internal Destinations

Many internal destinations are allocated numbers in the internal numbering plan. These destinations are dialled directly by dialling these numbers or the names allocated to them.

The table below shows the internal destinations, their availability and their dialling options.

Tab. 39 Internal destinations and their availability

Internal destinations	Remarks
Internal users assigned one or more terminals: <ul style="list-style-type: none"> • Digital system phones • Terminals on the S bus 	Selectable using number and name selection

Internal destinations	Remarks
<ul style="list-style-type: none"> • Analogue terminals • Aastra SIP terminals and standard SIP terminals • IP system phones • Cordless phones • Integrated mobile phones • Virtual terminals 	External mobile number stored
Internal destinations to which another destination has been permanently allocated: <ul style="list-style-type: none"> • Emergency number • Abbreviated dialling numbers • PISN users 	<ul style="list-style-type: none"> • Selectable using number dialling only • Destination No: internal, external, PISN users • Selectable using number and name selection • Destination No: internal, external, PISN users • Selectable using number and name selection • Destination No: PISN internal (users on other PINX in the PISN)
Central destinations: <ul style="list-style-type: none"> • Operator console • General Bell 	Selectable using number dialling only Selectable only indirectly via a user group or via coded ringing
Door Intercom Systems	<ul style="list-style-type: none"> • Selectable using number and name selection • Dialling: can only dial predefined destination
Distribution elements: <ul style="list-style-type: none"> • User groups • Call Distribution Elements • KT lines on key telephones 	Selectable using number and name selection Directly selectable only via number selection <ul style="list-style-type: none"> • Selectable using number selection of the relevant call distribution element. • Dialling: using allocated line keys
Routing elements: <ul style="list-style-type: none"> • Routes 	Directly selectable only via number selection

6. 2. 2 Dialling internal destinations via external call numbers

Internal users can also reach internal destinations by dialling an external call number with the help of an allocation table in AMS. This is particularly helpful when dialling with the aid of a phone book directory. In this way an internal and an external call number do not have to be stored in the phone book directory.

When the communication server recognizes that it is an external call number, the call number is checked against the entries in the allocation table (CM_2_1_12). If the dialled call number matches an entry, the assigned internal call number is di-

alled instead of the external call number. If no match is found, the external call number is dialled.

Note:

If the dialled number does not contain a country code, the country code defined in the corresponding AIN region (CM_1_2_11) is automatically added to the call number before the table is checked. This makes it possible to dial the call number with or without the country code.

Example Switzerland:

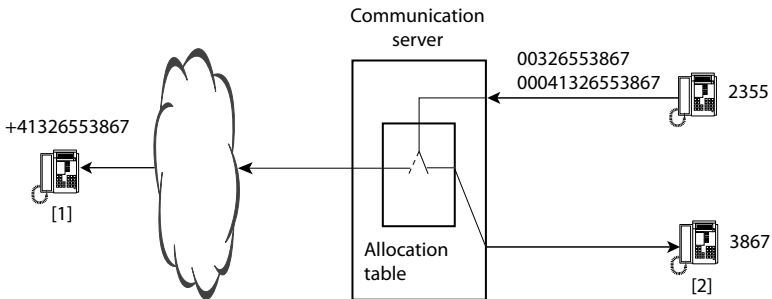

[1] The call is routed to external if no entry is found for the dialled number in the allocation table.

[2] The call is routed to the internal destination which is assigned in the allocation table of the dialled external number.

Fig. 75 Routing to an internal destination via the allocation table

Configuration:

- *AIN Region – Country code:* 41
- *Numbering plan – Exchange access, business:* 0
- Entry in the allocation table:
 - *External call number:* +41326553867
 - *Internal call number:* 3867

A call to the following phone numbers is routed to internal destination 3867:

- 00326553867
- 00041326553867

Note:

Instead of *Exchange access business*, the digits for *Exchange access private*, *Cost centre selection* or *Route selection* can also be used.

Restrictions:

- Dialling from analogue terminals is not possible.
- Dialling from the system phone, ISDN terminal, SIP terminal or PISN user must be done using bloc dialling. En-bloc means that the complete number is sent to the communication server in one go. This is the case when dialling from a memory (call list, repeat dial register, phone book etc.) or with call preparation via the keypad.
- Permissible internal destinations: Internal users, User groups, Call distribution elements and PISN users.
- In the allocation table external call numbers are to be entered in canonical format (starting with "+" followed by the country code). Several entries with identical external call numbers are not permitted. Multiple internal destinations, however, are permitted.

Special case of the integrated mobile phone:

When dialling from an integrated mobile phone, the call number is sent sequentially by means of DTMF signals. In this case a 4-second timer is started after each digit. Comparison with the entries in the allocation table is carried out only after the timer expires or when the dial completion sign (#) is recognized.

Supporting the canonical number format

The international number format beginning with the "+" sign is supported (canonical number) for DSI system phones, IP system phones, SIP terminals and integrated mobile phones. This enables, for example, SIP-based dual mode terminals (WLAN/mobile) with the same stored number, depending on the mode, to reach a user via mobile network (external) or via WLAN (internal). The following behaviour applies to these terminals:

- The communication server changes the "+" to a "0" (*Exchange access business*).
- Sometimes call numbers are given the following signs for better readability: "-", "/", "(", ")" and "blank". These signs are filtered out by the communication server before dialling.
- If a call number contains the country code as well as the national prefix, the national prefix can also be automatically filtered out. To do that, the digits in the [List of countries](#) (CM_1_2_12) have to be entered.

Example:

Entry in country list: *Country Code*: +41, *National prefix*: 0

Call numbers +41 (0)32 655 3867 and +41 (032) 655 3867 are converted to +41326553867.

Covering number ranges

By using one or more placeholders in the allocation table, entire number ranges can be covered with one entry.

Tab. 40 Examples with placeholders

<i>External call number</i>	<i>Internal call number</i>	Result
+41 32 655 386x	386x	10 external call numbers are routed to 10 internal destinations.
+41 32 655 44xx	44xx	100 external call numbers are routed to 100 internal destinations.
+41 32,655 55xx	21xx	The 100 external call numbers with the end digits 5500...5599 are routed to the 100 internal call numbers 2100...2199.

Please note:

- Either "x" or "X" can be used as a placeholder (stands for digits 0...9)
- The entry under *Internal call number* may not contain placeholders only ("xxxx" is not permitted)
- Placeholders are permitted on at the end of an entry ("4x4" is not permitted)
- *External call number* and *Internal call number* must always have the same number of placeholders.
- When the table is searched, the call numbers without placeholders are compared first, then the call numbers with 1 placeholder and so on. This makes it possible to define certain exceptions concerning number ranges.

6. 2. 3 Internal Digit Barring

There are several digit barring options available for internal traffic. The same rules apply as for external digit barring facilities (see "[Digit barring](#)", page 191).

6. 2. 4 Internal ringing duration

The ringing time for an internal user can be configured from 30 to 18000 seconds in the AMS Configuration Manager using the *Internal ringing duration*. The call connection is disconnected once that time has elapsed. The timer is restarted if the call is forwarded after a set time (e.g. with *Call Deflection* or *Default call forwarding if no answer*).

**Note:**

With calls from the PSTN the connection is cleared down by the network provider, usually after approx. 2 minutes.

If the external call is answered by the announcement service, the call is considered as switched through for the PSTN. As long as the caller is switched to announcement service, a ringing tone is generated internally. The configured internal ringing time is therefore also a decisive criterion for clearing down the connection.

6.3 Incoming Traffic

6.3.1 Routing

Network interfaces with the same network-specific characteristics are all grouped together in a trunk group. It is for example specified whether the network interfaces allocated to a trunk group are connected to a private leased-line network or to the public network.

A call is routed via a trunk group to a direct dialling plan, a call distribution element or a destination with a number from the internal numbering plan.

Each direct dial number is allocated a call distribution element. Several direct dial numbers can be allocated to the same call distribution element.

A call distribution element is allocated destinations depending on the switch group and switch position (see "[Call destination](#)", [page 122](#)).

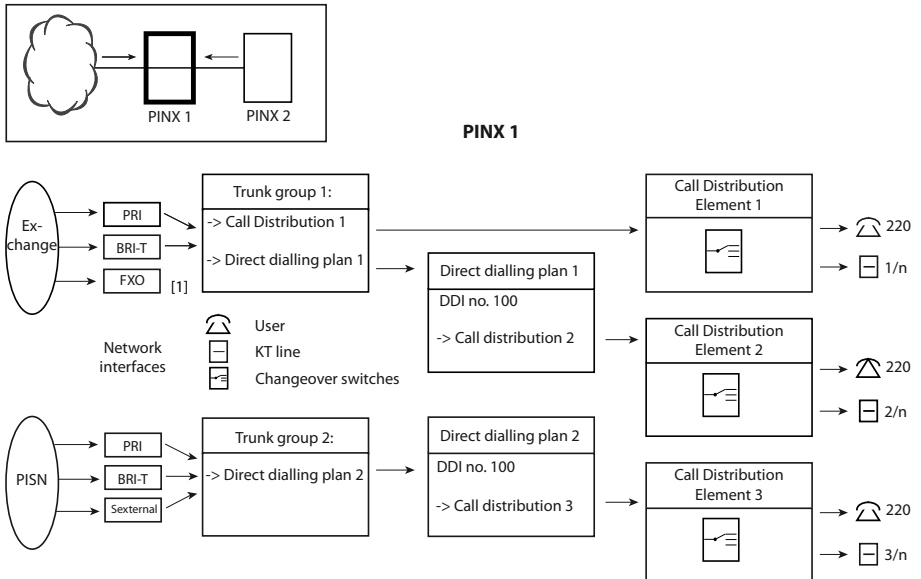

Fig. 76 Routing and destinations of an incoming call

Call routing depends in principle on whether a call originates

- from the public network or
- from the private leased-line network (QSIG) and
- whether there is a suitable direct dial number for the phone number.

In terms of call routing, calls from a virtual PISN are handled in the same way as calls from the public network.

The diagram below shows how an incoming call is routed:

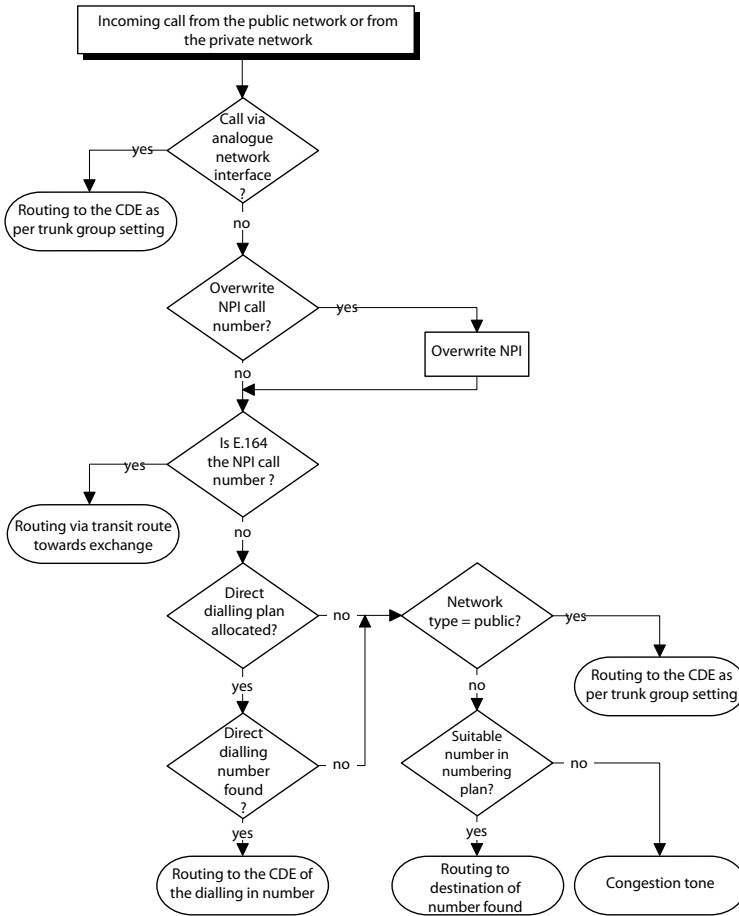

Fig. 77 Routing an incoming call

6.3.1.1 Call from the Public Network

A call with a suitable direct dial number is routed to the destination via the call distribution element allocated in the direct dialling plan.

If a suitable direct dial number is not found, the call is routed in the same way as a call from the public network without direct dialling (see "Routing without Direct Dialling", page 172).

Direct dialling is not supported for calls from the analogue network.

Routing with Direct Dialling

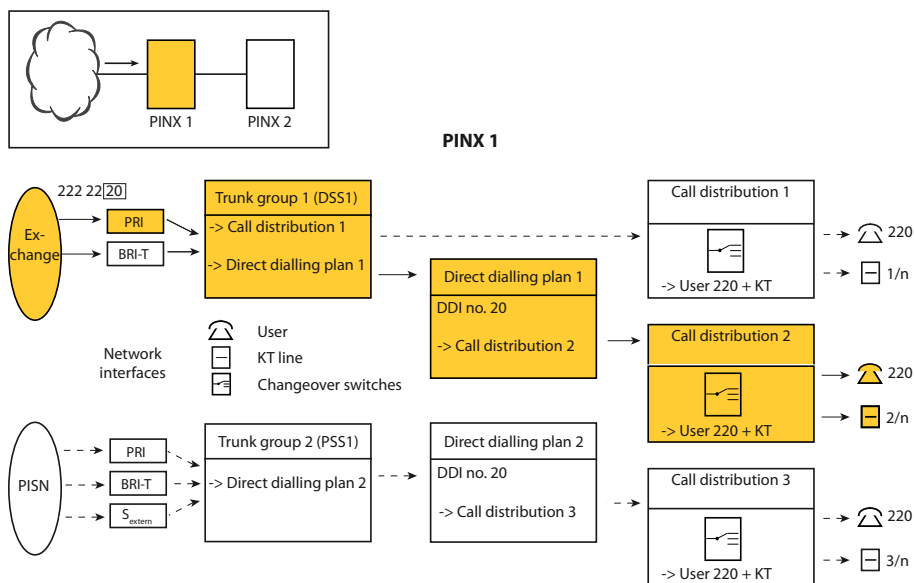

Fig. 78 Routing a call from the public network with direct dialling

Tab. 41 Setting the routing parameters

Parameter	Parameter value
Trunk group 1: <ul style="list-style-type: none"> • <i>Network interfaces</i> • <i>Incoming connection</i> • <i>Network type</i> • <i>Protocol</i> • <i>Overwrite NPI</i> • <i>Direct dialling plan</i> • <i>Call Distribution Element</i> 	Network interfaces in this trunk group Number of connections allowed simultaneously <i>Public</i> <i>DSS1</i> <i>no</i> 1 (number of a direct dialling plan) 1 (significant only if a suitable direct dial number is not found)
Direct dialling plan 1: <ul style="list-style-type: none"> • <i>Direct dialling number 20</i> 	2 (reference number of a call distribution element)
Call distribution element 2: <ul style="list-style-type: none"> • <i>Destinations</i> • <i>Incoming connections</i> 	<i>Switch position 1: User 220 + KT</i> Number of connections allowed simultaneously

Routing without Direct Dialling

A call without a suitable direct dial number is routed to the call destination via the call distribution element allocated in the trunk group.

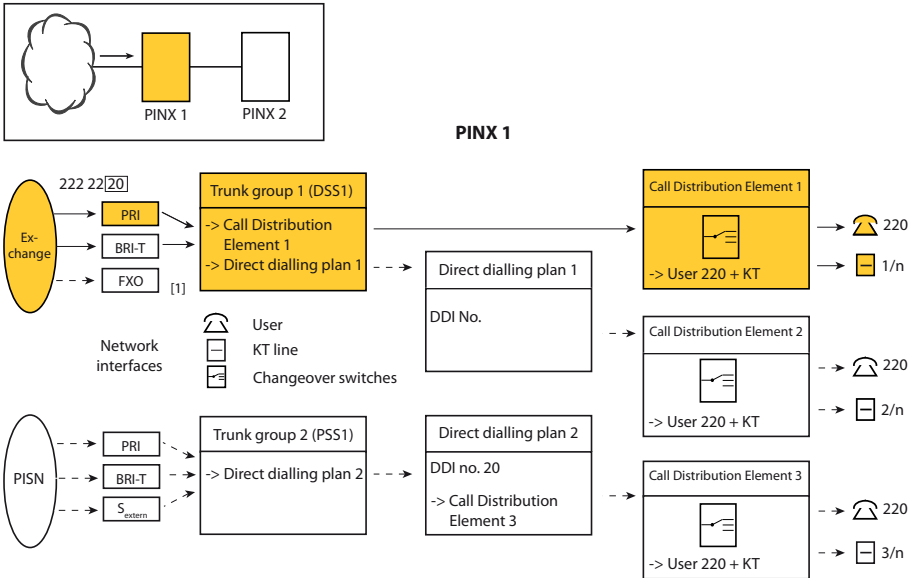

[1] One and the same trunk group cannot contain both analogue and digital network interfaces.

Fig. 79 Routing a call from the public network without direct dialling

Tab. 42 Setting the routing parameters

Parameter	Parameter value
Trunk group 1: <ul style="list-style-type: none"> • Network interfaces • Incoming connection • Network type • Protocol • Overwrite NPI • Direct dialling plan • Call Distribution Element 	Network interfaces in this trunk group Number of connections allowed simultaneously Public ¹⁾ DSS1 ¹⁾ no ¹⁾ 1 (relevant only if a suitable DD number is found) 1 (reference number of a call distribution element)
Call distribution element 1: <ul style="list-style-type: none"> • Destinations • Incoming connections 	Switch position 1: User 220 + KT Number of connections allowed simultaneously

¹⁾ Not relevant for trunk groups with analogue network interfaces

6.3.1.2 Call from the Private Leased-Line Network

In the private leased-line network, direct dialling plans are set up only if calls are to be routed to their destinations via call distribution elements in order to benefit from the advantages of the flexible routing properties of call distribution elements (see "Call Distribution Element (CDE)", page 121).

Call distribution elements can be dialled up directly if they have been allocated a phone number in the numbering plan and if they exist as PISN users in the other PINXs. However, without a direct dialling plan it is more difficult to achieve a numbering that matches.

Tab. 43 Flexible routing with and without direct dialling plan; difference in numbering

	PINX 2 PISN users	PINX 1 DDI number	PINX 1 Call Distribution Element	PINX 1 Destination user
with direct dialling plan	250	250 → 250	1	250
without direct dialling plan	250	–	1, phone number 250	251

Calls from the private leased-line network do not have any DDI numbers. If you set up a separate direct dialling plan, however, these numbers can also be handled in the same way as DDI numbers.



Tip:

Only individual numbers can be organized via a direct dialling plan; the others are organized directly in a numbering plan.

Routing with Direct Dialling

A call with a suitable number in the direct dialling plan is routed to the destination via the call distribution element allocated there.

If the first few digits of the phone number match the number entered under *Own regional prefix* in the numbering plan, they will be truncated before the search for a suitable direct dial number is carried out.

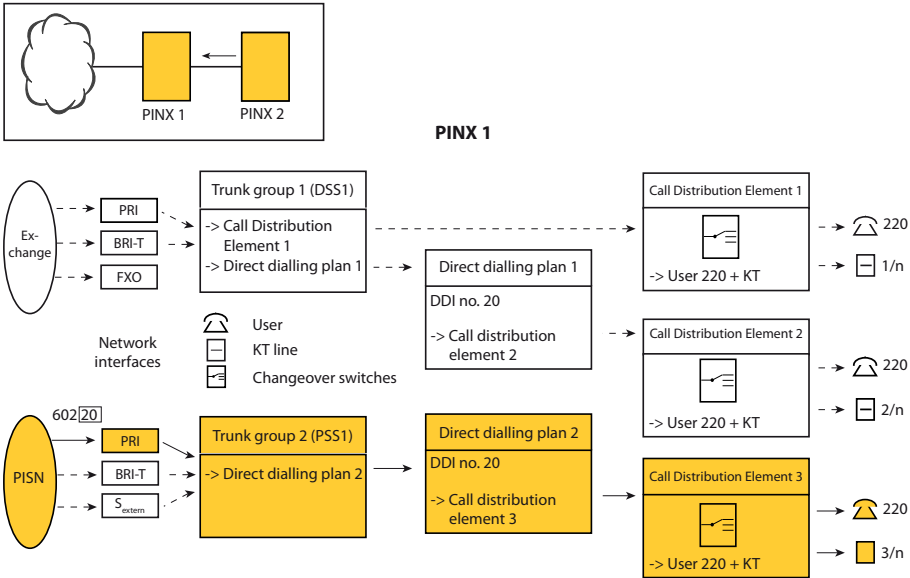

Fig. 80 Routing a call from the private leased-line network with direct dialling

Tab. 44 Setting the routing parameters

Parameter	Parameter value
Trunk group 2: <ul style="list-style-type: none"> • <i>Network interfaces</i> • <i>Incoming connection</i> • <i>Network type</i> • <i>Protocol</i> • <i>Overwrite NPI</i> • <i>Direct dialling plan</i> • <i>Call Distribution Element</i> 	Network interfaces in this trunk group Number of connections allowed simultaneously <i>Private</i> <i>QSIG</i> or <i>QSIG / PSS1 ISO</i> <i>no</i> 2 (number of a direct dialling plan) Not relevant to this case
Direct dialling plan 2: <ul style="list-style-type: none"> • <i>Direct dialling number 20</i> 	3 (reference number of a call distribution element)
Call distribution element 3: <ul style="list-style-type: none"> • <i>Destinations</i> • <i>Incoming connections</i> 	<i>Switch position 1: User 220 + KT</i> Number of connections allowed simultaneously

Direct Routing

A call without direct dialling is routed directly to a destination of the internal numbering plan.

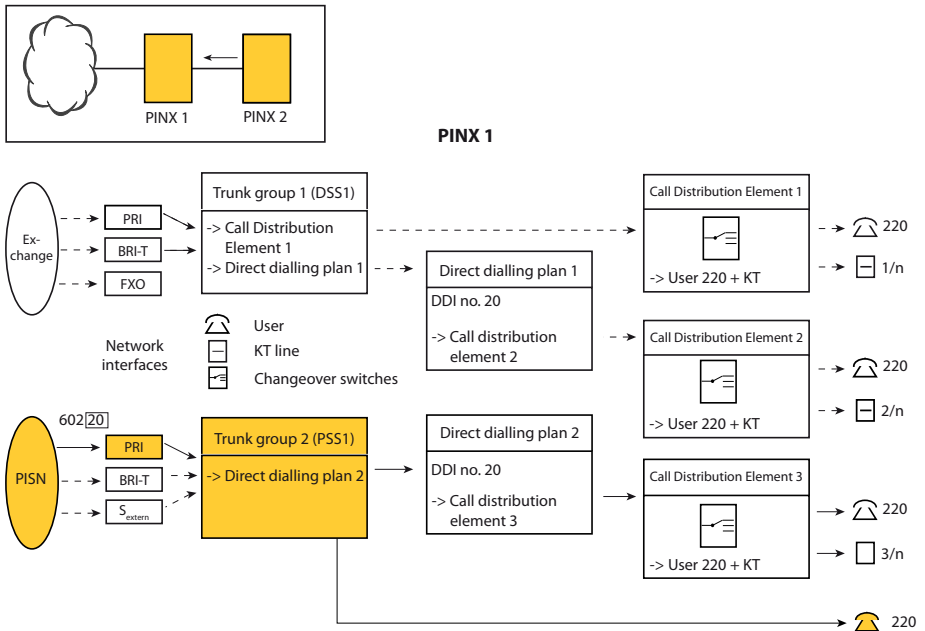

Fig. 81 Routing a call from the private leased-line network without direct dialling

Tab. 45 Setting the routing parameters

Parameter	Parameter value
Trunk group 2:	
• Network interfaces	Network interfaces in this trunk group
• Incoming connection	Number of connections allowed simultaneously
• Network type	Private
• Protocol	QSIG or QSIG / PSS1 ISO
• Overwrite NPI	no
• Direct dialling plan	2 (if a suitable DD number is found) or
• Call Distribution Element	Not relevant to this case

6.3.1.3 Personal call routing

Several terminals can be allocated to an internal user. A call to this user is routed to all the terminals allocated to him or only to a number of them (see ["One Number user concept"](#), page 337).

6.3.2 Call Forwarding Unconditional if no answer

Besides the CFNR redirecting function controllable by the user and which forwards the call after a specific number of rings (see ["Call Forwarding on No Reply \(CFNR\)"](#), page 346), there are other configuration possibilities for redirecting an unanswered call.

6.3.2.1 CDE Alternative Destinations

If at the original destination the call is neither answered nor forwarded within a configurable period of time, it can be routed to a CDE alternative destination (see ["Alternative Destination if no Answer"](#), page 125).

6.3.2.2 Default forwarding per user

Separate default forwardings can be configured for internal and external calls for each user for the cases *No answer*, *Busy* and *Rejected*. Possible redirection destinations include internal or external users, PISN users, abbreviated dialling numbers, user groups, CDE call numbers, etc. This means the default response if unobtainable can vary according to the call's origin, e.g. voice mail for internal calls and transfer for external calls.

The table below shows the interaction with other activated functions, configurations and situations when the Default Call Forwarding function is configured:

Tab. 46 Interaction of Default Call Forwarding with...

Function / Configuration / Situation	Response
CFU or CFB active	Only CFU is executed (*21 and *67 still have priority over the default call forwarding at the user.
Call Deflection (CD) activated before Default Call Forwarding	Default Call Forwarding is not executed
CFNR activated after 0, 3, 5 or 7 rings	Depends on the parameter <i>Priority over activated CFNR</i> : <ul style="list-style-type: none"> • <i>No</i>: Only CFNR is executed • <i>Yes</i>: Default Call Forwarding is always executed. (If the CNFR call forwarding delay is shorter than the internal or external delay of the Default Call Forwarding, CNFR is executed first.)
Entry under <i>CDE if no answer</i> in the CDE configuration	Depends on the times configured: If the CDE call forwarding delay in the CDE configuration is shorter than the external delay of the default call forwarding, CDE call forwarding is activated; otherwise, default call forwarding is performed.
Entry under <i>CDE if busy</i> in the CDE configuration	The CDE call forwarding when busy always has priority over the default call forwarding when busy.
User is unobtainable	If for technical reasons a user is unobtainable, the destinations configured for when the user is unobtainable are applied (see " Response if unobtainable ", page 184).
Routing the call to the user via UG	Default Call Forwarding is not executed. (Exception: Default call forwarding when busy is active and the user as well as all UG members are busy.)

Other characteristics of the Default Call Forwarding function:

- Unlike CFNR (*61), for *Default call forwarding if no answer* the terminal forwarding the call does not carry on ringing in parallel.
- The Default Call Forwarding is still executed even if no terminal is connected (Exception: A user with only one analogue terminal). Instead the destinations configured for when the user is unobtainable are applied (see "[Response if unobtainable](#)", page 184).
- The delay timer for default call forwarding is restarted after each new connection attempt.

Default Call Forwarding with calls already forwarded:

Situation: User A calls user B, who has redirected to user C. A default call forwarding to user D is configured at user C.

Tab. 47 Default Call Forwarding response to calls already forwarded

User B has ...	Standard CFU is executed
CFU Unconditional activated	Yes
CFB activated	Yes
CFNR activated	No
Call Deflection (CD) activated	Yes
Follow Me activated	No
Default Call Forwarding activated	Yes

Redirect the destination of a Default Call Forwarding

Situation: User A calls user B, where a default call forwarding to user C has been configured. User C has activated a call forwarding to D.

In this case the call forwarding from user C to user D is always executed.



Note:

Although chains of several default call forwarding are also possible, they do involve long ringing times.

System configuration

All the settings can be configured individually for each user

Tab. 48 Default Call Forwarding: System configuration

Parameter	Parameter value
<i>Internal call delay</i>	<10 to 300 seconds>
<i>Forwarding destination for internal calls if no answer</i>	<Call number>
<i>External call delay</i>	<10 to 300 seconds>
<i>Forwarding destination for external calls if no answer</i>	<Call number>
<i>Priority over activated CFNR</i>	Yes / No
<i>Forwarding destination for internal calls if busy</i>	<Call number>
<i>Forwarding destination for external calls if busy</i>	<Call number>
<i>Forwarding destination for internal calls if rejected</i>	<Call number>
<i>Forwarding destination for external calls if rejected</i>	<Call number>

6.3.3 Response if busy¹⁾

The following Chapter describes how the system responds when busy and how that response can be influenced using specific settings.

¹⁾ Does not apply to Italy

6.3.3.1 Response if the call destination is busy

If the call destination is busy, an incoming call will be handled according to the type of destination. Busy call destinations may be:

- An individual, busy user
- A busy user group
- A busy KT line
- A user with a stored message
- A user group with busy users but without the elements operator console and general bell.

Within the context of this Chapter a call destination is said to be busy if both the original destination and the alternative destinations, where configured, as busy (*CDE if busy setting*).

Call destination: Individual, busy user

Call waiting allowed but is rejected

- In the case of an incoming call from the public ISDN network the caller obtains the busy tone.
- In the case of an incoming call from the private leased-line network call waiting is not possible.
- In the case of an incoming call from the public analogue network call waiting is repeated.

Call waiting not allowed or not possible

If no alternative destinations have been configured, the following rules apply:

- In the case of an incoming call from the public ISDN network the caller obtains the busy tone.
If the caller has subscribed to the service *Automatic callback (CCBS)* with the network provider, he can activate that service.
- In the case of an incoming call from the private leased-line network the caller obtains the busy tone.
- In the case of an incoming call from the public analogue network the caller waits until the called party is free (polling).

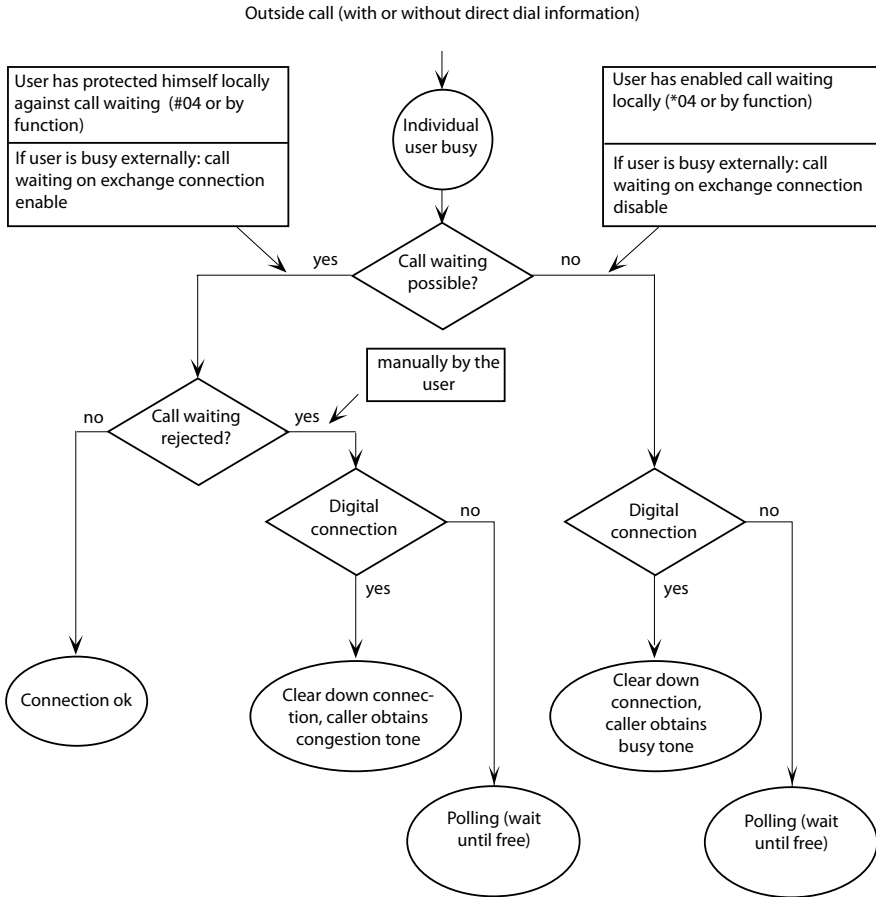

Fig. 82 Call distribution if user is busy

Call destination: Busy User Group

A user group is busy if all its members are busy, if call waiting is rejected, if call waiting is not enabled for any of the user group members and if neither the element operator console nor the element general bell is activated.

A UG with activated *Home Alone* is busy if at least one of the UG's users is in an outside call or an internal call (see "*Home alone*", page 473).

If a user group is busy, an incoming call is routed to user group 16. If user group 16 is also busy,

- the caller in the public ISDN network will obtain the congestion tone after call waiting has been rejected;
- the caller in the private leased-line network will obtain the congestion tone.
- a call from the public analogue network will wait until the user is free after call waiting has been rejected.

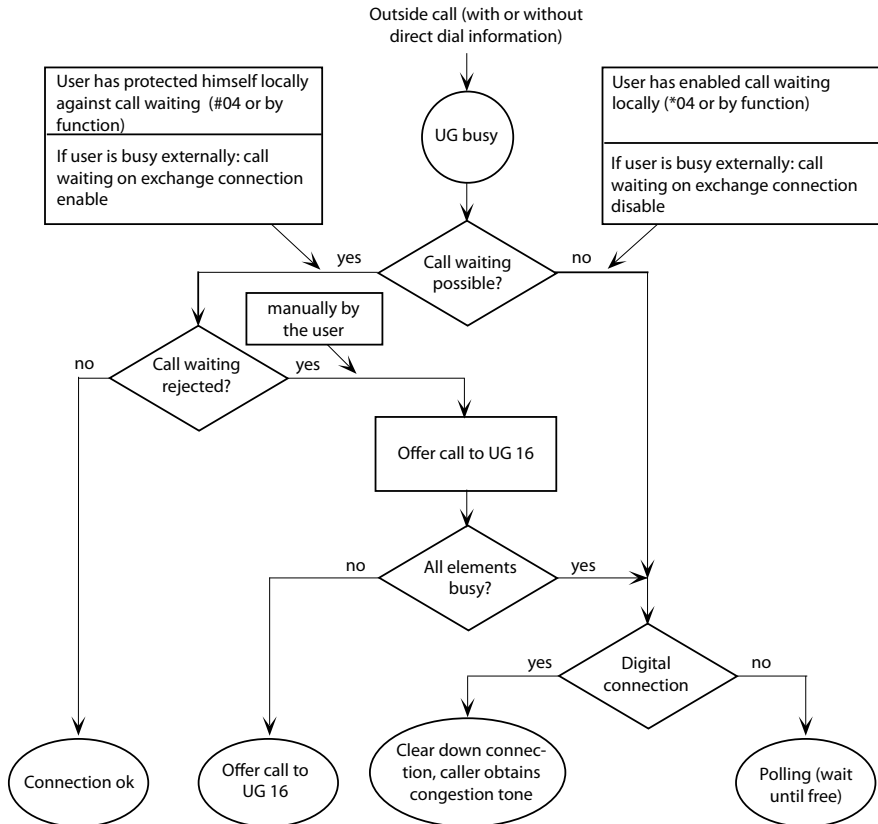

Fig. 83 Call distribution if user group busy

Call destination: Busy KT Line

If an incoming call is routed to a busy KT line, the call will be rejected and the caller obtains the busy tone.

Call destination: User with a Stored Message

If a user has stored a message, an incoming call will be routed to the preconfigured Call Forwarding Unconditional destination.

If a preconfigured Call Forwarding Unconditional destination has not been defined, the user will be called nonetheless.

6.3.3.2 Forwarding a call if busy

To ensure that each incoming call is answered, the following configuration recommendations must be observed:

Configuration for Users and Terminating KT Lines

- Configure Call Forwarding on No Reply if busy and preconfigured Call Forwarding on No Reply.
The call is diverted to a preconfigured call forwarding destination if the user is busy.
- Configure preconfigured Call Forwarding Unconditional.
The call will be routed to a preconfigured Call Forwarding Unconditional destination in the case of a stored message or Call Forwarding Unconditional to standard text.
- Activate permanent Call Forwarding on No Reply.
If the user does not answer, a delayed call is made to the CFNR destination.

Configuration for user groups

Enter elements with call queues in the user group (operator console or general bell).

Configuration of the call distribution elements

Configure alternative destinations if busy (*CDE if busy* setting).

Configuration for through KT lines

- In the call distribution configure *KT line and user group* as the destination.
- Delay the elements of the user group.

The user group is therefore an additional distributor if all the addressed through KT lines are busy..

Using a Voice Mail System

Unanswered calls can also be forwarded to a voice mail system where they are processed (see "User Groups for Voice Mail and Other Applications", page 140).

6.3.3.3 Not Forwarding a Call if busy

If the caller is to obtain the busy tone when the user is busy, the following configuration recommendations must be observed:

- Do not configure an alternative destination if busy (leave the *CDE if busy* setting blank).
- Do not configure Call Forwarding on No Reply if busy
- Disable call waiting on exchange connections in the system configuration
- Disable local call waiting using *04



Note:

Disable *Call waiting* if a fax machine is connected to an internal terminal interface.

6.3.3.4 Release Destination if Incoming Dialling is Incomplete¹⁾

If the direct dial number is incompletely dialled the outside call will be routed to the call distribution element allocated to the trunk group after 8 to 15 seconds (depending on the country) and then forwarded to the destinations entered there.

¹⁾ Only in countries in which digit-by-digit DDI is implemented in their public exchanges.

6.3.4 Response if unobtainable

Various redirection destinations can be configured for each user so that ideally no calls are left to idle for whatever technical reasons. The call is then redirected depending on why the terminal is unobtainable and the call's origin (internal/external). A user is considered to be unobtainable only if none of his allocated terminals can be reached. Possible redirection destinations include internal and external users, PISN users, abbreviated dialling numbers, user groups, call distribution elements, etc.

There are three categories of reasons why a terminal may be unobtainable:

Category 1: **Terminal not running or out of DECT coverage range**

- A desk phone is not connected
- A cordless phone
 - is outside the coverage range
 - is switched off or its battery is empty
 - is not logged on
- A softphone (IP terminal) is not started up or not connected to the IP network



Note:

Analogue terminals that are not connected cannot be detected.

Examples of sensible redirection destinations:
user's voice mailbox, switching centre.

Category 2: **No VoIP channel available at present**

An IP terminal or a user on a different node in an AIN cannot be reached momentarily because

- the configured bandwidth between the nodes in accordance with the bandwidth model is being used to capacity.
- all VoIP channels of the DSP chips are occupied.
- the licence limit for the number of simultaneously active VoIP channels has been reached.

Examples of sensible redirection destinations:
User's external call number, user's mobile number, general voice mailbox, switching centre.

**Note:**

If PSTN overflow is enabled and configured in the AIN, an attempt will first be made to route the call via the PSTN.

Category 3: *Satellite in offline mode or terminal port inactive*

- The required user is on a satellite that is currently in offline mode.
- An originally configured terminal port is inactive because an interface card is not fitted or because of a hardware fault.

Examples of sensible redirection destinations:

User's external call number (if the satellite also has access to the public network), user's mobile number, general voice mailbox, switching centre.

**Note:**

If the required user is technically obtainable but the call is not answered, two redirection destinations can be also be configured for internal and external calls (see "Default forwarding per user", page 176).

Other properties of redirection destinations when unobtainable

- If the caller is forwarded to a destination that is also unobtainable, he obtains the busy tone.
- If the redirection destination is busy, the caller obtains the busy tone.
- If a forwarding to the originally dialled user has been configured at the redirection destination (thereby creating a loop), the forwarding is not carried out and the terminal at the first redirection destination rings instead.
- If an external caller is forwarded to an external destination, the settings for enabling exchange-to-exchange traffic need to be observed.
- If the user of IP terminal cannot reach the user he has dialled because there are no VoIP capacities available on his side, the redirection destinations for unobtainable are not applied.
- A call to a user who is redirected to a destination if unobtainable always triggers an entry in the user's unanswered call list, even if the call is answered at the redirection destination.

6.3.5 Emergency Routing¹⁾

6.3.5.1 Routing if the Call Destination is busy

If the call destination is busy, an incoming call will be handled according to the type of destination. Busy call destinations may be:

- an individual, busy user
- a busy user group
- a busy KT line
- a user with a stored message

Call destination: Individual, busy user

Call waiting is allowed, but is rejected

Tab. 49 Call waiting is allowed, but is rejected

Origin of the call	Response if the Capolinea destination ...	
	... is defined	... is not defined
Call from the public ISDN network	Call is routed to the defined Capolinea destination	Call is cleared down, caller obtains busy tone
Call from the public analogue network	Call is routed to the defined Capolinea destination	Wait until free, caller obtains ring-back tone

Call waiting is not allowed

Tab. 50 In the call distribution "CDE if busy" is set on Capolinea

Origin of the call	Response if the Capolinea destination ...	
	... is defined	... is not defined
Call from the public ISDN network	Call is routed to the defined Capolinea destination	Call is cleared down, caller obtains busy tone
Call from the public analogue network	Call is routed to the defined Capolinea destination	Wait until free, caller obtains ring-back tone



Note:

If a fax machine is connected to an internal terminal interface, disable *Call waiting* for that user.

¹⁾ For Italy only

Call destination: Busy User Group

A user group is busy if all its members are busy, if call waiting is rejected, if call waiting is not enabled for any of the user group members and if neither the element operator console nor the element general bell is activated.

If a user group is busy, an incoming call is routed to user group 16.

If Call waiting is not enabled for any of the members of user group 16, the caller is obtains busy tone.

Call destination: Busy KT Line

If an incoming call is routed to a busy KT line, the call will be rejected and the caller obtains the busy tone.

Call destination: User with a Stored Message

If a user has stored a message, an incoming call will be routed to the preconfigured Call Forwarding Unconditional destination.

If a preconfigured Call Forwarding Unconditional destination has not been defined, the user will be called nonetheless.

6.3.5.2 Release Destination if Dialling is Incomplete

If the direct dial number is incompletely dialled, the outside call will be routed to the call destination element allocated to the trunk group after 8 seconds and then forwarded to the destinations entered there.

Scope

Valid only if the network provider transmits the digits of the direct dial numbers using the overlap receiving method. If the direct dial numbers are transmitted using the en-bloc method, an incomplete direct dial number will never be transmitted to the communication server.



Aastra Intelligent Net:

In an AIN the availability of Capolinea depends on the Master settings. If the *Country* parameter is configured to *IT* on the Master, Capolinea is available throughout the AIN.

6.4 Automatic reject of collect calls¹⁾

The public network in Brazil offers the possibility of collect calls. A collect call is a call in which the called party accepts the costs of the call. The called party normally has a few seconds to reject the collect call before he incurs costs. This decision cannot be made if the call goes to a fax or automatic answering machine; thus, high, unwanted costs may be incurred. To prevent misuse, the system can detect and reject collect calls automatically.

Detection of collect calls

Detection of collect calls depends on which network interface the call comes through:

Tab. 51 Detection of collect calls

Origin of the call	Detection
Call from the public ISDN network	The call is identified as a collect call and can be handled accordingly.
Call from the public analogue network	The call is not identifiable as a collect call and is routed in accordance with normal routing. Only after call seizing can collect calls be distinguished from normal calls with a loop-break (see the section below).
Call comes via a SIP provider	The call is not identifiable as a collect call.

Detection of collect calls on analogue network interfaces

A loop-break shortly after seizing (double answer) causes the collect call to be terminated in the public exchange; normal calls, however, can be continued as usual. For this purpose, the following parameters are configurable for the AIN regions (CM_1_2_11):

Tab. 52 Detection of collect calls on analogue network interfaces

Parameter	Meaning
<i>Loop interruption</i>	Duration of the loop-break in milliseconds.
<i>Pause</i>	Duration in milliseconds between seizing the line and the loop-break.

Handling of collect calls

The handling of collect calls can be configured with various parameters per trunk group, per user group, and per user:

¹⁾ For the Brazilian sales channel only

Tab. 53 Handling collect calls: Trunk group configuration

Parameter	Meaning
<i>Handling of collect calls</i> <ul style="list-style-type: none"> • Reject all collect calls • Allow all collect calls • <i>Depends on destination</i> 	Trunk group configuration All collect calls are rejected. Collect calls are handled as normal calls. The user can manually reject a collect call by hanging up. The configuration of the user's permission set or the user group is decisive.

**Note:**

When incoming calls arrive via SIP network interfaces, collect calls and normal calls cannot be differentiated. This is why with the setting *Reject all collect calls* both collect calls and normal calls are rejected.

For the trunk group setting *Depends on the destination*, the following responses apply:

- The call arrives at a user:
All collect calls are rejected if the parameter *Allow collect calls* is configured to *No* in the user's assigned permission set.
- The call arrives at a system destination which automatically answers the call (e.g. voice mail system):
All collect calls are rejected.
- For calls from the public ISDN network, the following also applies:
 - All collect calls are rejected if the call arrives at a user group whose parameter *Offer collect calls* is configured to *No*.
If the parameter *Offer collect calls* is configured to *Yes*, collect calls are offered to those user group members whose permission set has the parameter *Allow collect calls* configured to *Yes*.
 - The call goes to an external destination (e.g. via forwarding or if the call is to a PISN user):
The external destinations are not called.

**Note:**

When incoming calls arrive via SIP network interfaces, collect calls and normal calls cannot be differentiated. All calls are handled like collect calls from the public ISDN network.

6.5 Outgoing traffic

All outgoing calls are routed to a network via a route. The authorization to make outgoing calls can be specified for each user (page 201). Digit barring facilities can also be used to regulate dialling access on the basis of the numbers dialled (page 191). The feature "Priority exchange allocation" can be used to give priority to a user wishing to set up an outgoing call (page 202). The LCR (Least Cost Routing) function is used to control automatically the path (in the communication server and in the network) via which an outgoing call is to be routed (page 206).

6.5.1 Routing

All outgoing calls are routed to a trunk group via a route. They include calls routed via the Least Cost Routing function or transit calls in a PISN. Different types of call destinations have to be routed via different routes. For example calls to the private leased-line network must not be routed via the same routes as calls to the public network.

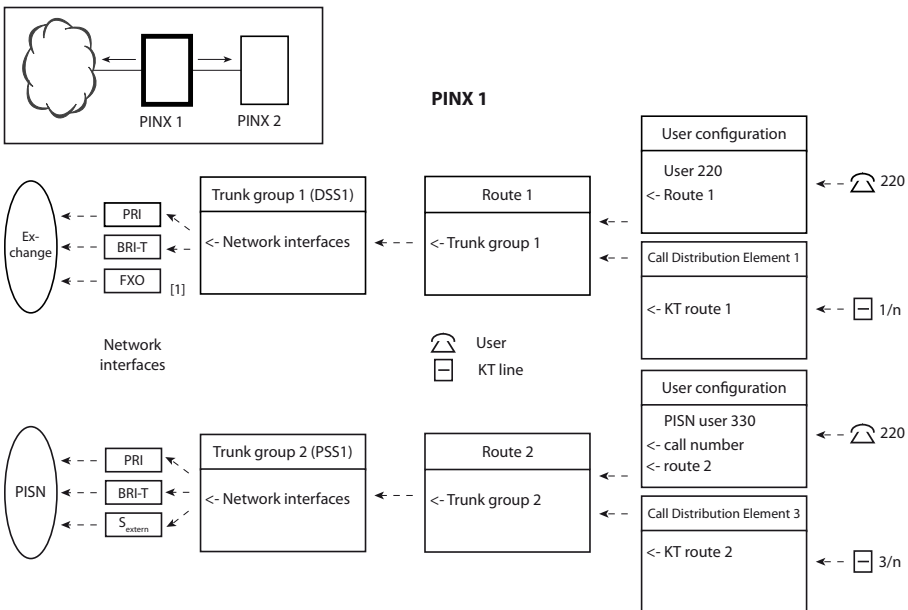

[1] One and the same trunk group cannot contain both analogue and digital network interfaces.

Fig. 84 Routing outgoing calls

6.5.2 Digit barring

Digit barring facilities are user-definable filters used for regulating exchange access authorization based on the numbers dialed. Several digit barring facilities are available in each case for internal and outgoing traffic (internal and external digit barring facilities).

Difference between Internal and external Digit Barring:

- Internal digit barring filters internal phone numbers:
Numbers that are entered in the internal numbering plan.
- External digit barring filters external phone numbers:
Numbers that are sent into the network.

Allocating Digit Barring:

- Each user can be allocated internal and external digit barring for all three switch positions.
- External remote control can be allocated an internal digit barring to restrict the features that can be remote controlled..
- The lock function on the phone lock variants activates an internal and an external digit barring.
- Digit barring facilities cannot be allocated to a PISN user.

Bypassing the digit barring

Digit barring facilities are bypassed in the following cases:

- Deactivation of the external digit barring allocated to the user in the route configuration
Example:
The digit barring is deactivated in the route configuration for route 1 and activated in the route configuration for route 2.
If a user with an allocated external digit barring sets up a call via route 1, the digit barring will not be consulted; if he sets up the call via route 2, the digit barring will be consulted.
- Calls via analogue network interfaces that are set to *Behind communication server*.
- Stored phone numbers of PISN users
- Stored phone numbers of integrated mobile phone users

- Stored phone numbers of emergency and abbreviated dialling numbers, provided the emergency or abbreviated dialling number is dialled.
- Stored phone numbers of abbreviated dialling numbers, provided they are dialled using dialling-by-name.
- The digit barring for external remote control cannot be bypassed. (This applies only to internal users on their own communication server but not to PISN users in a QSIG network.)

**Note:**

If a function code used for operating a feature is stored under an abbreviated dialling number, make sure the abbreviated dialling number is barred in the digit barring for unauthorized internal users and that no name is assigned to the abbreviated dialling number. In a QSIG network this applies in particular to all PINXs that have entered the abbreviated dialling number as PISN users in the numbering plan.

Setting up the digit barring

In a digit barring everything can in principle be enabled (*Basic function = enable all*) or barred (*Basic function = bar all*).

Exceptions to the basic setup are entered in an enabled list or in a barring list.

Digit sequences that are not on the enabled or barring list are either enabled or barred, depending on the basic setup.

A phone number is compared from left to right with the digit sequence of the allocated digit barring.

Example:

- *Basic function = enable all*
- Digit "6" is entered in the barring list. This digit barring restricts all phone numbers that begin with 6.
- The digit sequence "62" is entered in the barring list. This digit barring only restricts phone numbers that begin with 62.
- The digit sequence "6" is entered in the barring list and the digit sequence "63" in the enabled list. This digit barring restricts all phone numbers that begin with 6, except those that begin with 63.

Number of character strings

Up to 10 character strings can be entered per list.
 A character string can consist of up to 20 characters.

Type of characters

Digits: 0, 1 to 9
 Characters: *, #, A, B, C, D
 Control key, Flash: R

Nesting entries in the enabled and barred lists

Exceptions to a digit sequence barred in the barring list are entered in the enabled list and vice versa. In the example on the left in Fig. 85 all phone numbers that begin with the digit sequence "00" are barred except those that begin with "003" or "004". This nesting depth is permitted.

The entry in the example on the right bars all phone numbers that begin with the digit sequence "00" except those that begin with "003" but not with "0031". This nesting depth is not admissible. The entry "0031" is ignored by the system.

<input type="checkbox"/> all disable (s)		<input type="checkbox"/> all disable (s)	
<input checked="" type="checkbox"/> all enable (f)		<input checked="" type="checkbox"/> all enable (f)	
F1 003	S1 00	F1 003	S1 00
F2 004	S2	F2	S2 0031 not allowed
F3	S3	F3	S3
F4	S4	F4	S4
F5	S5	F5	S5

✓
✗

Fig. 85 Only one degree of nesting is permitted

Examples of digit barring facilities

A user or user group may only dial the following external destinations:

- Destinations within their own network group
- Destinations of network group 031 and 033
- Destinations in Germany (0049)

The following restrictions also apply:

- No external connections through cost centre selection
- No external connections through route selection

These two restrictions are regulated using the internal barred-code; the others, using the external digit barring:

<input type="checkbox"/> all disable (s)	
<input checked="" type="checkbox"/> all enable (f)	
F1 031	S1 0
F2 033	S2
F3 0049	S3
F4	S4
F5	S5

External digit barring

<input type="checkbox"/> all disable (s)	
<input checked="" type="checkbox"/> all enable (f)	
F1	S1*78
F2	S2 13
F3	S3 17
F4	S4
F5	S5

Internal digit barring

Fig. 86 Example of digit barring facilities

In this example the exchange access prefixes are entered as follows in the numbering plan:

- Exchange access for cost-centre selection: 13
- Exchange access for route selection: 17x

Function code *78 is used to allocate a cost centre using suffix dialling. That is why the digit sequence *78 is also barred.

Default settings

After an initialization a number of digit barring options already have pre-entered digit sequences. They can vary from country to country.

Examples of digit barring initialization values:

- External digit barring 1:
Internal: All barred except service and emergency numbers.
- External digit barring 2:
Local: All barred except service and emergency numbers and calls within your own network group.
- External digit barring 3:
Only domestic calls permitted.
- External digit barring 4:
Only calls within Europe permitted.
- External digit barring 5:
All enabled except */# features on the exchange.

- Internal digit barring 1 to 5: Remote control (*06) of */# function codes and setting of the system time and system date (*57, *58) barred.
- Internal digit barring 8 (2025/2045) and 16(2065): Remote control external barred (ERC *75, *85).



Aastra Intelligent Net:

In an AIN the digit barring settings apply to the entire network. The default values depend on the Master's sales channel and not on the country that is configured in the corresponding AIN region.

6.5.3 Call to the Public Network

Access to the public network can be obtained with a variety of dialling types:

- Dialling an exchange access prefix
- Dialling an abbreviated dialling number (see [page 196](#))
- Dialling the emergency number (see [page 196](#))
- Dialling via a line key on a key telephone (see [page 198](#))
- Dialling via a line key on a operator console (see [page 200](#))
- Dialling the phone number of a virtual network PISN user (see [page 200](#))

Dialling an exchange access prefix

The allocation of prefixes to access types is set out in the numbering plan, where the prefixes can be configured (see "[Numbering Plan Identifiers](#)", [page 43](#)). Exchange access prefixes are used to dial the following access types:

- *Exchange access business:*
The call is routed via the route configured for the user.
The call charges are logged under Business on the user counter (among others) (for more information on call charge allocation see "[Individual charge counting or ICC](#)", [page 263](#)).
- *Exchange access private:*
The call is routed via the route configured for the user.
The call charges are logged under Private on the user counter (among others).
- *Cost centre selection:*
The call is routed via the route configured for the user.

The call charges are logged (among others) on the counter for the selected cost centre.

- **Route selection:**

The call is routed via the route selected by means of a prefix.

The call charges are logged under Business on the user counter (among others).

Dialling an abbreviated dialling Number

With an abbreviated dialling number dials the stored phone number. The phone number must have an exchange access prefix.

The digit barring facilities are bypassed. If the call destination for an abbreviated dialling is to be barred using digit barring, the abbreviated dialling number must be entered in the internal digit barring.

The call is routed via the user's route, provided the stored phone number does not already have a prefix for exchange access with route selection.

The call charges are logged in accordance with the user configuration, provided the stored number does not already have an exchange access prefix that regulates call charge logging (e.g. *Exchange access, Private*).

A name can be stored with each abbreviated dialling number, thereby also enabling name dialling.



Aastra Intelligent Net:

In an AIN with nodes in different countries the abbreviated dialling numbers must always include the international prefix (e.g. "00") and the country code (e.g. 41).

(example: 0-0041326553333). This is necessary as the national portion of the number may well be identical in different countries. This prevents conflicts in the call routing and call number display (CLIP).

Dialling the emergency number

Depending on the switch group and switch position, the emergency number dials one of the three stored phone numbers. The phone numbers must have an exchange access prefix.

The external digit barring is bypassed.

The call is routed via the user's route, provided the stored phone number does not already have a prefix for exchange access with route selection.

The call charges are logged in accordance with the user configuration, provided the stored number does not already have an exchange access prefix that regulates call charge logging (e.g. *Exchange access, Private*).

Dialling from SIP terminal

For SIP terminals, the international number format beginning with the "+" sign is supported (canonical number). The communication server changes the "+" to a "0" (*Exchange access business*). The external call number may also contain the following characters: "+", "/", "(", ")", and "blank". These signs are filtered out by the communication server before dialling. If a call number contains the country code as well as the national prefix, the national prefix can also be automatically filtered out (see "Dialling internal destinations via external call numbers", page 164).

Dialling an external number assigned to an internal destination

If an external call number is assigned to an internal destination, the outgoing call will be routed to the internal destination under certain conditions (see "Dialling internal destinations via external call numbers", page 164).

6.5.3.1 Routing the call

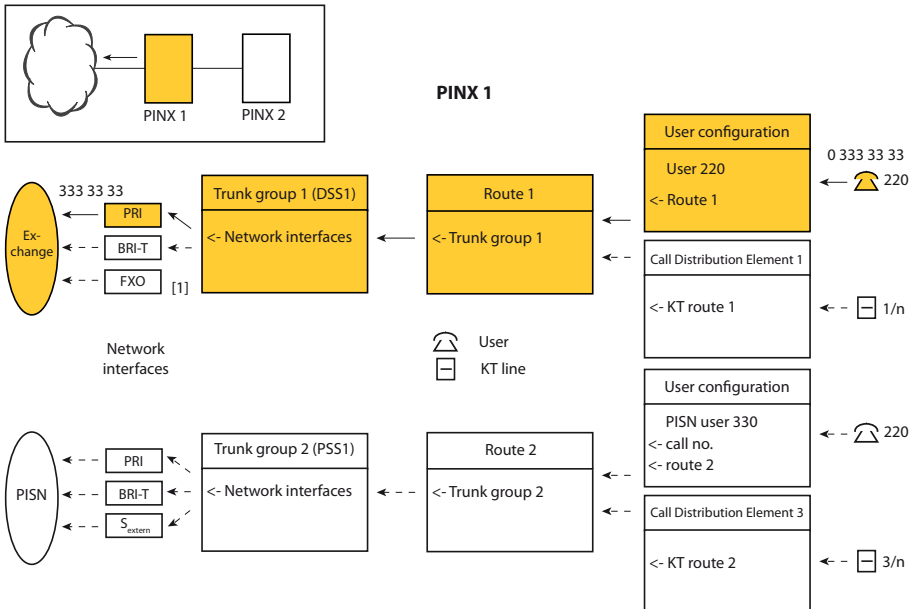

[1] One and the same trunk group cannot contain both analogue and digital network interfaces.

Fig. 87 Routing a call to the public network

Tab. 54 Setting the routing parameters

Parameter	Parameter value
User configuration BN 220: <ul style="list-style-type: none"> • <i>Route</i> • <i>External digit barring</i> 	1 (route reference number) One digit barring each for switching position 1, 2 and 3
Route 1: <ul style="list-style-type: none"> • <i>Trunk groups</i> • <i>Outgoing connections</i> • <i>Digit barring</i> • <i>Numbering plan identifier NPI</i> 	1 (reference number of one or more trunk group(s)) Number of connections allowed simultaneously Yes (poll digit barring) E.164
Trunk group 1: <ul style="list-style-type: none"> • <i>Network interfaces</i> • <i>Network type</i> • <i>Protocol</i> 	Network interfaces of this trunk group <i>Public</i> ¹⁾ <i>DSS1</i> ¹⁾

¹⁾ Not relevant for trunk groups with analogue network interfaces

6. 5. 3. 2 Call to the public Network via a Key Telephone

Dialling via a line key on a key telephone routes the call via the allocated KT route. The KT route is entered in the call distribution element of the KT line.

The call charges can be logged (among others) at the KT cost centre. The KT cost centre is entered in the call distribution element of the KT line (for more information on call charge allocation see [page 263](#)).

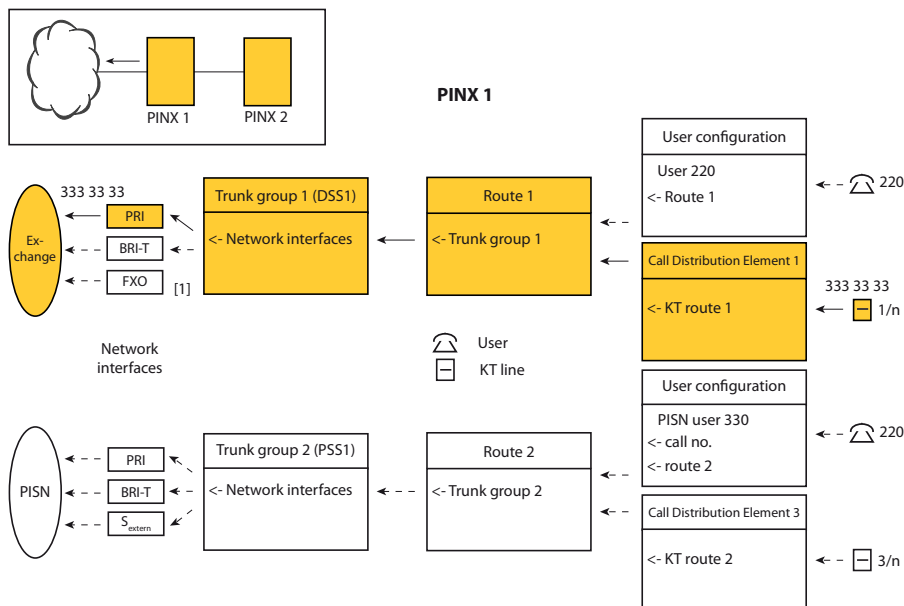

[1] One and the same trunk group cannot contain both analogue and digital network interfaces.

Fig. 88 Routing a call to the public network via a line key of a key telephone

Tab. 55 Setting the routing parameters

Parameter	Parameter value
Call distribution element 1: • <i>KT route</i>	1 (route reference number)
Route 1: • <i>Trunk groups</i> • <i>Outgoing connections</i> • <i>Digit barring</i> • <i>Numbering plan identifier NPI</i>	1 (reference number of one or more trunk group(s)) Number of connections allowed simultaneously Yes (poll digit barring) E.164
Trunk group 1 • <i>Network interfaces</i> • <i>Network type</i> • <i>Protocol</i>	Network interfaces of this trunk group Public ¹⁾ DSS1 ¹⁾

¹⁾ Not relevant for trunk groups with analogue network interfaces

6. 5. 3. 3 Call to the public Network via an operator console

Dialling via a line key of Company A routes the call via Route 1.
 Dialling via a line key of Company B routes the call via Route 2.

6. 5. 3. 4 Call to a virtual Network PISN User

The virtual network PISN user is integrated into the PISN via the public network. The call to a virtual network PISN user is therefore routed via the public network.

The PISN user must be created in the internal numbering plan. The caller dials the PISN user number.

The routing information on the PISN users is allocated to the user configuration and includes the route to be used and the phone number under which the destination user can actually be reached (the phone number is indicated without exchange access prefix). In the following example the PISN user with phone number 440 can be reached in the public network under phone number 333 33 40.

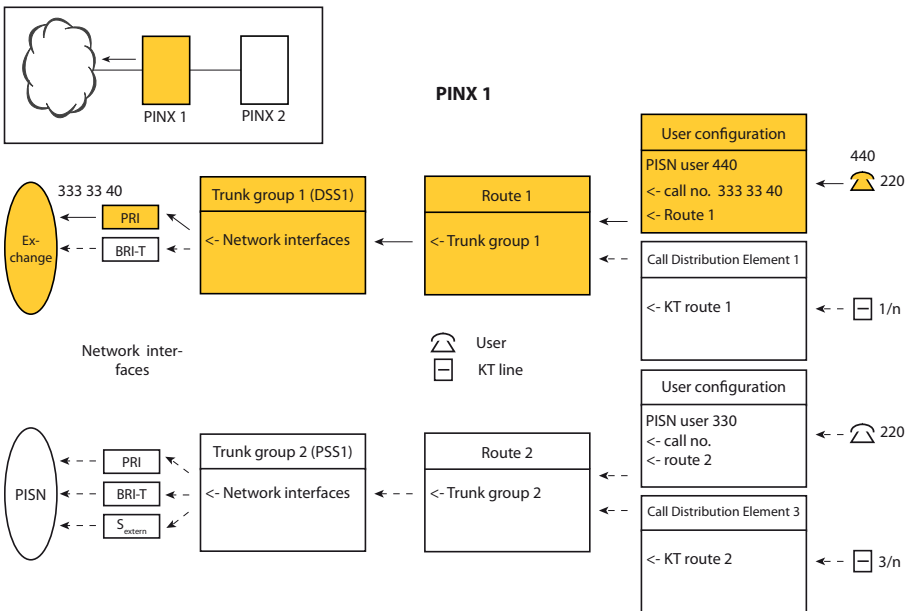

Fig. 89 Routing a call to a virtual network PISN user via the public network

Tab. 56 Setting the routing parameters

Parameter	Parameter value
User configuration PISN-BN 440: <ul style="list-style-type: none"> • <i>Route</i> • <i>Number</i> 	1 (route reference number) 333 33 40 (phone number to be dialed, without exchange access prefix)
Route 1 <ul style="list-style-type: none"> • <i>Trunk groups</i> • <i>Digit barring</i> • <i>Numbering plan identifier NPI</i> 	1 (reference number of one or more trunk group(s)) Yes (poll digit barring) E.164
Trunk group 1: <ul style="list-style-type: none"> • <i>Network interfaces</i> • <i>Network type</i> • <i>Protocol</i> 	Network interfaces of this trunk group <i>Public</i> <i>DSS1</i>

6.5.3.5 Exchange access

The outgoing authorization to telephone into the public network is defined with the parameter *Exchange access* in a permission set. The permission set is then assigned to a user.

This setting does not bar dialling into the public network with abbreviated dialling and emergency numbers (see "[Bypassing the digit barring](#)", page 191).



Note:

If the call type for hotel applications is configured to *Room*, *Exchange access* can also be set in the user settings. To enable a hotel guest to make external calls, *Exchange access* must be allowed in the assigned permission set as well as in the user settings.

6. 5. 3. 6 Priority exchange allocation

This feature gives individual users preferential treatment when they set up outgoing connections. If a user with priority exchange allocation sets up a connection and all the B channels of the selected route to the network are busy, one of the B channels will be cleared down and made available to the user (user configuration setting: *External priority = emergency*).

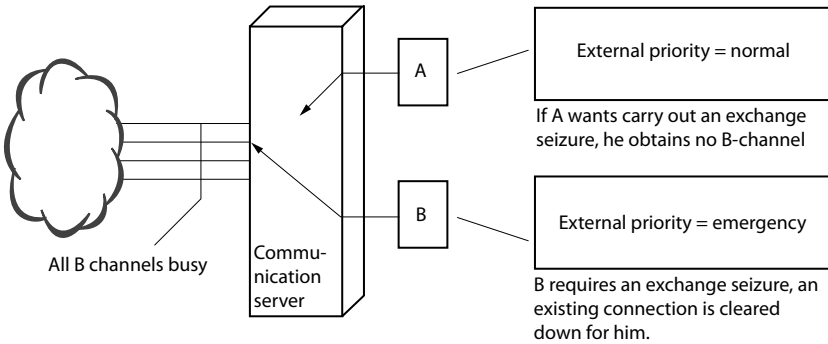

Fig. 90 Network access rights for users with and without Priority exchange allocation



Aastra Intelligent Net:

In an AIN, priority exchange allocation can only be guaranteed on the local exchange interfaces, not across the entire network.

Example

In the event of an alarm, an alarm system independent of the communication server transmits a message to an alarm headquarters via an ISDN card on an S terminal interface (e.g. a text or a file).

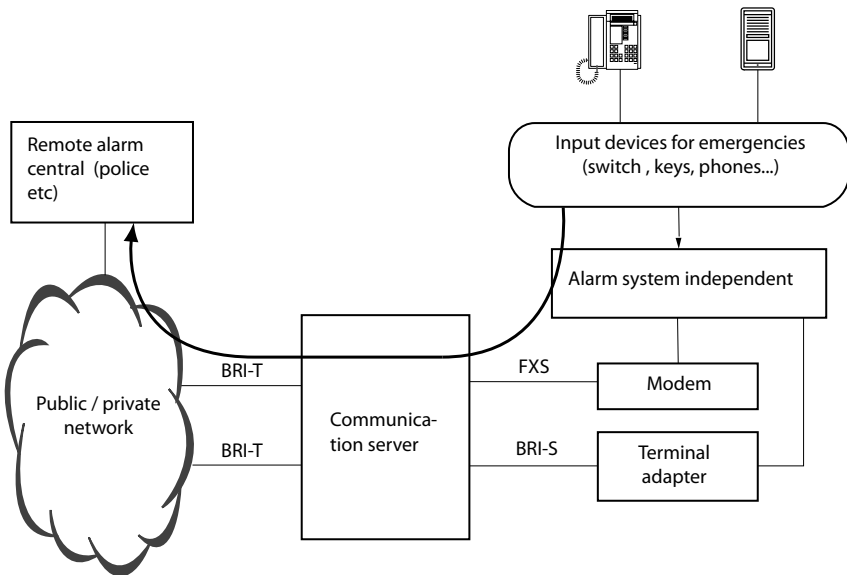

Fig. 91 Overview of a configuration for emergency applications

Scope

The priority setting is activated only in the case of direct dialling, not however in the case of call forwarding, CFNR etc

In a private network the prioritization of an outgoing connection is only possible on the communication server connected to the public network (gateway PINX).

In principle all internal users can be defined with *External priority = emergency*, even if there are fewer B channels to the public network than authorized users.

Connections seized by users who also have priority will not be cleared down.



Note:

Network interfaces used for external priority calls must be connected with the public network and active. It is advisable to provide a specific network interface for this purpose and to check it on a regular basis. Connections to the public network via analogue network interfaces cannot be cleared down.

Default setting

On initialization all users are defined with *External priority = emergency*.

6.5.4 Call to the private Leased-Line Network

The call to a fixed network PISN user is routed via the private leased-line network. The PISN user must be created in the internal numbering plan. The caller dials the PISN user number.

The routing information on the PISN users is allocated to the user configuration and includes the route to be used and the phone number under which the destination user can actually be reached.

Normally a PISN user in the fixed network can be reached directly under his PISN phone number, which means that no other phone number needs to be entered in the user configuration.

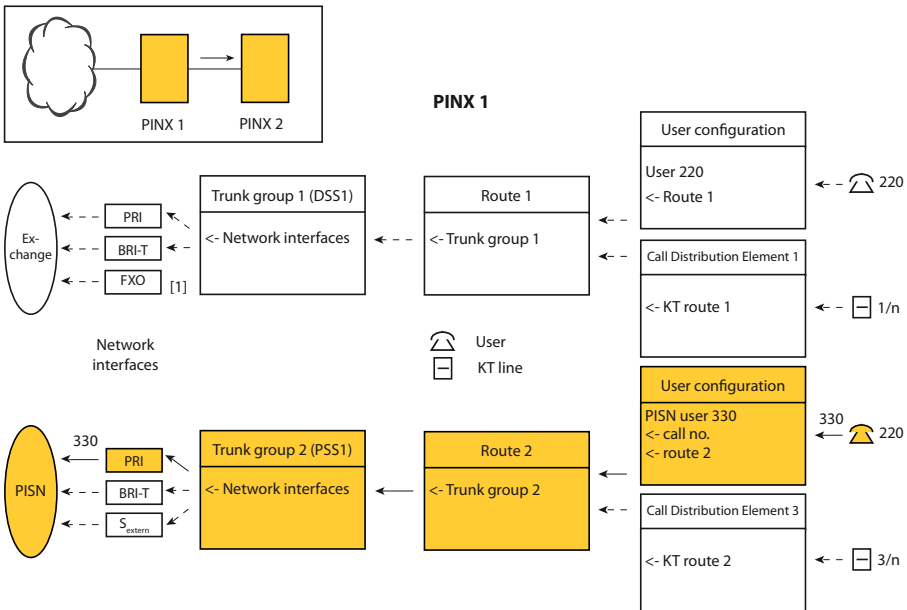

Fig. 92 Routing a call to the private leased-line network

Tab. 57 Setting the routing parameters

Parameter	Parameter value
User configuration PISN-BN 330:	(PISN user)
• <i>Route</i>	2 (route reference number)
• <i>Number</i>	Not relevant in this case
Route 2:	
• <i>Trunk groups</i>	2 (reference number of one or more trunk group(s))

Parameter	Parameter value
<ul style="list-style-type: none"> Digit barring Numbering plan identifier NPI 	No (do not poll digit barring) PNP
Trunk group 2 <ul style="list-style-type: none"> Network interfaces Network type Protocol 	Network interfaces of this trunk group Private QSIG or QSIG / PSS1 ISO

6.5.5 Call to a DSS1 Terminal equipment on the S Bus (DDO)

The BRI-S external interface can be used to address a terminal equipment that has its own direct dialling plan. The system dials the terminal's end destinations using DDI numbers, which is equivalent to a DDO (direct dialling out) function. A fax server is an example of one such terminal.

A PISN user is created in the communication server for each outgoing direct dialling number.

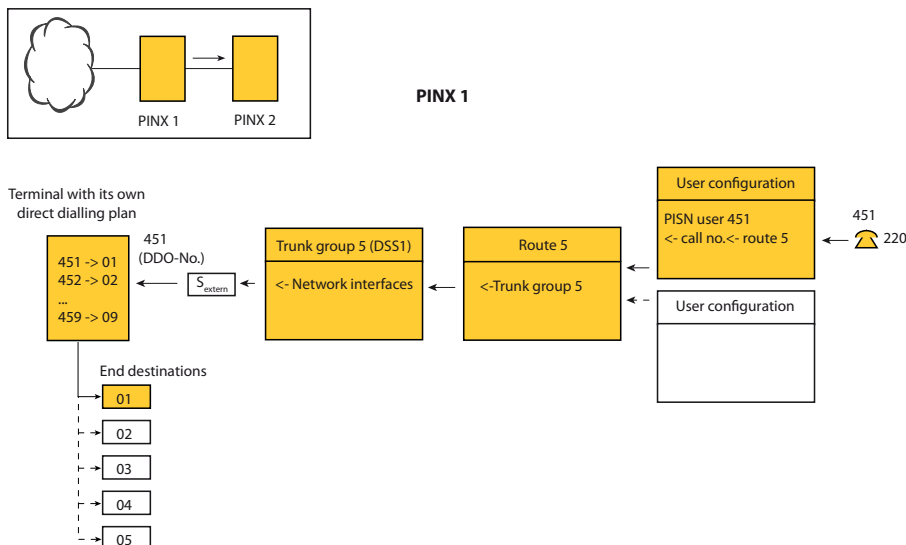

Fig. 93 Call to a terminal with its own direct dialling plan

The following services are supported on BRI-S external :

- Base Call

- CLIP / CNIP
- Call charge information

Tab. 58 Setting the routing parameters

Parameter	Parameter value
User configuration PISN-BN 451: <ul style="list-style-type: none"> • <i>Route</i> • <i>Number</i> • <i>Numbering plan identifier NPI</i> 	5 (route reference number) – E.164
Route 5: <ul style="list-style-type: none"> • <i>Trunk groups</i> • <i>Digit barring</i> 	5 (separate trunk group with BRI-S external for DDO application) Use or do not use digit barring
Trunk group 5: <ul style="list-style-type: none"> • <i>Network interfaces</i> • <i>Network type</i> • <i>Protocol</i> 	Interface <i>BRI-S external</i> <i>Private</i> <i>DSS1</i>

Terminals with a separate direct dialling plan down circuit from an Aastra 400 communication server can also be addressed from the public or private leased-line. From a routing technology viewpoint this corresponds to the situation "Routing a call from the public / private network to the PISN" (see also the descriptions as of [page 238](#)).

An BRI-S external interface (P-P or P-MP) can be used as the network interface. The call charges are transmitted in ETSI format

6.6 Least Cost Routing (LCR)

Nowadays users usually have several service providers at their disposal to rely on for routing their calls. To ensure that calls are routed as cost effectively as possible, it make sense to select the service provider according to the call destination (e.g. to use a different service provider for long-distance calls compared with local calls).

A service provider will either have his own network or a licence agreement with another network provider. A private leased-line network as defined for the LCR function is a service provider with special characteristics.

In this chapter the term network provider will be used for both network providers and service providers.

6.6.1 Direct or indirect Selection of the Network Provider

The network provider can be selected either manually for each call or automatically using the LCR function.

The network of the required network provider can be reached directly or indirectly from the communication server.

Direct Network Access

The communication server is directly connected with several networks operated by different network providers.

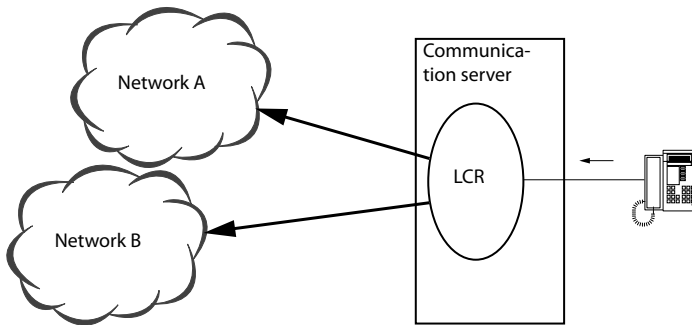

Fig. 94 Direct access to network A or B using LCR

Indirect Network Access

The communication server is connected to a specific network (network A). The destination network (network B) is reached indirectly via this network. This case occurs frequently.

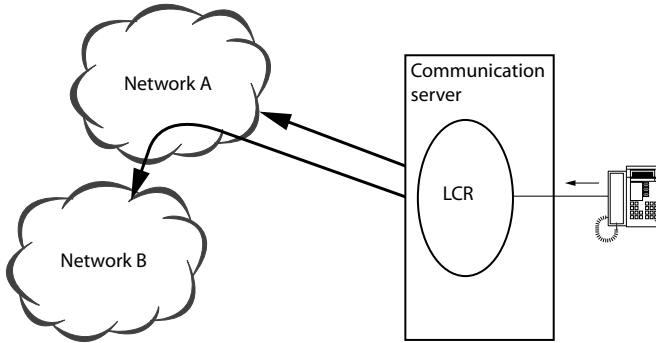

Fig. 95 Indirect access to network B via network A using LCR

For indirect access the phone number dialled must contain the following information:

- Call number of the destination user.
- Network provider required (in the example network provider B).
- The code information (in the example for network provider B) used by B to check whether the caller is a subscriber to his network.

Network provider A can respond to the call in the following way:

- He either routes the destination number on directly using his own numbering plan.
- He takes the call and waits for code information, such as the destination number, to be transmitted by the caller in DTMF mode.

6. 6. 2 LCR function

To be able to make outgoing phone calls, an internal user normally dials an exchange access prefix first.

If the LCR function is deactivated the communication server routes the call in accordance with the exchange access prefix dialled (see "[Exchange access](#)", page 201).

If the LCR function is activated and able to analyse the phone number dialled, the phone number will be routed in accordance with the configured LCR criteria. The exchange access prefix is not analysed by the LCR function.

The LCR function can be activated or deactivated throughout the system. If it is activated, it can be deactivated for individual users.

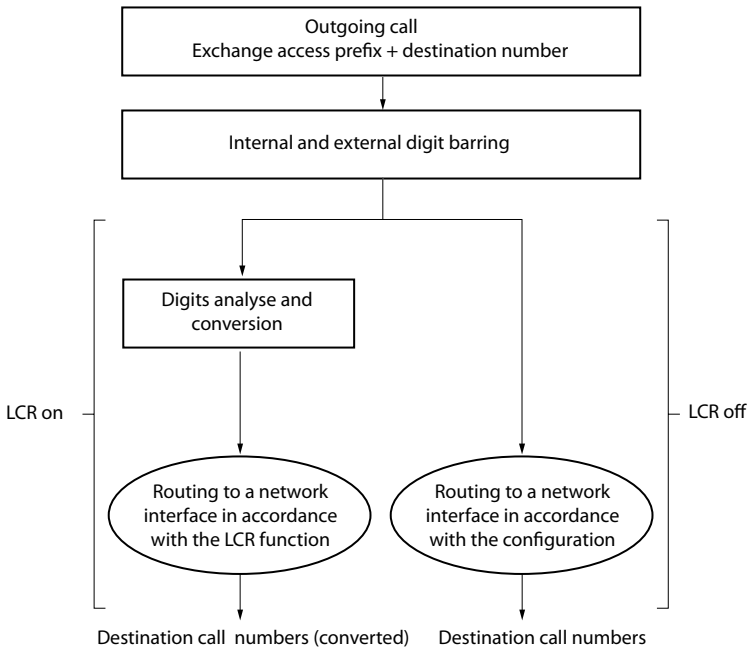

Fig. 96 Outgoing exchange traffic using LCR

The call is analysed and routed in three stages:

- Classification of the outgoing call on the basis of the LCR table and allocation to a particular routing table.
- Using the routing table to select a primary and alternative network provider, depending on the time of day and the weekday.
- Network provider-specific conversion of the phone number and routing of the call on the basis of the network provider table.

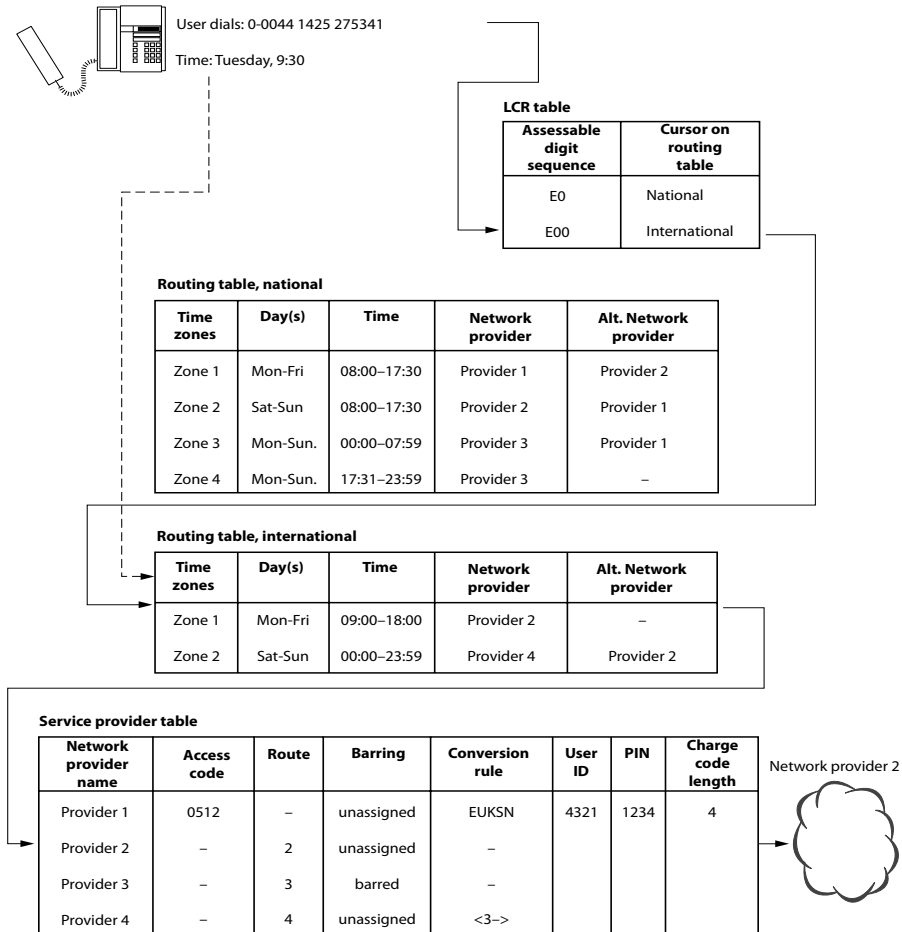

Fig. 97 Example of call routing using the LCR function

6. 6. 3 Allocating the Internal Routing Table (LCR Table)

The LCR table is used to categorize an outgoing call and allocate it to a routing table.

A call is categorized by the evaluation of the phone number digits.

The first digits of an external phone number can be evaluated in terms of the LCR function if they are entered in the LCR table (evaluatable digit sequence) and allocated to a routing table (2nd column). Up to 400 digit sequences can be entered in

total in the LCR table.

An analysable digit sequence can consist of up to 19 digits.

Tab. 59 Example of an LCR table

Evaluatable digit sequences	Routing tables
E0	National
E00	International
E032	–
E0044	United Kingdom
E0044171938	London South West

Based on the entries in this LCR table, calls are routed as follows:

- In this example phone number 0-061 601 22 22 is routed via the National routing table.
- Phone number 0-0033 1 41 23 45 67 is routed via the International routing table.
- Phone number 0-032 631 27 17 is routed in accordance with the user configuration (no LCR routing as no routing table was specified for digit sequence 032).
- Phone number 0-0044 1425 275341 is routed via the "United Kingdom" routing table.
- Phone number 0-0044 171 938 9123 is routed via the "London South West" routing table.
- Phone number 0-631 27 17 is routed in accordance with the user configuration (no LCR routing as the phone number does not contain any analysable digit sequences).

External and PISN-Internal Entries (E and I Prefix)

To indicate whether an entry in the LCR table relates to an external destination in the public network or to a destination in the private leased-line network, the prefix *E* (for external) or *I* (for PISN-internal) must be added to the digit sequence.

Tab. 60 Example of an LCR table with a PISN-internal entry

Evaluable digit sequences	Routing tables
E0	National
E00	International
I62	Region 62

- The external phone number 0-624 38 27 will be routed in accordance with the user configuration (no LCR routing as there is no E entry for digit sequence 62).
- The PISN phone number 62 2020 will be routed via the routing table "Region 62".

Emergency Routing (X Prefix)

If specific phone numbers (e.g. emergency numbers) are to be routed in each and every case (including forced routing) in accordance with the user configuration or user selection and not according to LCR criteria, they must be entered with the prefix "X" in the LCR table.

Example:

- All national calls in Britain are to be routed via network provider A.
- All remaining calls are to be routed via network provider B, reached indirectly, except for the "999" emergency number. This number is to be routed via the settings of the user configuration in all cases.

Tab. 61 Example of an LCR table with the prefix X

Evaluable digit sequences	Routing tables
E0	National
E1	Network group 1
..	...
E9	Network group 9
X999	Emergency

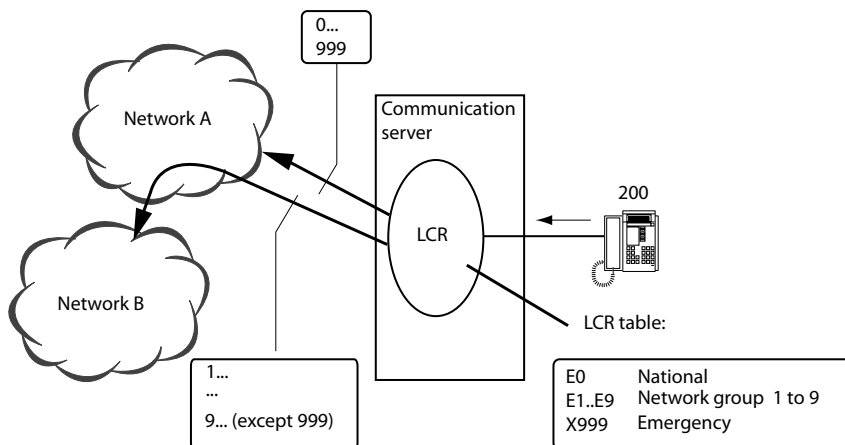

Fig. 98 Routing the emergency number 999

If "E999" is entered for the emergency number instead of "X999", an exceptional routing can be configured. The table below shows the routing for prefixes X and E.

Tab. 62 Difference in routing with the X prefix and the E prefix

Dialling "999" via the various different exchange accesses	Force network provider is enabled ¹⁾		Force network provider is not enabled	
	X999	E999	X999	E999
Business prefix (0)	User config.	LCR config	User config.	LCR config
Private prefix (10)	User config.	LCR config	User config.	LCR config
Cost centre selection prefix (13n)	User config.	LCR config	User config.	LCR config
Route selection prefix (17x)	Route selection	Route selection	User config.	LCR config
Key telephone line key	KT route	KT route	User config.	LCR config

¹⁾ For more on the subject of "Forcing the network provider", see [page 219](#)

User config.: Routing via route in accordance with the user configuration

Config LCR: Routing via route in accordance with the LCR configuration

Route selection: Routing via manually dialled route

KT route: Routing via the route allocated to the KT line in the call distribution element

6. 6. 4 Selecting the Network Provider (Routing Tables)

The routing tables are used to select a primary or an alternative network provider for a categorized call, depending on the time of day and the weekday.

A total of 20 routing tables with up to 10 time zones each can be defined.

Tab. 63 Example of a routing table

Time zones	Day(s)	Time	Primary network provider	Alternative network operator
Zone 1	Mon-Fri.	08:00–17:29	Network provider 1	Network provider 2
Zone 2	Sat-Sun	08:00–17:29	Network provider 2	–
Zone 3	Mon-Sun	00:00–07:59	Network provider 3	Network provider 1
Zone 4	Mon-Sun	17:30–23:59	–	Network provider 1

Depending on the current zone a call will be routed to one of the following network providers:

- Primary network provider
- Alternative network provider (alternative routing)
- Network provider in accordance with the user-specific routing (user configuration)

The criteria for selecting one of these network providers are shown in [Tab. 64](#).

Tab. 64 Selection of the network provider depending on settings and situation

Settings in the routing table		Response of the LCR function
Primary network provider	Alternative network operator	
Network provider 1	–	Routing to network provider 1; if this is not possible, routing in accordance with the user configuration.
Network provider 1	Network provider 2	Route to network provider 1; if this is not possible, alternative routing to network provider 2
–	Network provider 2	Routing in accordance with the user configuration; if this is not possible, alternative routing to network provider 2.
–	–	Routing in accordance with the user configuration

If neither the network provider selected initially nor the alternative network provider is available, the call will be cleared down. The caller will obtain the congestion tone.

Automatic alternative routing can be activated or deactivated throughout the system.

6.6.4.1 Time zones

The time zones are used to allocate network providers depending on the time of day. This means it is possible to take account of the fact that network provider 3 for example is more cost effective at night than network provider 2

If the time at which a connection is set up is outside the defined time zones the call is routed in accordance with the user configuration (without LCR function).

If the time indications of several time zones overlap, the time zone placed further up in the table applies to the area of overlap:

Tab. 65 Example of overlapping time zones

Time zones	Day(s)	Time	Primary network provider	Alternative network operator
Zone 1	Mon-Fri	07:00-16:59	Network provider 1	Network provider 2
Zone 2	Mon-Sun.	00:00-23:59	Network provider 2	–

Tab. 66 Zone 1 applies in the overlap area

Time	00:00:00 to 06:59:00	07:00:00 AM to 04:59:00 PM	17:00:00 to 23:59:00
Zone 1		Network provider 1	
Zone 2	Network provider 2		Network provider 2

6.6.4.2 Alternative Routing (Fallback Routing)

If the LCR function realizes that access to the network provider initially selected is not possible, a call is routed to the alternative network provider and an event message is generated (*LCR via alternative network provider*).

The LCR function recognizes that access to a network provider is not possible if,

- if all the B channels in the selected route are busy or out of order,
- routing via the primary network provider is barred in the network provider table,
- the network signals to the communication server that the primary network provider is not available (e.g. due to overloading).

Manual alternative Routing

In some situations the LCR function cannot recognize that the primary network provider is not available (for example if the network provider answers the call with a voice message). The user then has the possibility to dial via the alternative network provider manually. To do so he interrupts the connection and dials *90. The

number is then redialled in the same way as with a last-number redial but this time via the alternative network provider.

If the user routes a call via the alternative network provider manually, no event message will be generated.

If users are not to be authorized to dial the alternative network provider themselves, *90 should be barred in the internal digit barring.

Manual alternative routing also works if automatic alternative routing is not activated.

6. 6. 4. 3 Restricted scope of performance by a Network Provider

Not all network providers offers every service (voice, fax, data traffic, etc.) If for example the network provider table contains network providers that can only transfer voice service, users will have to manually force the data service-compatible network provider they want when setting up data connections (see "[Bypassing LCR manually \(Forced Routing\)](#)", page 219).

6. 6. 5 Conversion and Routing (Network Provider Table)

The phone numbers are converted specifically for each network provider based on the network provider table; the call routing is then determined. 20 network providers can be entered in the table.

Tab. 67 Network operator table

Network Provider	Access code	Route	Barring	Conversion rule	User ID	PIN	Charge code length
Network provider 1	0512	–	unassigned	EUKSN	4321	1234	3
Network provider 2	–	2	unavailable	–			
Network provider 3	–	3	unassigned				

Settings of the network provider table:

- Access code:
Used for indirect access to a network provider. For direct access to a network provider, indicating a route is sufficient.
Maximum access code length: 12 digits.

- **Barring:**
Enable or bar call routing to the corresponding network provider.
- **User-ID / PIN:**
syntax and length depend on the network operator.
- **Call charge code length (single digit: <1..5>):**
reduces the call charge code called up in the conversion rules to the specified length, starting from the end. Example:
 - In the conversion rule the user number is called up as a call charge code.
 - The call charge code length is set to "3".
 - User number 3426 is transmitted as call charge code 426.

Conversion Rules

The conversion rules specify how a dialled phone number is to be converted to enable automatic access to a network provider.

Tab. 68 Conversion rule parameters

Parameter	Meaning
<i>E</i>	Add access code
"0"_"9", "*", "##"	Add specified characters
<i>N</i>	Add dialled phone number
<x-y>	Add digit x to digit y to the phone number
<i>Z</i>	Switch over to frequency dialling (DTMF mode)
<i>P</i> _{<i>n</i>}	Pause (n = 1-9 [seconds])
<i>U</i>	Add user ID
<i>K</i>	Add PIN (Personal Identification Number)
<i>S</i>	Add user number as call charge code (only <i>S</i> or <i>C</i>)
<i>C</i>	Add cost centre as call charge code (only <i>S</i> or <i>C</i>)

- x- defines the start position for creating the substring;
if x is not specified, 1 is considered as the start position.
- y defines the end position for creating the substring;
if y is not specified, the last digit of the number is considered as the end position.
- x / y If x or y only is specified without separator, the designated position applies.

Tab. 69 Examples for parameter <x-y>

Parameter	Meaning
<2-4>	3 digits from the second position of the number dialled
<3->	All the digits from the third position to the end (corresponds to <3->)
<-5>	The first 5 digits (corresponds to <1-5>)

Parameter	Meaning
<3>	The third digit only (corresponds to <3-3>)
<.>	The last digit only
<1->	The entire number (corresponds to <1-> and N)

A conversion rule can have up to 20 characters in total. The result string generated from the conversion rule must not exceed a maximum of 40 characters.

Examples Relating to the conversion Rules

Access code for network B via network A: 132

User dials: 0-0 1222 774518

User-ID: 26013

PIN: 7725

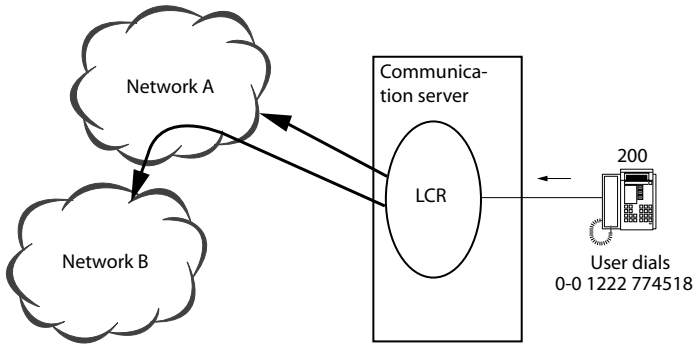

Fig. 99 Reference illustration for the following examples

Tab. 70 Table with examples of conversion rules and phone numbers converted accordingly

Rule	Conversions	Result string
EN	Access code + number dialled	13201222774518
E<3->	Access code + all the digits of the dialled number from the third position onwards	13222774518
<1>E<2->	1. First dialled digit + access code + second to last dialled digits	01321222774518
00EN	00 + access code + number dialled	0013201222774518
EZP2<3->#	Access code, DTMF dialling, 2 s pause + third to last dialled digit + #	132 222774518 #
EZUP2N	Access code, DTMF dialling, User ID, 2 s pause, phone number	132 2601301222774518
EZUKSN	Access code, DTMF dialling, User ID, PIN, User No. as call charge code, phone number	132 26013772520001222774518

Digits dialled in DTMF mode are **highlighted in bold type**.

6.6.6 Bypassing LCR manually (Forced Routing)

A user may be authorized through the user configuration to determine the network provider himself by bypassing the LCR settings (*Force route = Yes*).

Depending on whether the network provider he wants is connected directly or indirectly, the user will add to the phone number either a route prefix or the prefix of the network provider he wants.

Directly connected Network Provider

With route selection the user can dial into the network of a directly connected network provider (direct access).

Calls with other exchange access prefixes will be routed via the LCR function even if authorization is enabled (Tab. 71).

Tab. 71 Call routing to a directly connected network provider

Exchange access prefix	Force network provider is enabled	
	no	yes
Business (0)	LCR routing	LCR routing
Private (10)	LCR routing	LCR routing
Cost centre selection (13n)	LCR routing	LCR routing
Route selection (17x)	LCR routing	Routing in accordance with route selection

Indirectly connected Network Provider

If the network provider the user wants is not connected directly (indirect access), the user dials as a prefix the number required or the necessary code.

Tab. 72 Call routing to an indirectly connected network provider

	Force network provider is enabled	
	no	yes
User dials network provider number or code	LCR routing	Routing as per user's choice

6. 6. 7 LCR with Key Telephones

LCR routing when dialling via the line keys depends on the *Force route* authorization.

- *Force route* enabled:
Routing is effected via the KT route as with a deactivated LCR function.
- *Force route* not enabled
Routing is effected via the LCR function.

6. 6. 8 LCR in the private Leased-line Network

Where the LCR function is concerned, a private leased-line network (PISN) is a special network provider, characterized as follows:

- A PISN is usually reached directly (see "[Direct Network Access](#)", page 207).
- Digit sequences of PISN-internal phone numbers must be entered with the I-prefix in the LCR table (see "[External and PISN-Internal Entries \(E and I Prefix\)](#)", page 211)
- Overflow routing from the PISN to the public network is implemented with the LCR function by entering the PISN as the primary network provider and the public network provider as the alternative network provider. Unlike fallback routing, routing to the alternative network provider does not generate an event message (see also "[Alternative Routing \(Fallback Routing\)](#)", page 215).



Aastra Intelligent Net:

In an AIN the master's LCR configuration always applies to all the nodes. The LCR configuration of a satellite is effective in the offline mode only (i. e. when the connection to the master is interrupted).

6.6.9 Call logging and Data Protection

In connection with the LCR function, the OCL output format PC5 (recommended) or PC4 must be used (see "Output formats", page 286).

When the data protection function is activated, the following data will not be output or output only in part, in OCL output format PC5 and PC4:

- The last four digits of the phone number dialed by the user will be truncated.
- The last four digits of the phone number dialed by the LCR function will be truncated.
- User IDs and PIN codes will not be output.
- User IDs and PIN codes will also be suppressed when the LCR tables are printed out.

6.6.10 Examples of LCR

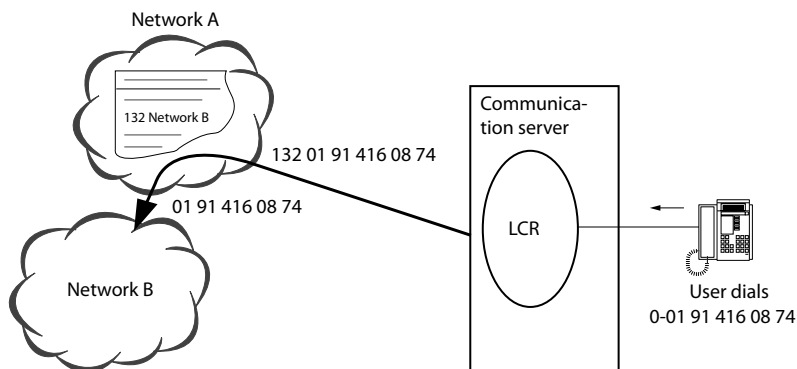

Fig. 100 1. Example: Network provider B is integrated in the numbering plan of network provider A

Tab. 73 1. Example: Entry in the network provider table

Network Provider	Access code	Route	Barring	Conversion rule	User ID	PIN	Charge code length
Network provider B	132	-	-	EN	-	-	-

1. Stage:

- The system reaches network provider B via network provider A
- Network provider B seizes and the connection provider B – communication server is set up

2. Stage:

The system transmits the phone number in DTMF mode in accordance with the configured conversion rule.

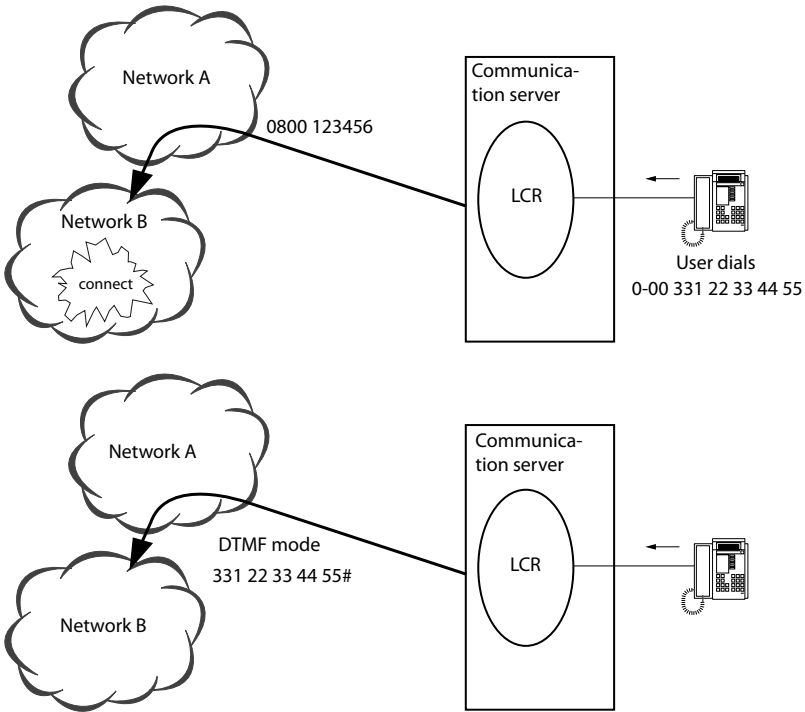

Fig. 101 2. Example: Network provider B is not integrated in the numbering plan of network provider A

Tab. 74 2. Example: Entry in the network provider table

Network Provider	Access code	Route	Barring	Conversion rule	User ID	PIN	Charge code length
Network provider B	0800123456	-	-	EZ<3->#	-	-	-

6.6.11 Higher-Level LCR Settings

The table below summarizes once again the higher-level LCR settings.

Tab. 75 LCR settings

Parameter	Parameter value	Remarks
Least Cost Routing (Account Manager):		
• LCR	On / Off	Activate / deactivate LCR function throughout the system (see page 208)
• Alternative Routing	On / Off	Activate / deactivate alternative routing throughout the system (see page 215)
User configuration:		
• LCR	On / Off	Activate / deactivate LCR function for a specific user (see page 208)
• Force routing (LCR)	yes/no	Bypass LCR manually (see page 219)
• Internal digit barring	Bar *90	Bar manual alternative routing (see page 215)

Default settings

After initialization the LCR function is deactivated.

When activating the LCR function after initialization, automatic alternative routing is activated.

6.7 Exchange-to-Exchange Connection

Exchange-to-exchange traffic covers all interactions involving at least 2 users in the public network and at least 1 internal user.

6.7.1 Exchange-to-Exchange Connections

In an exchange-to-exchange connection two seized exchange lines to the public network are connected with each other locally in the communication server.

Restrictions applicable throughout the system

Exchange-to-exchange traffic can be restricted or barred throughout the system. The setting is not effective for inter-network connections to the public network or to on one side only, e.g. PISN-PISN or PISN-exchange.

The system supports exchange-to-exchange traffic on both digital and analogue network interfaces. The following settings are possible:

- *Not enabled*: Exchange-to-exchange connections not allowed
- *Digital-digital only*: Both network interfaces must be digital
- *Digital-analogue also*: At least one network interface must be digital
- *Analogue-analogue also*: Both network interfaces can be analogue

If sections of exchange-to-exchange connections are analogue, the transmission quality will decrease.

If a user tries to set up an inadmissible exchange-to-exchange connection (e.g. by initiating an exchange enquiry call and then hanging up), the second connection is disconnected and user B obtains long ringing after hanging up, to be able to answer the first connection on hold. This is the case for example if one or both network interfaces are analogue and the parameter is *Exchange-to-exchange connection = Digital-digital only*.



Tip:

In some countries private operators of communication systems are not authorized to transfer an outside call back to the public network. Explain the situation regarding operating rights to operators of communication servers already at the negotiation stage.

User-specific configuration

The settings described in the last section can also be configured individually for each user. The user-specific configuration takes priority over the setting for the system as a whole. If a users settings are not to deviate from the settings made for the system as a whole, the parameter has to be configured to *According to exchange settings* (initialization value).

Specially configured abbreviated dialling numbers

Exchange-to-exchange traffic can be enabled in general for specially configured direct dialling numbers (*Exchange-to-Exchange Connection = Yes*). This allows all types of exchange-to-exchange connections, and is also valid in cases where exchange-to-exchange traffic is barred in the system configuration and the user-specific configuration. The abbreviated dialling number stored does not have to be complete, which means digits can be suffix-dialled manually. This allows for example exchange-to-exchange traffic to be enabled for an entire office branch using a single abbreviated dialling number.

6.7.1.1 Setting up Exchange-to-Exchange Connections

An exchange-to-exchange connection can be set up using Call Forwarding Unconditional, Conference, Call Forwarding on No Reply, Call Deflection and Transfer with or without prior notice.

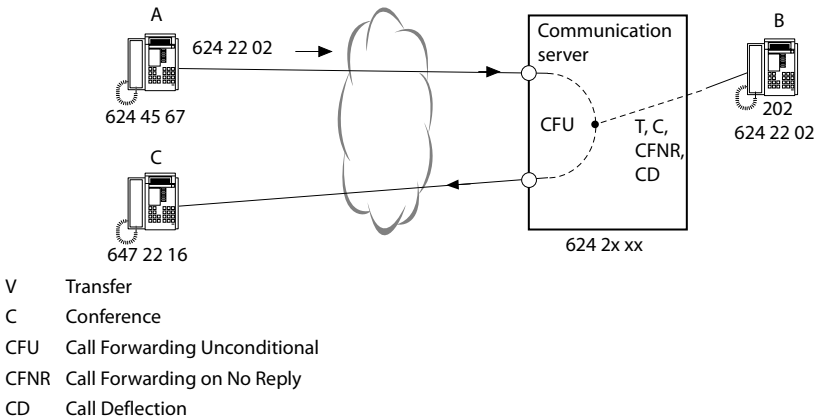

Fig. 102 Exchange-to-Exchange Connection

6.7.1.2 Clearing down Exchange-to-Exchange Connections

Digital-Digital (D-D):

The public network sends the communication server a release signal once the external call partners of an exchange-to-exchange connection have finished the call. The connection can then be cleared down by the communication server.

Without a release signal, the communication server cannot clear down an exchange-to-exchange connection.

The amount of time between completion of the call and the sending of the release signal depends on whether the exchange-to-exchange connection is set up end-to-end within the ISDN network (end-to-end ISDN connection) or whether sections of it are analogue (non-end-to-end ISDN connection).

At transitions to other networks (for example from leased-line-network to mobile phone network) it is possible, due to the lack of correct signalling, that an end-to-end ISDN connection is signalled as a non-end-to-end connection.

End-to-End ISDN Connection

The release signal is sent as soon as the call is completed.

Non-End-to-End ISDN Connection

With non-end-to-end ISDN connections the amount of time between the completion of the call and the release depends on who set up the connection:

- If the connection was set up by the internal user (i.e. from the communication server's viewpoint an outgoing call), and the external partner (user C in [Fig. 102](#)) hangs up, it can take a few minutes for the release signal to be sent.
- If the connection was set up by one of the external partners (i.e. from the communication server's viewpoint an incoming call) and the external partner (user B in [Fig. 102](#)) hangs up, the release signal is sent immediately.



Note:

If two announcement services such as sports and weather information are connected with each other, this exchange-to-exchange connection will not be cleared down automatically. This can lead to high call charges.

Each exchange-to-exchange connection will be cleared down by the communication server after two hours.



Note:

If an exchange-to-exchange connection is transferred to the exchange using Partial Rerouting or Call Deflection, the communication server no longer has any control over the connection and therefore cannot disconnect it.

Analogue-Analogue (A-A) or Digital-Analogue (D-A)

Release on the analogue interface cannot be guaranteed with these connection types. On analogue network interfaces the communication server detects loop interruptions, polarity reversal and congestion tone as release criterion. The detection can be configured for each analogue network interface (CM 2_2_1).

Tab. 76 Release signal: System configuration

Parameter	Parameter value	Remarks
<i>Release signal</i>	<Yes / No>	
<i>Release signal type</i>	<Loop-break / Polarity reversal / Congestion tone >	The frequency and the time sequence of the congestion tone vary from country to country.
<i>Congestion tone level</i>	<Low / High>	The sound level of the congestion tone can vary greatly within a country and depending on the line length. With this setting the detection can be adapted to the existing level.



Aastra Intelligent Net:

Detection of the congestion tone is automatically adapted to the country configured under the AIN region. In an AIN the nodes may be spread over different regions or even countries. An AIN region is assigned to one or more AIN nodes. An AIN region can also be assigned for each trunk group. The trunk group allocation takes priority over the node-specific allocation.

- Any exchange-to-exchange connection is disconnected at the latest after 2 hours.
- The maximum duration of an analogue exchange-to-exchange connection can be further restricted for the A-A connection type (1...120 minutes).



Note:

As release cannot be guaranteed for connection types D-A and A-A, unintentional high costs can occur. What's more the national guidelines and regulations should be observed before enabling these connection types.

System configuration

Tab. 77 Exchange-to-exchange connections: System configuration

Parameter	Parameter value	Remarks
Exchange settings: <ul style="list-style-type: none"> • <i>Exchange-to-Exchange Connection</i> • <i>Disconnect timeout</i> • <i>Wait for connection</i> 	Not enabled / Digital-digital only / Digital-analogue also / Analogue-analogue also <1...120 minutes> Yes / No	Throughout the system valid only for call type <i>Analogue-Analogue</i> For description see page 343
User settings: <ul style="list-style-type: none"> • <i>Exchange-to-Exchange Connection</i> 	Not enabled / Digital-digital only / Digital-analogue also / Analogue-analogue also / According to exchange settings	Priority over the setting for the system as a whole
Abbreviated dialling settings: <ul style="list-style-type: none"> • <i>Exchange-to-Exchange Connection</i> 	Yes / General settings	Priority over the exchange setting for the system as a whole and the user-specific setting

6. 7. 1. 3 Possible Exchange-to-Exchange Connections

The following system features can be used to set up exchange-to-exchange connections:

- Call Forwarding Unconditional
- Call Forwarding on No Reply
- Call Deflection
- Switching calls
- Conference circuit

The following tables and examples illustrate which features are available in which situations.

Connecting an incoming call with an outgoing call

An incoming call is diverted to the public network, forwarded on or connected in a conference.

Tab. 78 Features supported

User A	→	Call Forwarding Unconditional Call Forwarding on No Reply Call Deflection Switching calls Conference circuit	→	User C
--------	---	--	---	--------

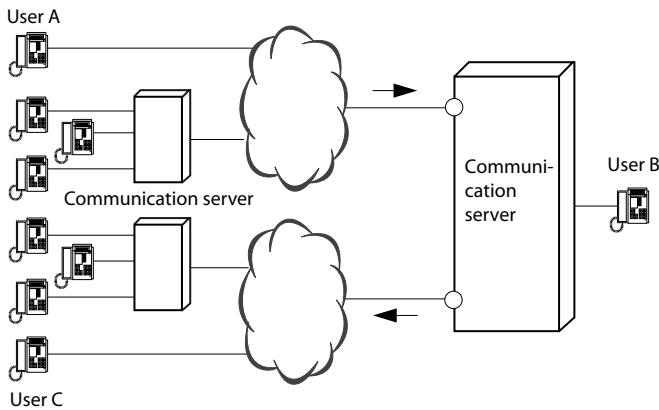

Fig. 103 Connecting an incoming call with an outgoing call



See also:

"Wait for connection setting", page 343.

Connecting two outgoing calls

This situation occurs for example

- when setting up a conference when both conference parties are called.
- when the attendant sets up a connection for a member of staff, then calls him back and transfers the call.

Tab. 79 Features supported

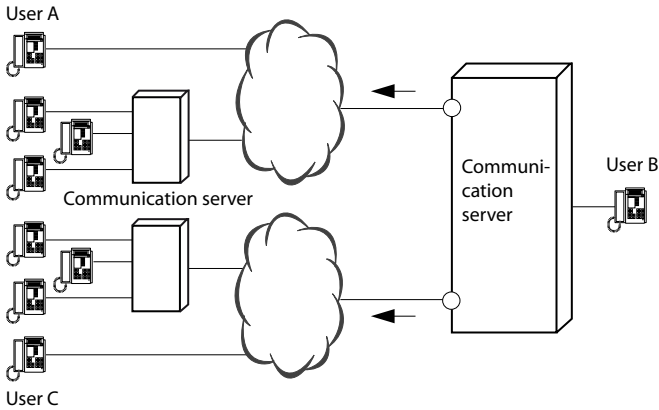
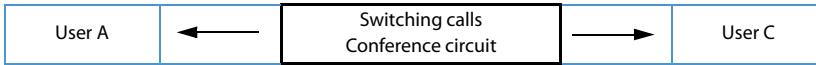

Fig. 104 Connecting two outgoing calls

Two incoming calls

The B channels of two incoming calls can be connected with each other via a conference circuit or by a normal call handover by going on-hook (transfer).

Tab. 80 Features supported

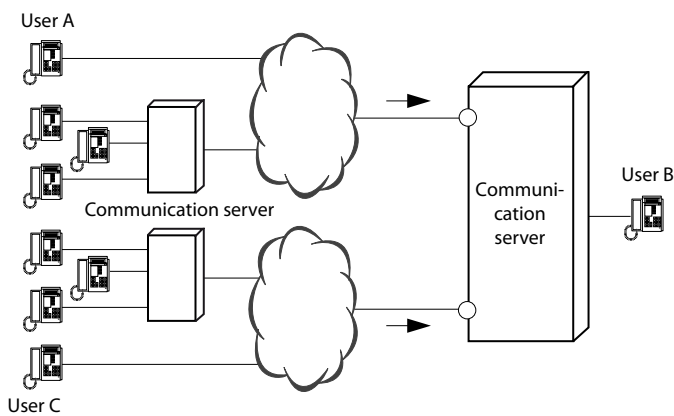
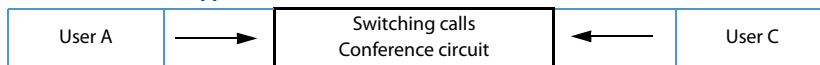

Fig. 105 Connecting two incoming calls

Preventing pointless Exchange-to-Exchange Connections

To prevent exchange-to-exchange connections being set up with announcement services or with special numbers (e.g. info boxes), the numbers concerned should be barred in the digit barring.

6.7.2 Transferring Call Forwarding Unconditional to the Exchange

Internal users can divert their terminal to external destinations. When an external user calls the destination diverted externally, the exchange-to-exchange connection created occupies two B channels.

The system can be configured so that such call forwarding are transferred from the communication server to the public network, thus freeing the two B channels. To do so, the system automatically activates the supplementary services partial re-routing (in point-to-point operation) and call deflection (in point-to-multipoint operation).

The users themselves are not aware of this process.

The called user in the public network is presented with the caller's CLIP as well as information on who redirected the call.

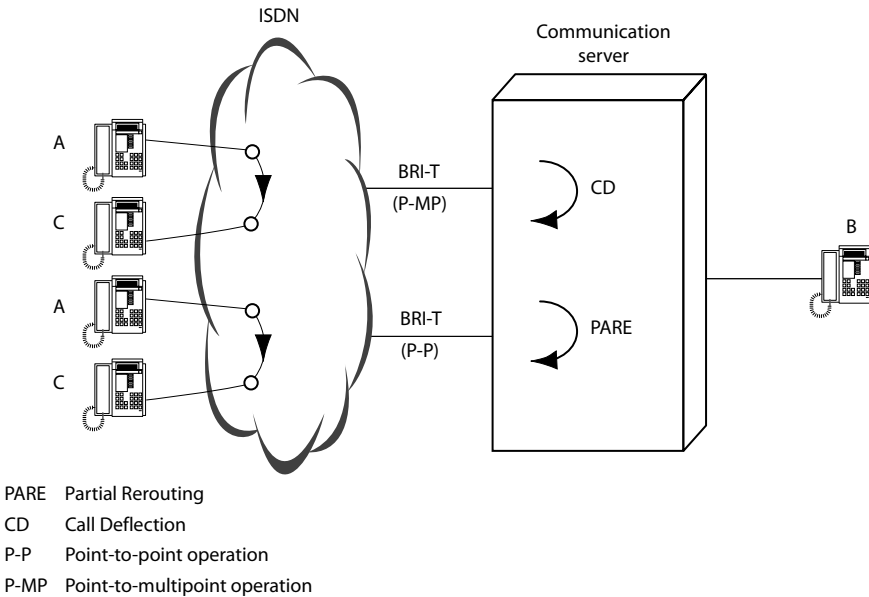

Fig. 106 Transferring Call Forwarding Unconditional to the Exchange

Call Deflection

Call Deflection (CD) is a supplementary service for ISDN users and is available only on a point-to-multipoint connection. Call deflection can be used to reroute a call during the ringing phase. The feature is also provided at the user interface (see "[Deflecting a call during the ringing phase \(CD\)](#)", page 349).

Partial Rerouting

Partial rerouting (PARE) is a supplementary service for communication system operators and is available only on a point-to-point connection (basic and primary rate access).

Call Forwarding Procedure

Call Forwarding Unconditional is transferred to the exchange as follows (Fig. 106):

- User B activates a Call Forwarding Unconditional to user C.

- User A calls user B.
- The communication server carries out the Call Forwarding Unconditional locally in the communication server. 2 channels B are busy
- The communication server activates PARE or CD at the public network provider.
- The network provider takes charge of the Call Forwarding Unconditional; the 2 B channels are freed.
- User C is called. He is presented with user A's phone number and the redirecting information by way of CLIP. At the same time the redirecting information is also transmitted back to user A (see "[Display for Call Forwarding Unconditional](#)", page 81).

Call charges:

- User pays the call charges up to the call forwarding location in the network.
- User B pays the call charges from the call forwarding location to user C.

Call Forwarding Functions Supported

The system routes the following call forwarding to the exchange:

- Call Forwarding Unconditional (CFU)
- Call Forwarding Busy (CFB)
- Call Forwarding on No Reply (CFNR)
- Call Deflection (CD) by a user (forwarding a call during the ringing phase)

With all call forwarding functions the call only continues ringing at user C once it has been forwarded to the exchange.

Prerequisites

Call forwarding to the exchange is subject to the following requirements:

- ISDN network interfaces BRI-T/PRI (QSIG and analogue are not supported).
- In point-to-point operation the supplementary service partial rerouting must be available (subscription may be required).
- In point-to-multipoint operation the supplementary service call deflection must be available (subscription may be required).
- User B must be defined as a *User*-type individual destination in the call distribution element used by user A to make his call.

- The relevant authorizations must be enabled.
- If the call number of the external call forwarding destination is entered as an analysable digit sequence in an LCR table and LCR is activated, the parameter *Use rerouting in the exchange (PARE)* must be configured to *Yes* in the Account Manager.

System configuration

Tab. 81 Transferring Call Forwarding Unconditional to the exchange: Settings

Parameter	Parameter value
User configuration:	
• <i>Exchange access authorization</i>	<i>yes</i>
• <i>Rerouting in the Exchange (PARE)</i>	<i>yes</i>
Trunk group configuration:	
• <i>Rerouting in the Exchange (PARE)</i>	<i>yes</i>
• <i>PSTN supports 'Identity of Charge'</i>	<i>yes</i> ¹⁾
• <i>Network type</i>	<i>Public</i>
• <i>Protocol</i>	<i>DSS1</i>
Call distribution element:	
• <i>Destination</i>	<i>User</i>
Account Manager:	
• <i>Rerouting in the Exchange (PARE)</i>	<i>yes</i>

¹⁾ If the parameter is configured to *Yes*, the communication server also sends the call charge identity when call forwarding to the exchange is transferred. This ensures that call charge information is correctly logged in the communication server. The parameter setting depends on whether or not the network operator supports *Identity of Charge*.

6.7.3 Three-Party Connections in the Exchange

A locally implemented three-party connection with two external users takes up two B channels.

In point-to-multipoint operation the system can be configured so that the node of such a three-party connection is transferred from the communication server to the public network, thereby freeing up at least one B channel and other system resources. To do so the system accesses the supplementary services of the network provider.

The users themselves are not aware of this process.

The following system features can be transferred to the exchange:

Tab. 82 Supplementary services take charge of features transferred to the exchange

System feature	Supplementary service	Feature description
Hold	Hold	see page 365
Enquiry	Inquiry Call	see page 367
Brokering	Brokering	see page 368
Call transfer (with or without prior notice)	Explicit Call Transfer	see page 373
Call back (only after call transfer with prior notice)	Recall	see page 427
Three-party conference	Three-Party Conference	see page 369

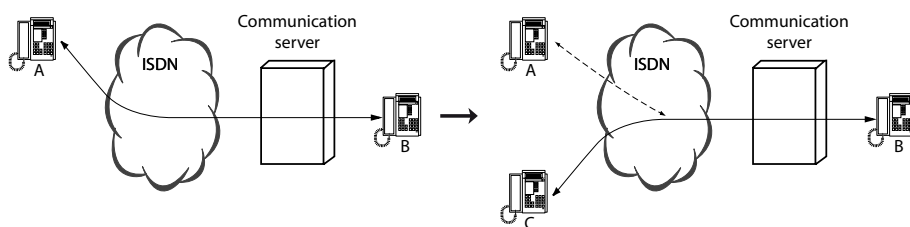
**Fig. 107 External connection followed by hold and enquiry calls**

Description of the Procedure

Calls on hold in the exchange (Fig. 107):

- User A is through to user B.
- User B puts user A on hold: The call is put on hold locally in the communication server.
- User B calls user C: As soon as user B dials the external phone number; the communication server transfers the locally held call to the exchange by activating the Hold supplementary service with the network provider.

All the other three-party connections can be set up from this situation. Example with brokering:

- User A is on hold in the exchange
- User B is through to user C.
- User B brokers to user A:
As user A in the exchange is on hold, the communication server itself does not broker; instead it requests the network provider to do so (by sending "hold" for user B and "retrieve" for user A).

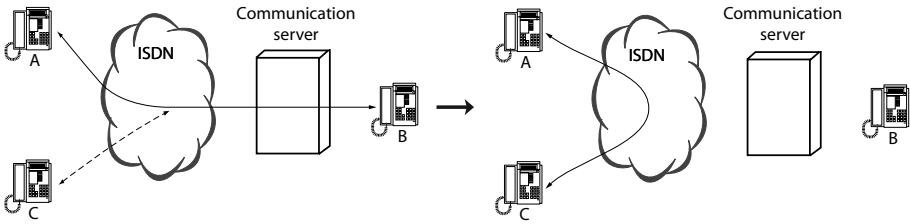

Fig. 108 Brokering followed by call transfer

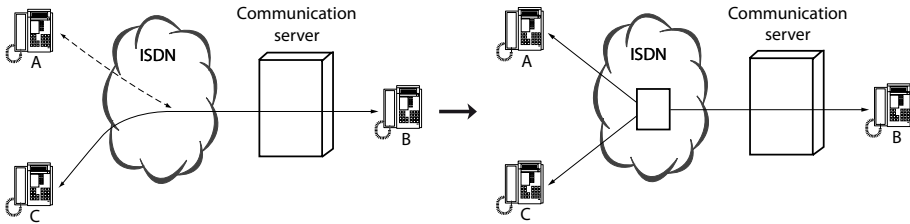

Fig. 109 Enquiry call and brokering, followed by three-party conference

Prerequisites

The following requirements have to be met for three-party connections in the exchange to be activated:

- Basic accesses in point-to-multipoint operation (DSS1 only; QSIG and analogue not supported).
- For Italy only: Basic accesses in point-to-point operation (DSS1 only; QSIG and analogue not supported).
- The supplementary services required must be available at every basic access at which the function is to be supported (subscription may be required).
- The enquiry call connection must be set up as an outgoing call by the internal user. It has to be routed via the same basic access as the first connection.
- Authorisations must be enabled (see "[System configuration](#)", page 237).

Response of the Communication Server if the Procedure Fails in the Exchange:

- Hold cannot be transferred to the exchange:
 - The connection is put on hold in the communication server.

- Any subsequently initiated three-party services are carried out locally in the communication server.
- Three-party conference / call transfer in the exchange not carried out:
The communication server cannot carry out the function locally as the call is on hold in the exchange.

System configuration

Tab. 83 Transferring three-party connections to the exchange: Settings

Parameter	Parameter value
User configuration:	
• <i>Exchange access authorization</i>	<i>yes</i>
Network interface:	
• <i>TEI management</i>	<i>P-MP</i>
Trunk group configuration:	
• <i>Transfer hold to the exchange</i>	<i>yes</i>
• <i>Three-party conference in the exchange</i>	<i>yes</i>
• <i>Call transfer in the exchange</i>	<i>yes</i>
• <i>Network type</i>	<i>Public</i>
• <i>Protocol</i>	<i>DSS1</i>
• <i>Trunk connections</i>	Group in the same trunk group all the basic accesses that are to support the function

6.8 Transit Routing in the Private Leased-Line Network

When a PINX forwards a call on the network side, it is a transit routing.

If a PINX routes a call from the public network to the private leased-line network or vice versa, it assumes a gateway function. It therefore acts as the gateway PINX for the call.

If a PINX routes a call from a PINX in the private leased-line network to another PINX in the private leased-line network, it assumes a transit function. It therefore acts as the transit PINX for the call.

In this chapter you will find out how Aastra 400 resolves the gateway and transit function, and the settings required.



Note:

A transit call must never be routed from network to network via the same trunk group; otherwise this may lead to endless loops and block all available B channels.

6.8.1 From the Public Network to the Private Leased-Line Network

Routing with Direct Dialling

It is advisable to create direct dial numbers at the gateway PINX for all PISN users. An incoming call from the public network will then be routed on into the private leased-line network in accordance with the information relating to the dialled PISN user.

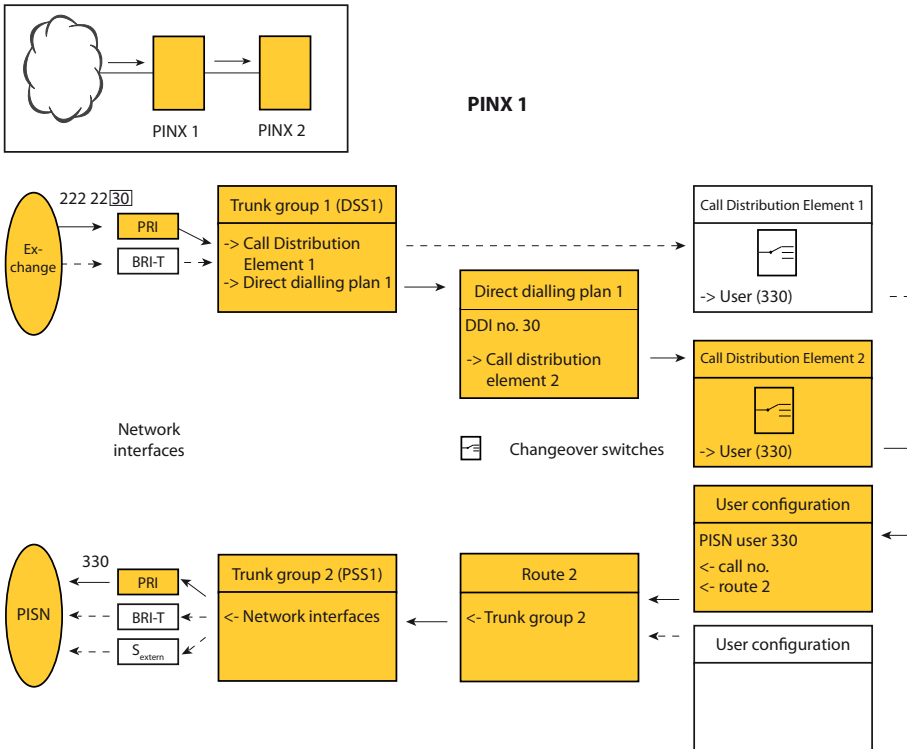

Fig. 110 Transit routing from the public network into the private leased-line network with direct dialling

Tab. 84 Routing parameter settings

Parameter	Parameter value
Trunk group 1:	
• <i>Network interfaces</i>	Network interfaces in this trunk group
• <i>Incoming connection</i>	Number of connections allowed simultaneously

Parameter	Parameter value
<ul style="list-style-type: none"> • <i>Network type</i> • <i>Protocol</i> • <i>Direct dialling plan</i> • <i>Call Distribution Element</i> 	<i>Public</i> <i>DSS1</i> 1 (number of a direct dialling plan) 1 (relevant only if no suitable DD number is found)
Direct dialling plan 1: <ul style="list-style-type: none"> • <i>Direct dialling number 30</i> 	2 (reference number of a call distribution element)
Call distribution element 2: <ul style="list-style-type: none"> • <i>Destinations</i> • <i>Incoming connections</i> 	<i>Switch position 1: 330 (PISN user)</i> Number of connections allowed simultaneously
User configuration PISN-BN 330: <ul style="list-style-type: none"> • <i>Route</i> • <i>Number</i> 	2 (route reference number) Not relevant in this case
Route 2: <ul style="list-style-type: none"> • <i>Trunk groups</i> • <i>Digit barring</i> • <i>Outgoing connections</i> • <i>Numbering plan identifier NPI</i> • <i>Type of number TON</i> 	2 (reference number of one or more trunk group(s)) Use or do not use digit barring Number of connections allowed simultaneously <i>PNP</i> <i>Unknown</i>
Trunk group 2: <ul style="list-style-type: none"> • <i>Network interfaces</i> • <i>Network type</i> • <i>Protocol</i> 	Network interfaces of this trunk group <i>Private</i> <i>QSIG or QSIG/PSS1 ISO</i>

Routing without Direct Dialling

An incoming call from the public network is routed on to the private leased-line network in accordance with the information relating to the PISN user allocated via the call distribution element.

This is useful in only a few instances since all the calls are routed via the same call distribution element.

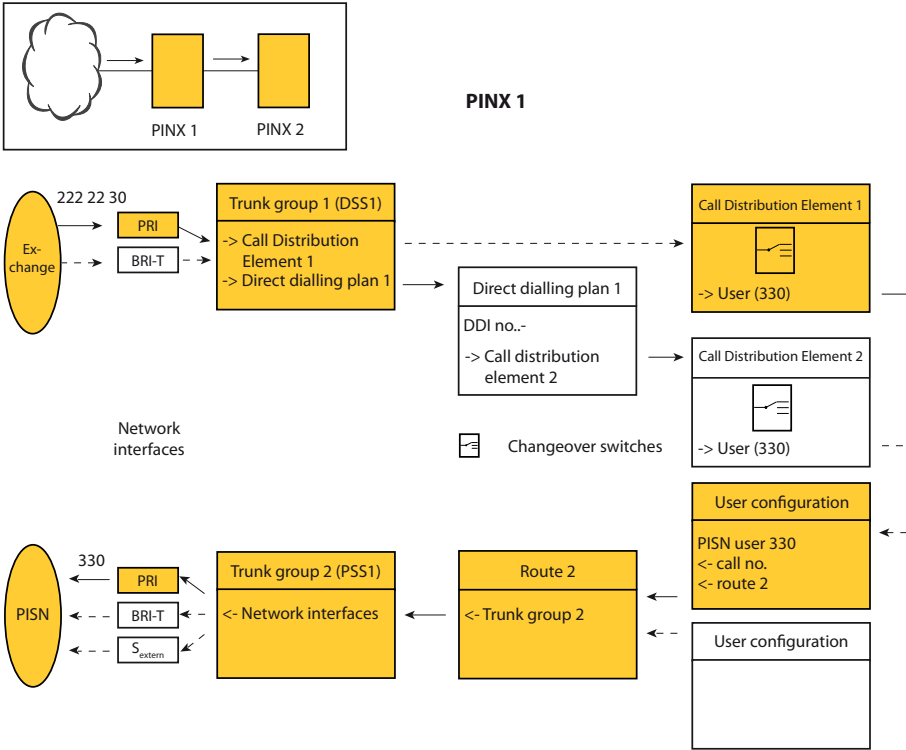

Fig. 111 Transit routing from the public network into the private leased-line network without direct dialling

Tab. 85 Routing parameter settings

Parameter	Parameter value
Trunk group 1: <ul style="list-style-type: none"> • <i>Network interfaces</i> • <i>Incoming connection</i> • <i>Network type</i> • <i>Protocol</i> • <i>Direct dialling plan</i> • <i>Call Distribution Element</i> 	Network interfaces in this trunk group Number of connections allowed simultaneously <i>Public</i> <i>DSS1</i> 1 (relevant only if a suitable DD number is found) 1 (reference number of a call distribution element)
Call distribution element 1: <ul style="list-style-type: none"> • <i>Destinations</i> 	<i>Switch position 1: 330 (PISN user)</i>
User configuration PISN-BN 330: <ul style="list-style-type: none"> • <i>Route</i> 	2 (route reference number)

Parameter	Parameter value
• <i>Number</i>	Not relevant in this case
Route 2: • <i>Trunk groups</i> • <i>Digit barring</i> • <i>Outgoing connections</i> • <i>Numbering plan identifier NPI</i> • <i>Type of number TON</i>	2 (reference number of one or more trunk group(s)) Use or do not use digit barring Number of connections allowed simultaneously <i>PNP</i> <i>Unknown</i>
Trunk group 2: • <i>Network interfaces</i> • <i>Network type</i> • <i>Protocol</i>	Network interfaces of this trunk group <i>Private</i> <i>QSIG or QSIG / PSS1 ISO</i>

6.8.2 From the private leased-line network into the public network

A PINX will route an incoming call from the private leased-line network on towards the public network if the incoming call has a phone number

- *with NPI = E.164* or
- with an exchange access prefix.

call number with **NPI = E.164**

If the numbering plan identifier of an incoming call's phone number corresponds to type E.164, the call will be routed directly to the route set under *Transit route* by the incoming trunk group at a gateway or transit PINX.

The numbering plan identifier is set under *NPI* in the route configuration of the source PINX.

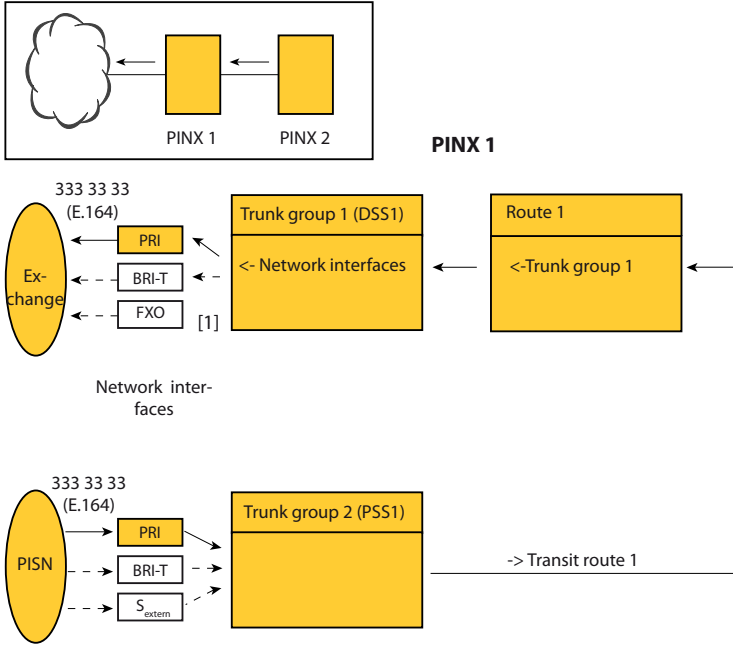

[1] One and the same trunk group cannot contain both analogue and digital network interfaces.

Fig. 112 Transit routing from private leased-line network → public network with NPI = E.164

Tab. 86 Settings for PINX 2 routing parameters

Parameter	Parameter value
Route 1:	
• Trunk groups	1 (reference number of one or more trunk group(s))
• Numbering plan identifier NPI	E.164
• Type of number TON	Unknown
• Send access code	–
Trunk group 1:	
• Network interfaces	Network interfaces of this trunk group
• Network type	Private
• Protocol	PSS1 (QSIG)

Tab. 87 Settings for PINX 1 routing parameters

Parameter	Parameter value
Basic setup PISN:	
• Transit route:	1 (route reference number for transit calls to the public network)
Route 1:	

Parameter	Parameter value
<ul style="list-style-type: none"> • <i>Trunk groups</i> • <i>Digit barring</i> • <i>Outgoing connections</i> • <i>Numbering plan identifier NPI</i> • <i>Type of number TON</i> • <i>Send access code</i> 	3 (reference number of one or more trunk group(s)) Use or do not use digit barring Number of connections allowed simultaneously <i>E.164</i> <i>Unknown</i> –
Trunk group 1: <ul style="list-style-type: none"> • <i>Network interfaces</i> • <i>Network type</i> • <i>Protocol</i> 	Network interfaces of this trunk group <i>Public</i> <i>DSS1</i>

Phone number with an exchange access prefix

If the phone number has an exchange access prefix without route information (*Exchange access business*, *Exchange access private*, *Cost centre selection*), the call will be routed on via the transit route.

If the phone number has a route selection prefix, the call will be routed via the corresponding route.



Note:

If a number has a route selection prefix and if NPI is E.164, the call will be routed via the transit route without truncating the prefix.

The exchange access prefix is set under *Send access code* in the route configuration of the source PINX.

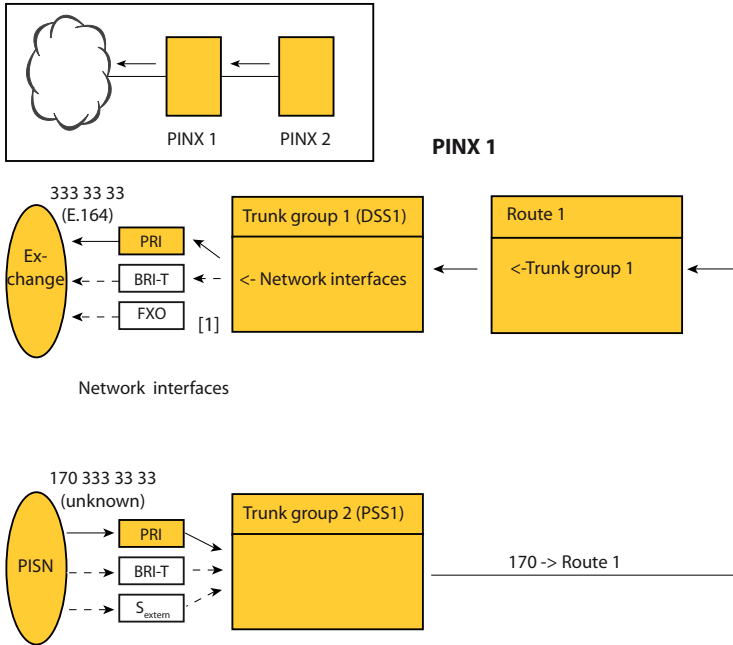

[1] One and the same trunk group cannot contain both analogue and digital network interfaces.

Fig. 113 Transit routing for private leased-line network → public network with exchange access prefix

Tab. 88 Settings for PINX 2 routing parameters

Parameter	Parameter value
Route 1:	
• <i>Trunk groups</i>	1 (reference number of one or more trunk group(s))
• <i>Numbering plan identifier NPI</i>	Unknown
• <i>Type of number TON</i>	Unknown
• <i>Send access code</i>	170
Trunk group 1:	
• <i>Network interfaces</i>	Network interfaces of this trunk group
• <i>Network type</i>	Private
• <i>Protocol</i>	PSS1 (QSIG)

PINX 1 routing parameters as in [Tab. 87](#).

6.8.3 From the private leased-line network into the private leased-line network

A call from the private leased-line network will be routed on at the transit PINX in accordance with the information of the PISN destination user.

If the transit PINX is located in the same region as the destination user, the phone number's regional prefix will be truncated.

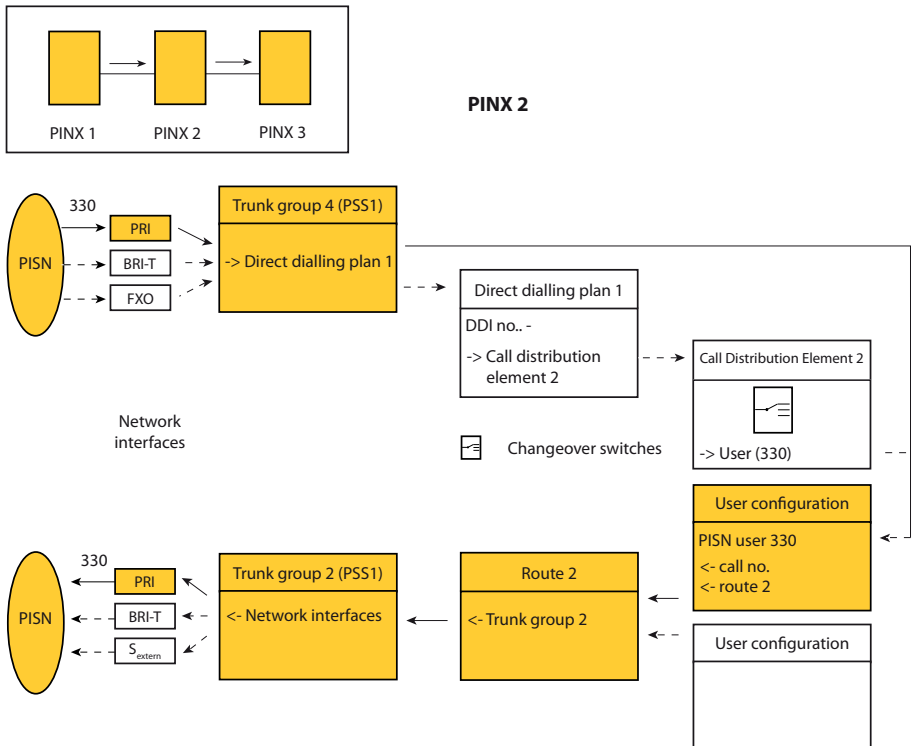

Fig. 114 Transit routing from the private leased-line network to another PISN user

Tab. 89 Routing parameter settings

Parameter	Parameter value
Trunk group 4:	
• Network interfaces	Network interfaces in this trunk group
• Incoming connection	Number of connections allowed simultaneously
• Network type	Private
• Protocol	QSIG or QSIG / PSS1 ISO

Parameter	Parameter value
<ul style="list-style-type: none"> • <i>Direct dialling plan</i> • <i>Call Distribution Element</i> 	1 (relevant only if a suitable DD number is found) Not relevant to this case
User configuration PISN-BN 330:	
<ul style="list-style-type: none"> • <i>Route</i> • <i>Number</i> 	2 (route reference number) Phone number to be dialled without exchange access prefix
Route 2:	
<ul style="list-style-type: none"> • <i>Trunk group 2</i> • <i>Digit barring</i> • <i>Outgoing connections</i> • <i>Numbering plan identifier NPI</i> • <i>Type of number TON</i> 	2 (reference number of one or more trunk group(s)) Use or do not use digit barring Number of connections allowed simultaneously <i>PNP</i> <i>Unknown</i>
Trunk group 2:	
<ul style="list-style-type: none"> • <i>Network interfaces</i> • <i>Network type</i> • <i>Protocol</i> 	Network interfaces of this trunk group <i>Private</i> <i>QSIG or QSIG / PSS1 ISO</i>

6.9 Testing overflow routing in the PISN

When a connection is setup the system checks the availability of the selected path. If it is not available due to overloading or due to a defect, an attempt will be made to set up the connection via an alternative route, depending on the configuration. There are two types of overflow routing:

- Overflow routing within the private leased-line network:
Both the initial and the alternative connection path run via dedicated lines of the private leased-line network.
- Overflow routing via the public network:
The initial connection path runs via dedicated lines of the private leased-line network while the alternative connection path runs via the public network.

Transmission of the CLIP number depends on the CLIP settings. See also the overflow situations illustrated in the example on [page 90](#).

6.9.1 Overflow routing within the private leased-line network

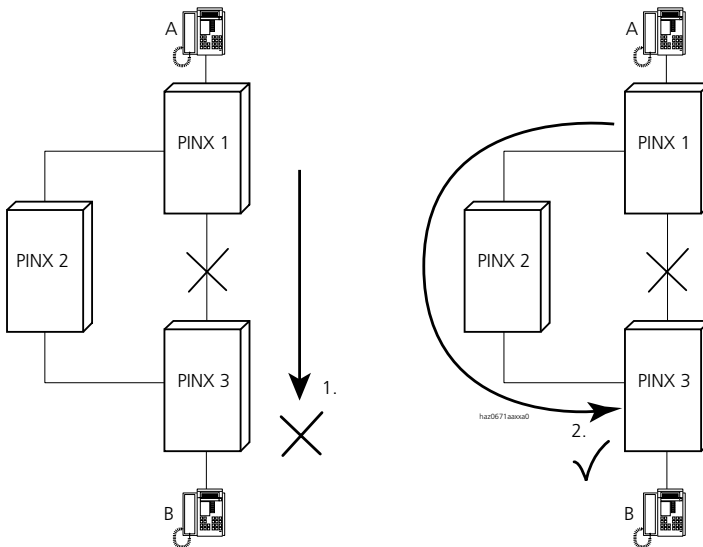

Fig. 115 Overflow routing in the private leased-line network via dedicated lines

Overflow routing in the private network can be resolved with the appropriate route configuration:

Configuration example

In PINX 1 let route 6 be provided for outgoing calls to PINX 3. If trunk groups 2 and 4 are allocated to this route, the first attempt will be to route the call via trunk group 2. If trunk group 2 is not available, the call will be routed via trunk group 4.

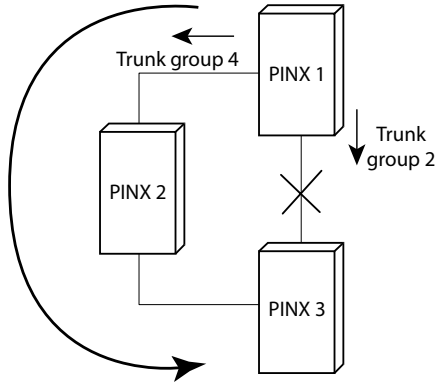

Fig. 116 Overflow routing in the private leased-line network using a sensible trunk group allocation in the route configuration

6.9.2 Overflow routing via the public network

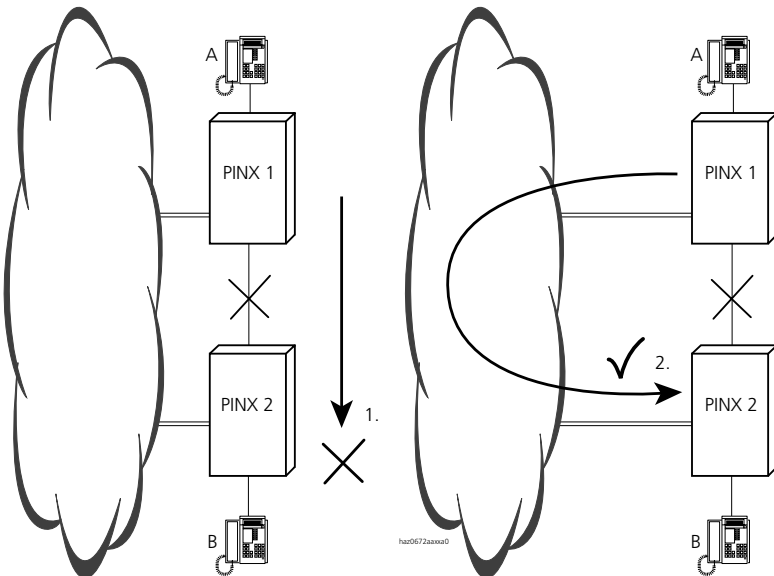

Fig. 117 Overflow via the public network -- the LCR function is used for this purpose
 Overflow routing via the public network is resolved using Least Cost Routing.

Configuration example

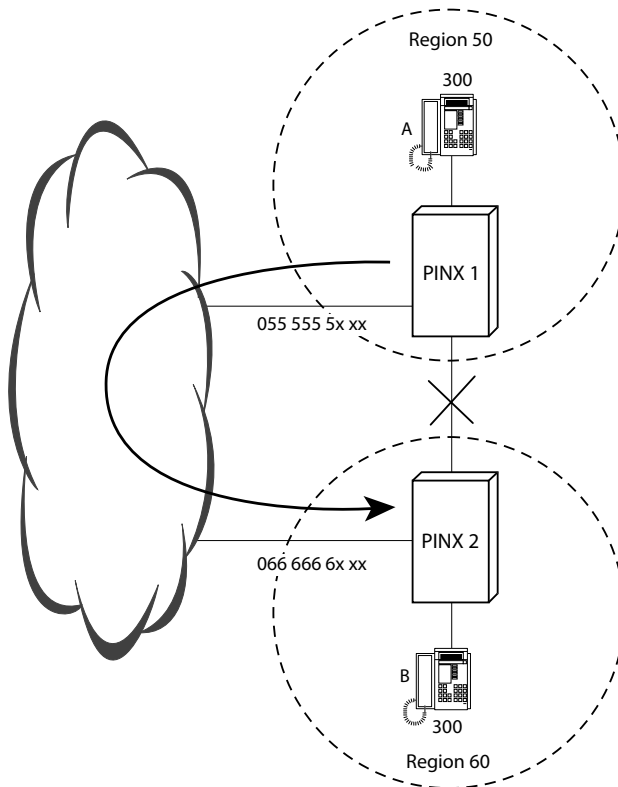

Fig. 118 Configuration example of overflow routing via the public network

In PINX 1's numbering plan, the PISN users of PINX 2 are entered according to the principle 60xxx.

The numbers of the internal users match with their direct dial numbers (user B has internal number 300 and direct dial number 300).

Setting LCR to PINX 1:

- The digit sequence "60" is entered in the LCR table:
All outgoing, PISN-internal calls whose phone number begins with "60" will be analysed by LCR.
- In the routing table the entry for the first network provider stays blank. However, an alternative network provider is entered.

- Under normal conditions, calls whose phone numbers begin with "60" will be routed in accordance with the user configuration. If the normal path is not available, the calls will be routed via the alternative network operator.
- The network operator table determines the route via which the alternatively routed calls are to be routed.
- In the network operator table the PISN phone number must be converted into an external direct dial number. The master number of PINX 2 is used for this purpose without its direct dial portion. The direct dial portion is formed by using the PISN user number without regional prefix.
This means that all the users on PINX 2 need only one entry in the LCR configuration. This can only be achieved if the DDI numbers match the internal user numbers.

Tab. 90 Settings for overflow routing on PINX 1

Parameter	Parameter value
LCR table: • I60 (regional prefix for PINX 2)	O-flow PINX 2 (allocate to routing table "O-flow PINX 2")
Routing table "O-flow PINX 2": • <i>Time zone x</i>	<ul style="list-style-type: none"> • <i>Network provider:</i> - • <i>Alternative network provider:</i> PINX 2 • <i>Time:</i> Allocate the times for "PINX 2"
Network operator table: • <i>Network provider</i> "PINX 2" • <i>Conversion rule</i>	<p><i>Route 6</i></p> <p>0666666<3-> (master number of PINX 2 without three-digit direct dial portion and the last three digits of the dialled phone number. If, for example, user A dials 60300, the number 0666666300 is used, which corresponds to the direct dial number of user B).</p>
Route 6: • <i>Name</i> • <i>Trunk groups</i> • <i>Digit barring</i> • <i>Outgoing connections</i> • <i>Numbering plan identifier NPI</i> • <i>Type of number TON</i>	<p>PINX 2, user</p> <p>2</p> <p><i>No</i> (do not consult digit barring)</p> <p>Number of connections allowed simultaneously</p> <p><i>E.164</i></p> <p><i>National</i></p>
Trunk group 2: • <i>Name</i> • <i>Network interfaces</i> • <i>Network type</i> • <i>Protocol</i>	<p>ISDN exchange</p> <p><i>Network interfaces of this trunk group</i></p> <p><i>Public</i></p> <p><i>DSS1</i></p>

6.10 Break-Out

An outgoing, external call is to be routed into the public ISDN only at the PINX that is closest to the call destination. If the source PINX and gateway PINX are a long way apart and connected with each other via dedicated lines, break-out can help to achieve considerable call charge savings.

For the caller always to be available under the same number regardless of the path via which his calls are routed to the public network, the called party must always be presented with a CLIP with that same number.

If the call is transmitted to the public network via a gateway PINX, the CLIP number will be outside the registered number range. If the network operator is to forward the CLIP number, the service "Special Arrangement" will have to be utilized subject to its availability from the network operator (see also [page 71](#)).

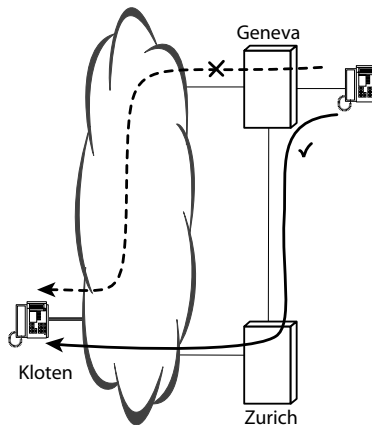

Fig. 119 Break-out

Configuration example

The PINXs of a company with branch offices in Zurich and Geneva respectively are connected with each other via a dedicated line. Outgoing calls made from Geneva to the local rate zone in Zurich are always to be routed into the public network at Zurich.

Incoming calls for the branch office in Geneva are always to be routed from the public network to PINX 1 in Geneva.

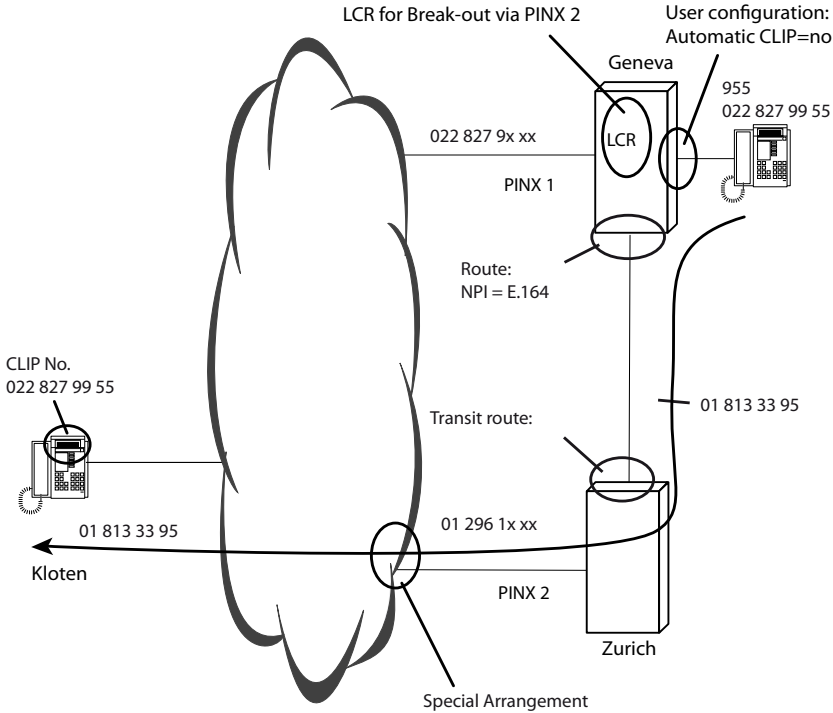

Fig. 120 Topology with important points

Planning the routes and trunk groups

To keep a network configuration as transparent as possible, it is a good idea always to use the same trunk group and the same route for the same function on all the PINXs. It makes sense, for example, to use trunk group 1 in each PINX for connections to the public ISDN network as trunk group 1 has this default value.

Settings on the source PINX (PINX 1):

- **User configuration:**
A permanent CLIP number is configured for internal users in Geneva, which is transmitted unchanged along with each outgoing call to the public network.
- **Least Cost Routing:**
The initial digits of the numbers within the Zurich local rate zone are entered in the LCR table and allocated a route via the routing and network operator table (see also "[Least Cost Routing \(LCR\)](#)", page 206)

- Setting up routes:
 - All calls sent to the public network via Zurich are routed via a separate route. Its configuration must *NPI = E.164* must be set so that PINX 2 recognises a call as external and routes it accordingly.
 - All calls addressed to PINX 2 users in Zurich are routed via another route whose configuration contains the setting *NPI = PNP*.
 - Both routes can be allocated to the same trunk group.
- Trunk group settings:
 - *Network = private*
 - *Protocol = PSS1*
 - *Automatic CLIP = Yes*

Tab. 91 Settings for break-out routing at the source PINX (PINX 1 in Geneva)

Parameter	Parameter value
User configuration: <ul style="list-style-type: none"> • <i>Automatic CLIP</i> • <i>NPI</i> • <i>TON</i> • <i>CLIP number</i> 	<i>No</i> (permanently CLIP number entry is used) <i>E.164</i> <i>National</i> 022 827 9x xx (x stands for the user's DD number)
LCR table: <ul style="list-style-type: none"> • ... • 01 810 • 01 811 • 01 813 • Zurich (allocate to the "Zurich" routing table) Zurich (allocate to the "Zurich" routing table) Zurich (allocate to the "Zurich" routing table) ...
"Zurich" routing table: <ul style="list-style-type: none"> • <i>Time zone x</i> 	<ul style="list-style-type: none"> • <i>Network provider</i>: BreakOutZH • <i>Time</i>: Allocate the times for "BreakOutZH"
Network operator table: <ul style="list-style-type: none"> • <i>Network provider</i> "BreakOutZH" • <i>Conversion rule</i> 	<i>Route 5</i> <i>N</i> (add dialled phone number)
Route 5: <ul style="list-style-type: none"> • <i>Name</i> • <i>Trunk groups</i> • <i>Digit barring</i> • <i>Outgoing connections</i> • <i>Numbering plan identifier NPI</i> 	Zurich, ISDN exchange 2 <i>No</i> (do not consult digit barring) Number of connections allowed simultaneously <i>E.164</i>

Parameter	Parameter value
• <i>Type of number TON</i>	<i>Unknown</i>
Trunk group 2:	
• <i>Name</i>	Zurich, PINX 2
• <i>Network interfaces</i>	Network interfaces of this trunk group
• <i>Network type</i>	<i>Private</i>
• <i>Protocol</i>	<i>QSIG</i> or <i>QSIG / PSS1 ISO</i>
• <i>Automatic CLIP</i>	<i>yes</i>

Settings at the gateway PINX (PINX 2)

Specifying the transit route

The transit route is specified using the *Transit route* setting. If an incoming call has a phone number with numbering plan identifier *NPI = E.164*, it will be forwarded via the defined route. This route leads to the public network (see also [page 241](#)).

Tab. 92 Settings for the break-out routing at the gateway PINX (PINX 2 in Zurich)

Parameter	Parameter value
Transit route:	
• <i>Route</i>	4 (this route is used for the transit routing)
Route 4:	
• <i>Name</i>	Zurich, exchange
• <i>Trunk groups</i>	1
• <i>Numbering plan identifier NPI</i>	<i>E.164</i>
• <i>Type of number TON</i>	<i>Unknown</i>
Trunk group 1:	
• <i>Name</i>	Zurich, ISDN exchange
• <i>Network interfaces</i>	Network interfaces of this trunk group
• <i>Network type</i>	<i>Public</i>
• <i>Protocol</i>	<i>DSS1</i>
• <i>Automatic CLIP</i>	<i>yes</i>

7 Data service

This Chapter deals with outgoing and incoming data service connections. It looks at types of data services, the configuration of data service destination tables, and how data services are routed in the private leased-line network. The user-to-user signalling is also processed.

7.1 Overview

Outgoing data-service connections are set up and routed in a similar way to call connections. This also applies in a private leased-line network.

Incoming data-service connections are routed via data-service destination tables.

To route a call at a gateway or transit PINX on into the private leased-line network, a PISN user is entered as the data service destination (see "[Routing in the private leased-line network](#)", page 260).

Internal data-service connections are also routed via the data-service destination tables (see "[Routing to a destination in the data-service destination table](#)", page 257).

"[User-to-user signalling \(UUS\)](#)", page 262 offers the possibility of exchanging data during the connection setup and disconnection phases.



Aastra Intelligent Net:

In an AIN incoming data service connections are possible only on the Master and only if the Master is connected to the public network. Data service connections are not possible within an AIN (via IP from node to node).

7.2 Data-service connections and destination tables

Data-service connections are routed via the call distribution element to a data-service destination table. In the data-service destination table each data-service type is allocated internal or PISN-internal destinations. There are several data-service destination tables; their number depends on the system type.

The system analyses the data-service type involved and then routes the call to the configured destination.

Destinations include:

- Internal users (including the remote maintenance access)
- User groups
- PISN users
- Data-service individual destination

If the data-service type cannot be unequivocally allocated, it will be routed to the destination *Unknown data service*.

If no destination is found, the call is cleared down.

Tab. 93 Data-service destination table

Data-service type	Interface of the destination terminal
<i>Modem a/b</i>	<ul style="list-style-type: none"> • Analogue terminal interface • Terminal Adapter on an BRI-S terminal interface
<i>FAX 2, 3</i>	<ul style="list-style-type: none"> • Analogue terminal interface • SIP terminal interface
<i>FAX 4</i>	<ul style="list-style-type: none"> • Terminal interface BRI-S • Analogue terminal interface
<i>TA V.110</i>	Terminal Adapter on an BRI-S terminal interface
<i>TA V.120</i>	Terminal Adapter on an BRI-S terminal interface
<i>B channel transparent</i>	<ul style="list-style-type: none"> • Terminal interface BRI-S • Remote maintenance access PPP
<i>Telepac</i>	Terminal Adapter on an BRI-S terminal interface
<i>Teletex</i>	Terminal Adapter on an BRI-S terminal interface
<i>Telex</i>	Terminal Adapter on an BRI-S terminal interface
<i>Videotex</i>	Terminal Adapter on an BRI-S terminal interface
<i>Unknown</i>	Any destination

Routing to a destination in the data-service destination table

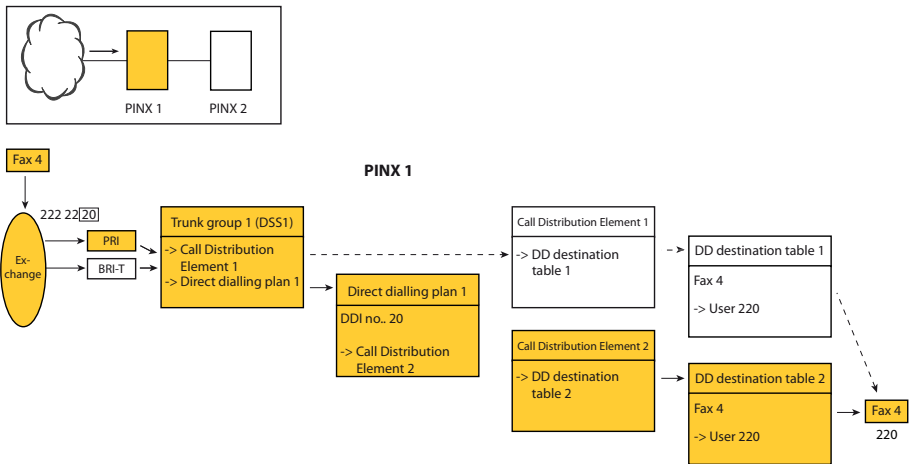

Fig. 121 Incoming data-service routing from the public network with direct dialing to a destination in the data-service destination table

Tab. 94 Routing parameter settings

Parameter	Parameter value
Trunk group 1: <ul style="list-style-type: none"> • Network interfaces • Incoming connection • Network type • Protocol • Direct dialing plan • Call Distribution Element 	Network interfaces in this trunk group Number of connections allowed simultaneously Public DSS1 1 1 (relevant only if there is no suitable DD number)
Direct dialing plan 1: <ul style="list-style-type: none"> • Direct dialing number 20 	2 (reference number of a call distribution element)
Call distribution element 2: <ul style="list-style-type: none"> • Data-service destination table 	2 (reference number of the data-service destination table)
Data-service destination table 2: <ul style="list-style-type: none"> • Data service type <i>Fax 4</i> 	220 (phone number of the data-service destination, Fax 4 in the example)

Routing to a data-service individual destination

If in the data-service destination table *Individual destination* is entered as the destination for a data service type, the call is routed to the destination entered under *Data service individual destination* in the call distribution element.

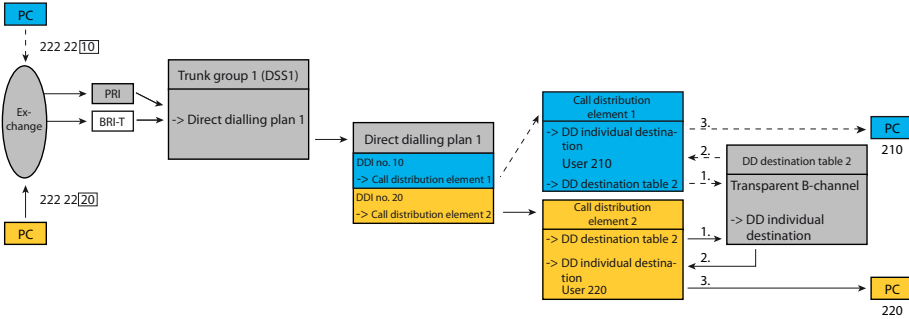

Fig. 122 Incoming data-service routing from the public network with direct dialling to a data-service individual destination

Tab. 95 Routing parameter settings

Parameter	Parameter value
Trunk group 1: <ul style="list-style-type: none"> Network interfaces Incoming connection Network type Protocol Direct dialling plan 	Network interfaces in this trunk group Number of connections allowed simultaneously Public DSS1 1
Direct dialling plan 1: <ul style="list-style-type: none"> Direct dialling number 10 Direct dialling number 20 	1 (reference number of a call distribution element) 2 (reference number of a call distribution element)
Call distribution element 1: <ul style="list-style-type: none"> Data-service destination table Data-service individual destination 	2 (reference number of the data-service destination table) 210 (phone number of the data-service individual destination, in this instance PC 210)
Call distribution element 2: <ul style="list-style-type: none"> Data-service destination table Data-service individual destination 	2 (reference number of the data-service destination table) 220 (phone number of the data-service individual destination, in this instance PC 220)
Data-service destination table 2: <ul style="list-style-type: none"> Data service type <i>B channel transparent</i> 	Data-service individual destination (of the call distribution elements)

The call is also routed to this destination if no data-service destination table is allocated in the call distribution element:

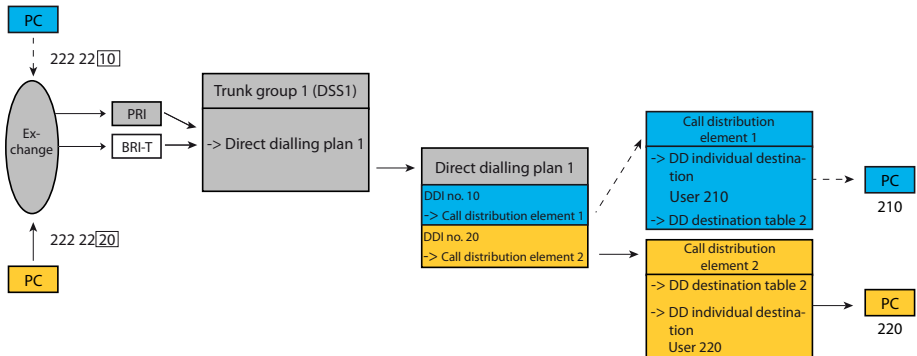

Fig. 123 Incoming data-service routing from the public network with direct dialling to a data-service individual destination but without entry in a data-service destination table

7.3 Routing in the private leased-line network

Data services are also available in the private leased-line network. To route a call at a gateway or transit PINX on into the private leased-line network, a PISN user is entered as the data service destination.

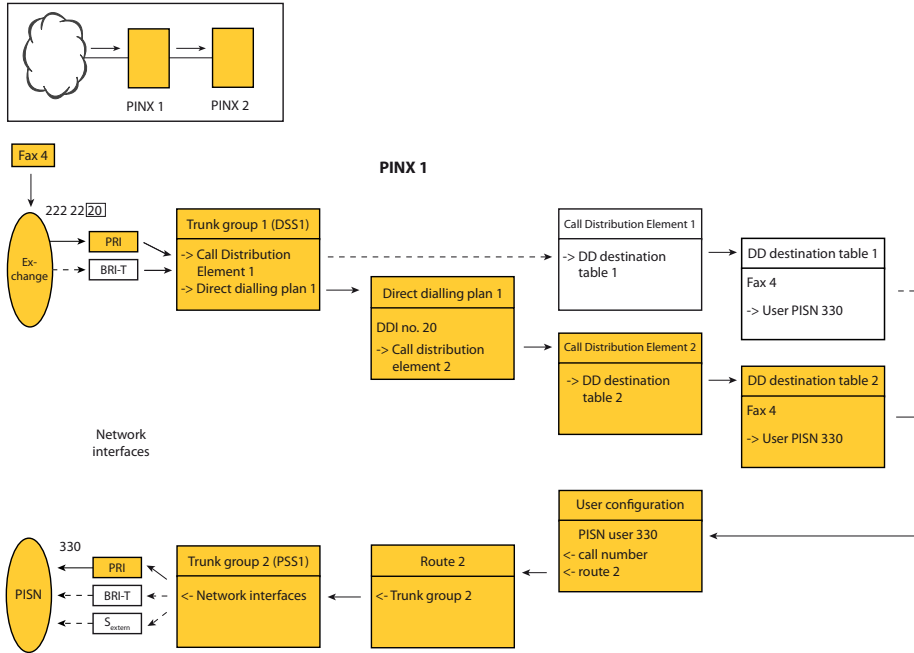

Fig. 124 Data-service routing transit from the public network with direct dialling to another PINX in the private leased-line network.

Tab. 96 Routing parameter settings

Parameter	Parameter value
Trunk group 1:	
• <i>Network interfaces</i>	Network interfaces in this trunk group
• <i>Incoming connection</i>	Number of connections allowed simultaneously
• <i>Network type</i>	<i>Public</i>
• <i>Protocol</i>	<i>DSS1</i>
• <i>Direct dialling plan</i>	1
• <i>Call Distribution Element</i>	1 (relevant only if there is no suitable DD number)
Direct dialling plan 1:	
• <i>Direct dialling number 20</i>	2 (reference number of a call distribution element)
Call distribution element 2:	

Parameter	Parameter value
<ul style="list-style-type: none"> • <i>Data-service destination table</i> 	2 (reference number of the data-service destination table)
Data-service destination table 2: <ul style="list-style-type: none"> • <i>Data service type Fax 4</i> 	PISN user 330
User configuration PISN-BN 330: <ul style="list-style-type: none"> • <i>Route</i> • <i>Number</i> 	2 (route reference number) Phone number to be dialled without exchange access prefix
Route 2: <ul style="list-style-type: none"> • <i>Trunk group 2</i> • <i>Digit barring</i> • <i>Outgoing connections</i> • <i>Numbering plan identifier NPI</i> • <i>Type of number TON</i> 	2 (reference number of one or more trunk group(s)) Use or do not use digit barring Number of connections allowed simultaneously <i>PNP</i> <i>Unknown</i>
Trunk group 2: <ul style="list-style-type: none"> • <i>Network interfaces</i> • <i>Network type</i> • <i>Protocol</i> 	Network interfaces of this trunk group <i>Private</i> <i>QSIG</i> or <i>QSIG / PSS1 ISO</i>

7.4 User-to-user signalling (UUS)

The service "user-to-user signalling" allows users to exchange a limited volume of data (128 bytes per user) among themselves over the signalling channel (D channel) during the phase of connection set-up and clear-down. The exchange of data takes place even if a call is not answered.

Requirements:

- Both users must have subscribed to the service with the network provider.
- The ISDN terminals or CTI applications used must support the service. System phones do not support the service.

Scope

The communication server supports the service in variants 1 and 3 as per ETS 300 286, UUS1.

UUS is not supported in the private leased-line network and is only available at the PINX which is connected to the public network.



Aastra Intelligent Net:

UUS is not supported in an AIN. The service is available only at the nodes that are connected to the public network.

Application examples:

- Message to all callers, stating that the user will only be available again later: User B → user A
- Reference to a required callback: User A → user B
- Appointment transmission: User A ↔ user B
- Advance transmission of a code word or ID for logging into a system (user B) from a CTI application: User A → user B

8 Call logging (CL)

Call data and call charges can be logged and evaluated in great detail with the aid of the system. This Chapter explains the concept of individual charge counting (ICC) and the setting options for logging call data for outgoing (OCL) and incoming (ICL) calls. It also examines other aspects such as the output concept, interface configuration for call data output, output types and the various output formats.

8.1 Overview

Call logging consists of incoming call logging (ICL), outgoing call logging (OCL) and individual charge counting (ICC).

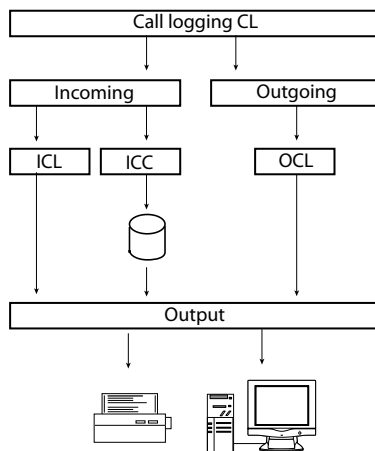

- CL Call Logging
- OCL Outgoing Call Logging (previously charge data acquisition CDA)
- ICL Incoming Call Logging
- ICC Individual Charge Counting

Fig. 125 Call logging at a glance

Individual charge counting or ICC

At the end of a call individual charge counting (ICC) assigns call charges to individually allocated cumulative counters. The data is stored in the communication server, and it can be viewed via the system configuration and output in a variety of ways via the Ethernet interface



See also:

"Individual charge counting or ICC", page 266

OCL and ICL call logging

A multitude of call data from outgoing and incoming calls is logged and output directly via the corresponding interface. The data actually output in each individual case depends on the selected output format (see "Output formats", page 286).

The complete logging of OCL and ICL data for all call, transit, transfer and call connections allows a statistical evaluation of a system's capacity utilisation (OCL as of page 273, ICL as of page 280).

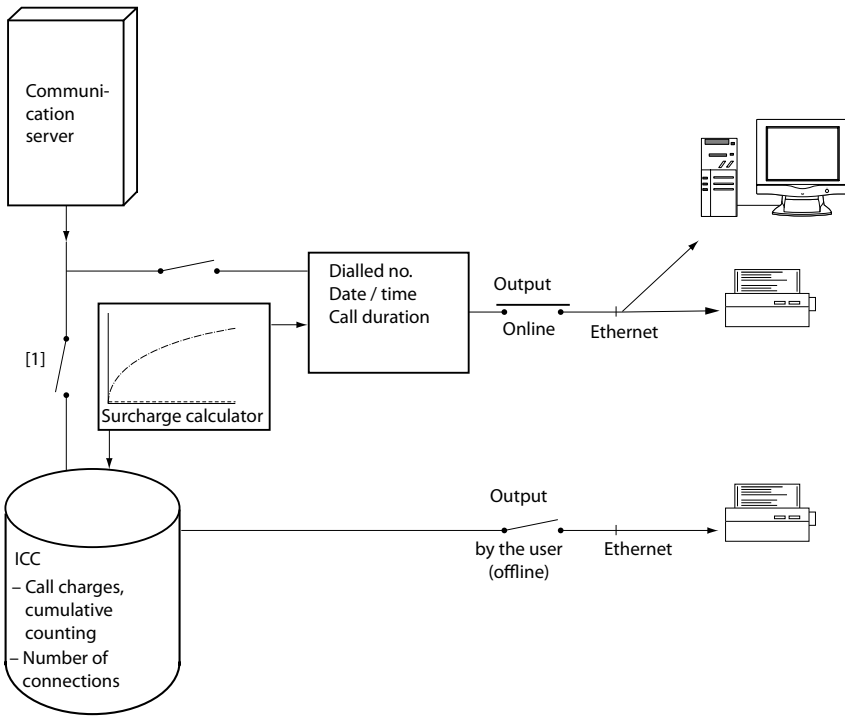

[1] Both OCL and ICC can be activated or deactivated throughout the system

Fig. 126 Call logging and charge acquisition for outgoing traffic

Call logging in the PISN

In a PISN, call data is logged for each PINX. PISN-wide evaluation is carried out using PC-based applications for the acquisition and evaluation of call data.

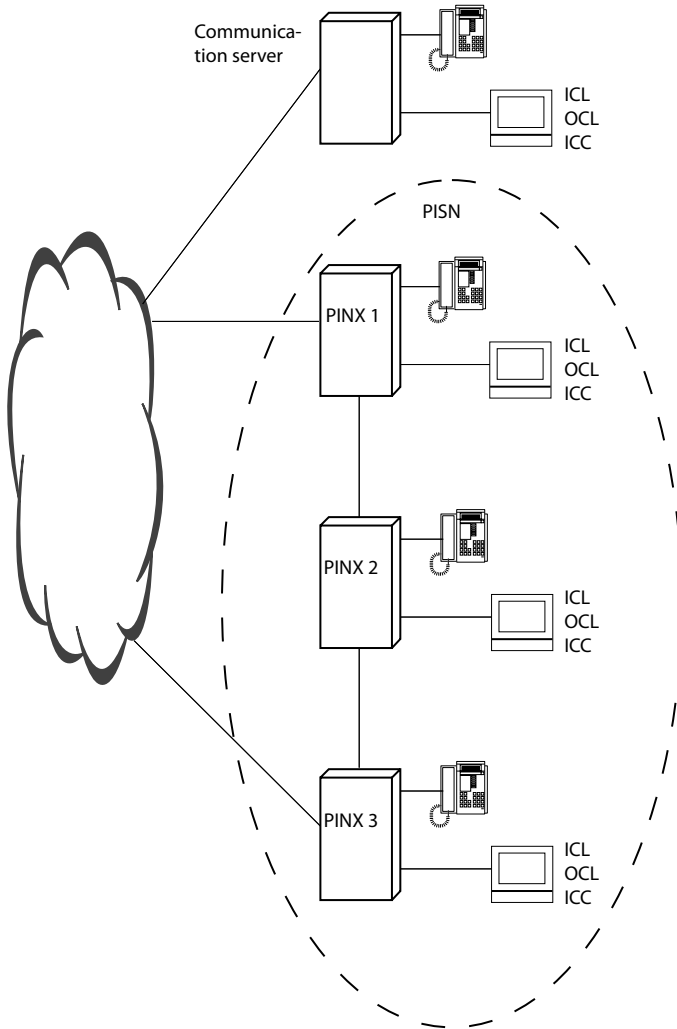

Fig. 127 Call logging in the PISN

8.2 Individual charge counting or ICC

Individual charge counting (ICC) automatically assigns call charges to cumulative counters at the end of a call; these call charges can be viewed in the System Configuration, output at the corresponding interface as individual or complete reports, or deleted.

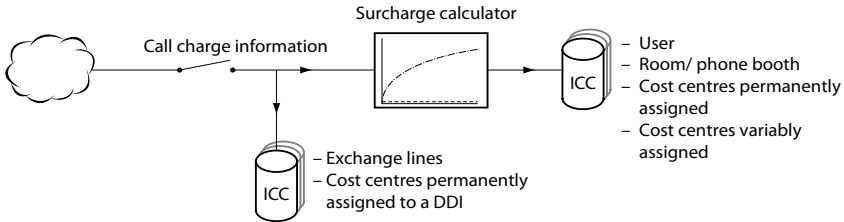

Fig. 128 Call charge allocation

8.2.1 Cumulative counter

In each case there is 1 counter:

- Per network interface
- per user
- Per room
- per cost centre 00 to 99 (see "Cost centres", page 278)

There is also 1 drain counter per communication server (cost centre 100).

In the case of user counters, the ICC differentiates between 3 categories of call charges:

- *Call/data connections, private:*
Here call charges are added up for private calls or data connections to the public network via the *exchange access, private*.
- *Voice calls, business:*
Here call charges are added up for calls to the public network via the *Exchange access business*.
- *Data calls business:*
Here call charges are added up for data calls to the public network via the *Exchange access business*.

Counter readings

Each counter indicates the following values:

- Total amount of the call connections
- Charges for the last call connection
- Number of connections
- Logging period for the call data

Call charge allocation

- Network interface counters add up all the call charges incurred via their network interface.
- If call charges are permanently allocated to a cost centre, they are also counted on the user counter.
- If call data is allocated variably to a cost centre using cost centre selection or the function *78, the data will not be counted at user level.
- If user B has rerouted to the network, user B → user C call charges will be charged to user B.
- When using partial rerouting, the subscriber pays the call charges from the rerouting user to the destination user. The charges are logged in the communication server.
- If a user initiates a transfer call, the call charges incurred will be charged to the user.

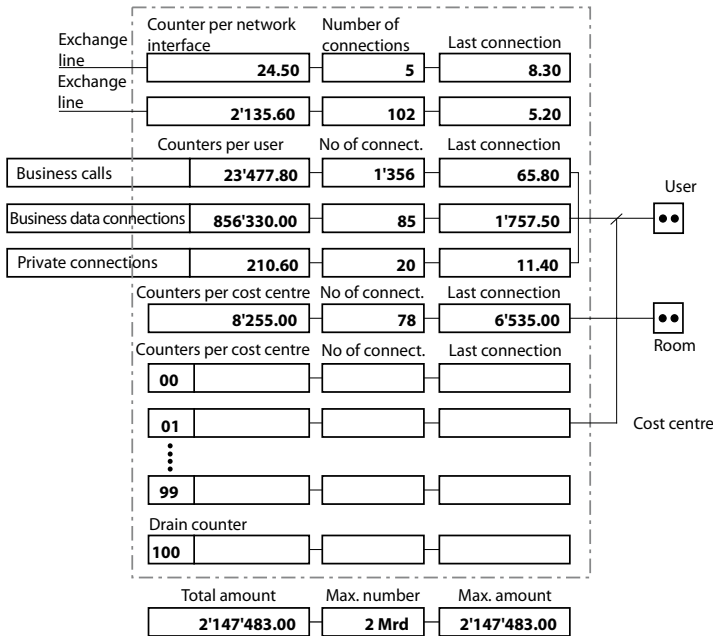

Fig. 129 Example of ICC cumulative counter

Currency

The amounts on the cumulative counters can be displayed in the local currency. The amount per metering pulse and the local currency depend on the parameter settings in the OCL/ICC menu.



Aastra Intelligent Net:

In an AIN call logging takes place centrally on the Master. Call charges are displayed on the system phones in the same format and in the same currency throughout the AIN. However as the nodes may be spread out in different countries, the currency and also the value per charge pulse may also be different and completely falsify the outgoing call logging. That's why it is important in these nodes to use the AMS Configuration Manager to enter the *Exchange rate* for the Master's currency and the *Charge value*. Note:

The more consistently the current exchange rates of the nodes are adapted following exchange rate fluctuations or changes in charge values, the more precisely the outgoing call logging will indicate the actual costs incurred.

drain counter

All call charges that cannot be unambiguously allocated will be added up by the system in a drain counter (cost centre 100). Example: Call charges for a call that was active when emergency operation was released (*Business/Private* allocation not possible).

Application Example

A company has the following departments: Sales, Buying, Development, Production and Logistics. To ensure that the call charges incurred can be allocated to the individual departments, a cost centre is created for each department. This cost centre is permanently assigned to each individual user within each particular corresponding department. This enables the company to determine the call charges for both the department as a whole and the call charges of each individual user.

8.2.2 Surcharge calculator

- The surcharge calculator is activated only if a surcharge curve has been configured and the user has been allocated his business and private calls. No surcharge curves are configured after an initialisation.
- Network interface charge counters and cost centres that are charged via a call distribution element are never subject to the surcharge calculator.
- Call charges are indicated on each system phone with a display while the call is in progress. If the user has been allocated a surcharge calculator, the charges displayed include surcharges.



See also:
"Surcharge calculator", page 275.

8.2.3 ICC reports

ICC reports list all call charges over a user-definable period of time. The reports are output on the printer or PC set up for ICC.

There are two different kinds of ICC reports:

- Individual reports
- Complete reports

Individual reports

Individual reports indicate the call charges of a particular cumulative counter.

```
***** any text (max. 68 characters configurables) *****
CALL FEES                                0032
FROM 21.06.04 14:02 TO 30.06.04 16:00    OFFICE TELEPHONY
NUMBER 20                                51 CALLS    EURO    123.80
```

Fig. 130 Individual report for business telephony calls

```
***** any text (max. 68 characters configurables) *****
CALL FEES                                0032
FROM 21.06.04 14:02 TO 30.06.04 16:00    OFFICE DATA SERVICE
NUMBER 20                                51 CALLS    EURO    123.80
```

Fig. 131 Individual report for business data service calls

```
***** any text (max. 68 characters configurables) *****
CALL FEES    SERVICE INCLUDED            0033
FROM 21.06.04 14:02 TO 30.06.04 16:00    PRIVATE PHONE+DATA
NUMBER 20                                12 CALLS    EURO    15.20
```

Fig. 132 Individual report for private calls (telephony and data service)

```
***** any text (max. 68 characters configurables) *****
CALL FEES                                0033
FROM 21.06.04 14:02 TO 30.06.04 16:00    COST CENTRE
NUMBER 02                                23 CALLS    EURO    23.50
```

Fig. 133 Individual report for a cost centre

```
***** any text (max. 68 characters configurables) *****
CALL FEES                                0035
FROM 21.06.04 14:02 TO 30.06.04 16:00
EXCH 2.2/1                                78 CALLS    EURO    124.30
```

Fig. 134 Individual report for a network interface

***** any text (max. 68 characters configurables) *****			
CALL FEES	SERVICE INCLUDED		0036
FROM 21.06.04 14:02	TO 30.06.04 16:00		ROOM
NUMBER 34	4 CALLS	EURO	18.20

Fig. 135 Individual report for all calls made by Room 34

Individual reports or individual receipts can also specify the following status information:

Tab. 97 Additional information between *Numbers and Connections*

Symbol	Meaning
*	If a cumulative counter has been printed out but not cleared (interim report), the cumulative counter is automatically marked with an "*".
B	If a user happens to be making an external call when his cumulative counter is printed out, this fact is indicated by a <i>B</i> (for BUSY). This information is not displayed in the case of cost centres and network interfaces.

Tab. 98 Additional information after the cumulative counter

Symbol	Meaning
+	The printed cumulative counter has overflowed during operation. The maximum value of 2,147,483 was exceeded; cumulative counting resumes at zero. (If the cumulative counter overflowed only once, the effective final amount can still be calculated by adding the value 2,147,483 to the amount displayed.)
!	An individual call of more than 65,535 charge units was logged during operation.

Complete reports

All cumulative counters are printed out continuously, with a new page for each partial area. The entire header is printed out and a serial number added. If an A4 page is insufficient to hold all the related data of an area, a new page is started, with only the headers repeated to explain the columns. The total for the connections and amounts is printed out only on the last page.

If all the complete reports are printed out at the same time, the printout is made in the following order:

- User Private
- User Business
- Room extensions (Hotel system only)
- Cost centres
- Network interfaces

```

***** any text (max. 68 characters configurables) *****
CALL FEES          FROM 30.07.04 18:00  SERVICE INCLUDED  1822
User              VOICE+DATA CALLS, PRIVATE

NUMBER  STATE  RECORD   SINCE   CALLS    FEE IN EURO
20      .       01.07.04 18:05   104     521.10
21      B       03.07.04 18:05   27      278.10
.       .       .         .       .       .
43      *       02.07.04 18:05   23      278.10
    
```

Fig. 136 Complete report for private calls made by all users

```

NUMBER  STATE  RECORD   SINCE   CALLS    FEE IN EURO
44      .       01.07.04 14:45   83      405.00
.       .       .         .       .       .
691     B*      14.07.04 22:10   2        8.90
.       .       .         .       .       .
TOTAL   .       .         .       763     3216.30
    
```

Fig. 137 New page (appears after a page break)

```

***** any text (max. 68 characters configurables) *****
CALL FEES          FROM 27.06.04 18:00  SERVICE INCLUDED  0040
User              VOICE+DATA CALLS, PRIVATE

NUMBER  STATE  RECORD   SINCE   CALLS    FEE IN EURO
20      .       27.05.04 13:00   4        12.20
21      .       27.05.04 13:00   2        4.20
.       .       .         .       .       .
29      *       27.05.04 13:00   123     213.80
.       .       .         .       .       .
TOTAL   .       .         .       412     529.40
    
```

Fig. 138 Complete report for business data connections

***** any text (max. 68 characters configurables) *****					
CALL FEES		FROM 30.07.04 18:00			1822
EXCH. LINES					
EXCH	STATE	RECORD	SINCE	CALLS	FEE IN EURO
2.1		01.07.04	18:05	4	21.10
2.2		27.05.04	13:00	27	78.30
3.1.		.	.	68	278.30
.		27.05.04	13:00	.	.
0.2		14.07.04	22:10	824	848.90
.			TOTAL	2763	4213.20

Fig. 139 Complete report for all network interfaces

8.3 Call logging for outgoing calls (OCL)

OCL is used to log the outgoing connection data of individual calls and output the data via the system's corresponding interface at the end of the call. OCL can be activated and deactivated throughout the system and for each user.

Output formats

The output formats PC1...PC5 are available for output on a PC.

For the output on a printer there is a choice of a list output (protocol) or an individual receipt output (for each call one multi-line receipt with additional text).

With the *OIP* format, the call data can be sent to a OIP server and further processed there.

Only the output formats protocol and individual receipt are subject to the surcharge calculator allocated to the user.

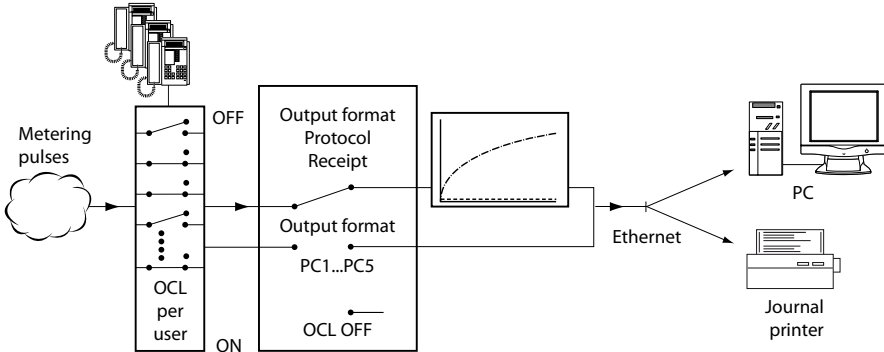

Fig. 140 Schematic sequence



See also:
"Output formats", page 286.)

8. 3. 1 General OCL settings

Activating OCL throughout the system

Allocating the required output format in the system configuration automatically activates OCL.

Tab. 99 User-related settings

OCL	The online output can be switched on and off for each user.
Surcharge calculator	One of four possible surcharge calculators can be allocated in each case for business and private calls.

Tab. 100 Printout as of a specific charge value

Output	As of
Business	...5.00...
Private	...0.10...
Cost centres	...0.10...
Room	...0.10...

The call charges are printed out only once the set values are exceeded.

The ICC, however, logs all the call charges and allocates them to the cumulative counters.



Aastra Intelligent Net:

In an AIN the charge values as of which a printout is made can be adapted specifically for each node using the AMS Configuration Manager. Please note that the values throughout the AIN are indicated in the same currency, defined throughout the system (see also AIN note on page 268).

Digit barring if output is blocked

If for whatever reason the printer cannot print or the PC cannot receive data (see "Printer faults", page 285), the next calls are stored internally in the communication server. After that, the selected digit barring (e.g. 1) becomes active. Then only the numbers enabled by the digit barring can be dialled.

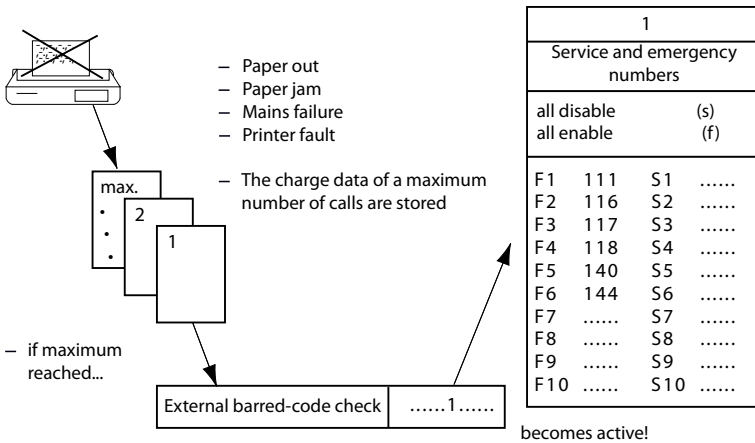

Fig. 141 Situation if output is blocked

8.3.2 Surcharge calculator

The surcharge calculator is used to assess surcharges on top of the official call charges.

Four independent surcharge calculators can be configured and allocated to the cumulative counters of the users or rooms. Call charges are indicated to each user (only on system phones with a display) while the call is in progress. If the user has been allocated a surcharge calculator, the call charges displayed include surcharges.

The cost curve of a surcharge calculator is defined by the basic surcharge and 4 cost ranges.

For each of the 4 ranges the user can specify a factor with which the call charges in the corresponding range limits are multiplied.

The basic surcharge is added to every chargeable call. If the basic surcharge is to be applied only as of, say, –.20, the following settings are necessary:

Range 1: surcharge factor 0; start of range 2: –.20.

This means, for example, that a hotel guest will only be charged for a call as of the second metering pulse.

Call charges on cost centres allocated to network interfaces or call distribution elements are never adapted via the surcharge calculator.

No surcharge calculators are configured after an initialization.

Application Example

Tab. 101 Example: A user incurs 30.- in call charges. He pays 61.50.

Surcharge ranges	Network call charges			Surcharge		Call charge invoiced
	from	to	Amount	Factor	Charge per range	Display Charge counters
Basic surcharge	–	–	–	–	2.–	2.–
Range 1	0	10.–	10.–	X 3	= 30.–	32.–
Range 2	10.–	15.–	5.–	X 2	= 10.–	42.–
Range 3	15.–	20.–	5.–	X 1,5	= 7.50	49.50
Range 4	20.–	End value (here 30.–)	10.–	X 1.2	= 12.–	61.50

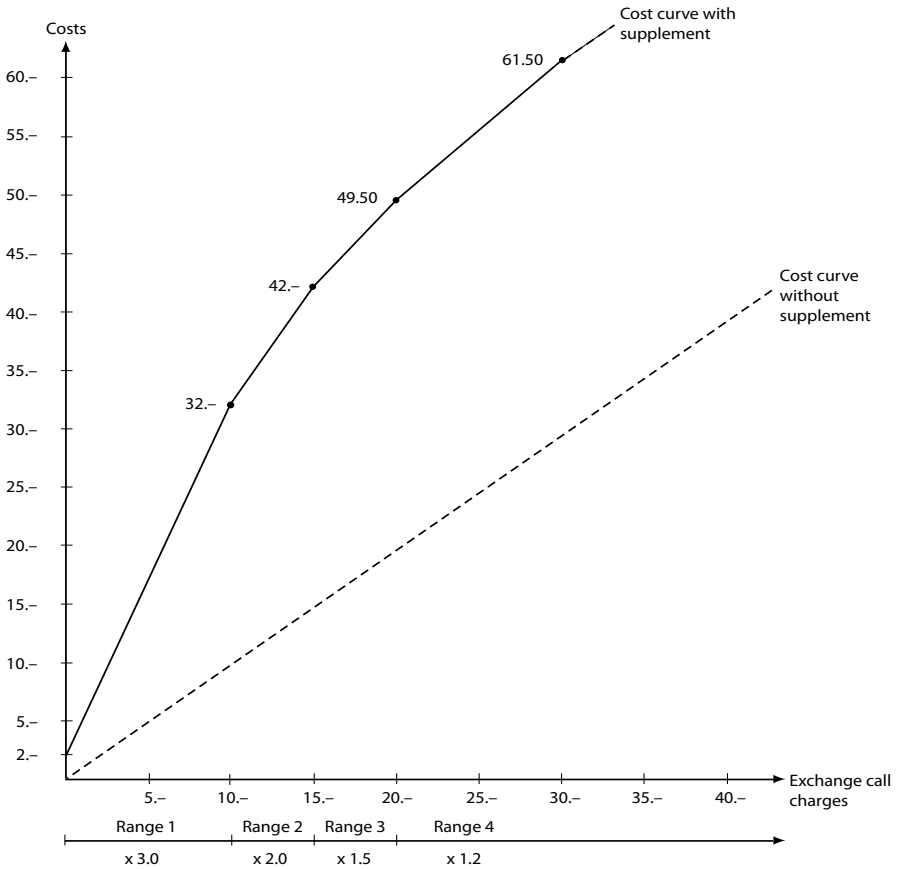

Fig. 142 Cost curve for the application example



See also:

System configuration:

- OCL/ICC/ICL
- OCL; user configuration
- Charge pulse; User configuration
- OCL; only on connection
- Report; OCL/ICC/ICL
- Surcharge calculator; OCL/ICC/ICL parameters

8.3.3 Data protection

The system offers the option to activate data protection, i. e. to blank out on the printout the last 4 digits of the number dialed (Fig. 143). Data protection can be activated separately for business and private calls.

8.3.4 Cost centres

There are 100 cost centres (00 – 99) available. A cost centre can be allocated either permanently or for individual calls only (variable).

Permanent allocation

A cost centre can be permanently allocated to each user and to each call distribution element. Any given cost centre can also be allocated to several users or call distribution elements.

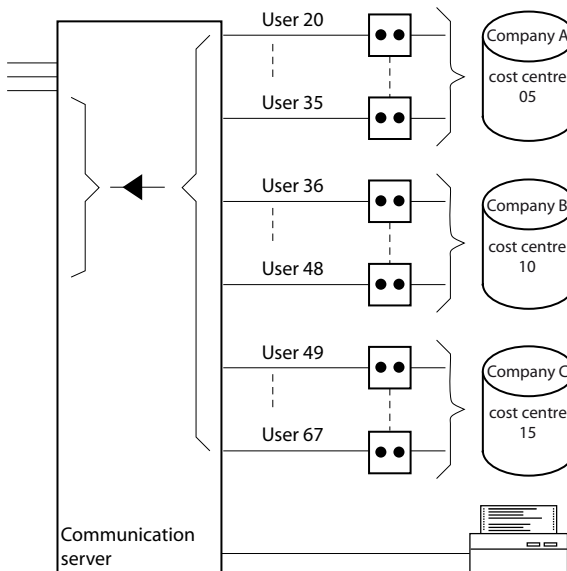

Fig. 143 Permanent cost centre allocation



Note:

Permanently allocated cost centres are not processed / logged in OCL (ICC only).

Variable allocation

Individual calls can be assigned to a cost centre either before the call by dialling the exchange access prefix code for cost centre selection or during the call using a */# function code. With line keys, variable cost centre allocation is possible only using a */# function code.

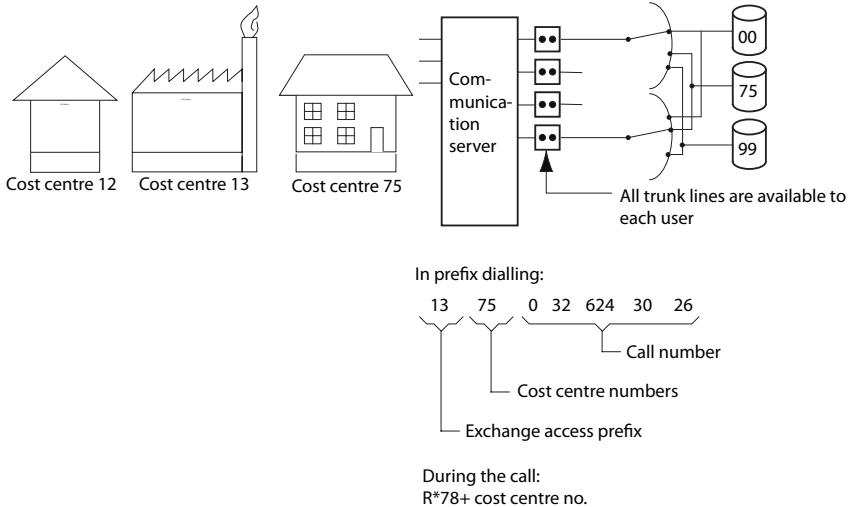

Fig. 144 Variable cost centre allocation

Surcharge calculator

If a user has been allocated a surcharge calculator, the call charges are first adjusted with the surcharge calculator before being charged to the allocated cost centre. The call charges logged on a call distribution element are always charged directly, without changes, to the allocated cost centre.

External cost centres

The call charges for individual calls can also be charged to external cost centres (variable allocation). External cost centres must have a two to nine-digit number. They are entered in a data field of an output format and can be analysed using a call data application.

8.3.5 Charge management

If an external call is forwarded internally, the charges incurred can be passed on to the next user. This feature can be activated and deactivated throughout the system and applies only locally in the PINX. User A is making an outside call. After a while he hands the call over to user B.

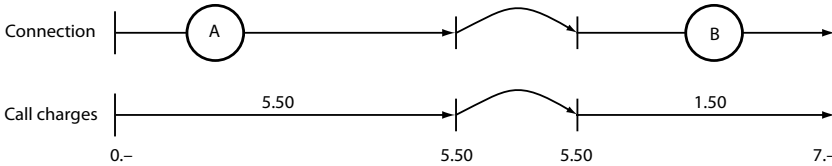

Fig. 145 Handing over the call charges from user A to user B

If charge management is switched on, the charges incurred by user A during the call are passed on to user B when the call is handed over. User A therefore does not incur any charges.

The total amount of 7.- is charged to user B on the ICC and the OCL.

If charge management is switched off, an intermediate statement is drawn up for user A when the call is handed over. It contains the charges incurred by user A up to the point at which the call is passed on (5.50). This means that user B incurs only those charges levied from the point at which the call is handed over to him (1.50).

On the operator console, call charges are always passed on to the next user irrespective of whether or not charge management has been configured.



See also:

System configuration:

- Charge management; OCL/ICC/ICL parameters.

8.4 Call logging for incoming calls (ICL)

ICL deals with the logging of incoming call data. The ICL data can be used for example to analyse how quickly calls are handled, how many calls are lost because they are not answered quickly enough or not transferred successfully, or at what times a particularly large number of outside calls are received.

The data actually output in each individual case depends on the selected output format (see "Output formats", page 286).

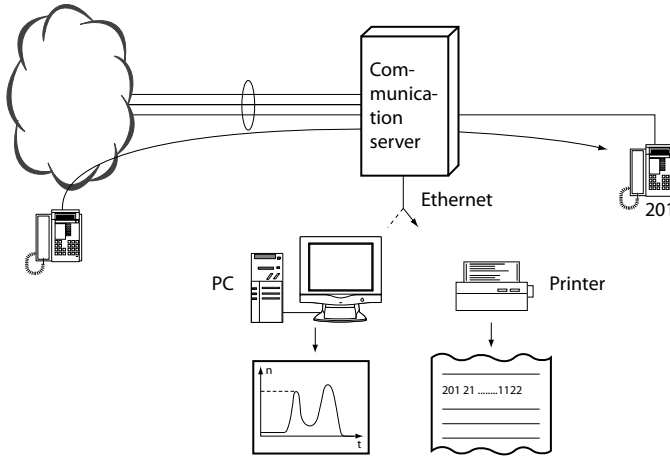

Fig. 146 Incoming call logging

ICL can be switched on or off for each call distribution element.

Sort characters are used to differentiate between data and call connections and between answered, transferred and unanswered calls.

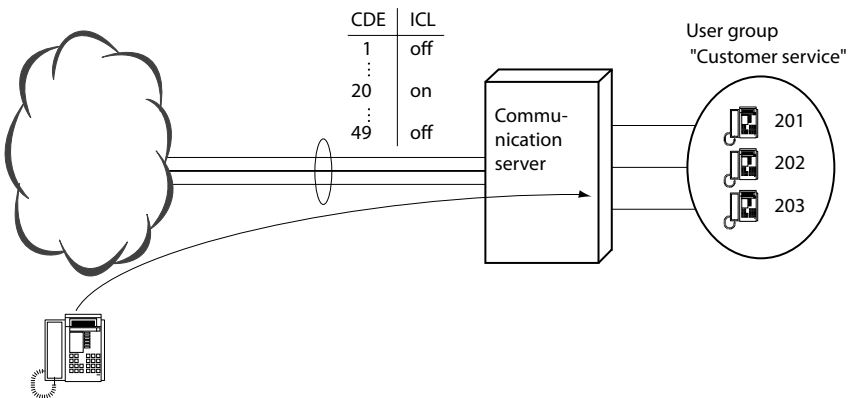

Fig. 147 ICL can be switched on or off in each call distribution element

Application Example

- Customer service: 032 655 33 33
- *ICL ON*, for customer service calls only (see Fig. 147).

Analysis is used to determine the quality of the call handling. One possible result of the analysis is that customer service is constantly busy between 10 a.m. and 11 a.m., and that an extra employee might be required during that period.

Cost centre allocation

It is possible to allocate a cost centre to an incoming call using the *78 + CC No. function code. Businesses such as lawyers, physicians, consultants, etc., like to invoice their consultancy fees on the basis of the duration of the calls made with their clients. In such cases, ICL is combined with cost centre allocation.

Response if output is blocked

(See ["Printer faults", page 285.](#))

ICL and OCL: Areas of conflict

ICL can lead to conflicts with OCL as the same resources are used in part. Critical points are:

- Same output channel:
A certain amount of ambiguity can arise between OCL and ICL if clear sorting is not carried out. Under certain circumstances the equipment used for charge acquisition may have to be reconfigured.
- Separate protocols:
ICL and OCL protocols can be configured independently of each other.
- Memory overflow:
- Ambivalence with transfer traffic:
If external calls are transferred or rerouted to an external destination and then answered there, 2 protocol lines will be generated (if both OCL and ICL are enabled).
- Two-company system:
ICL does not support separate logging according to company.

8.5 Call data output

The ICL, OCL and ICC data is output on printers or other output devices via the Ethernet interface. It is possible to configure which data is output on which of the available interfaces. Up to 4 output devices can be connected at the same time.

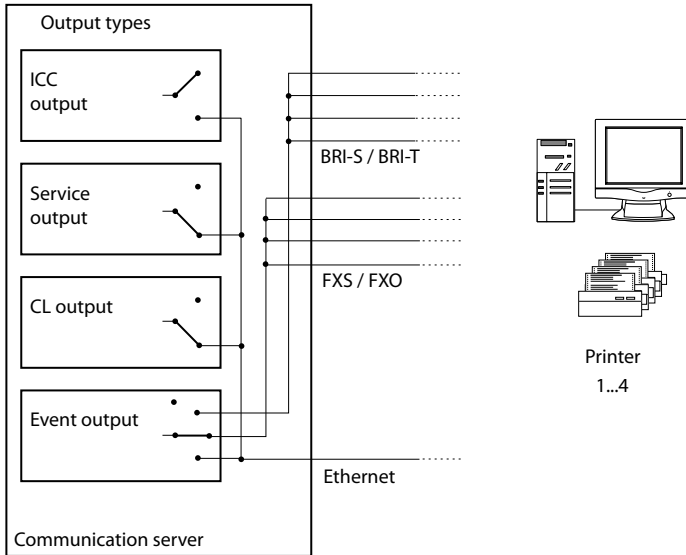

Fig. 148 Output concept



See also:

The call data can also be accepted and processed further by OIP. For more details please refer to the "Open Interfaces Platform" system manual.

8.5.1 Output types

The output type depends on who triggered the output. The output types are as follows:

Output type *ICC output*

- Output at user's request, e.g. using a command on the operator console
- ICC counter readings and reports (e.g. hotel check-out)

Output type *Service output*

- Output at user's request, e.g. using a command on the operator console
- System configuration data
- Event message list
- Plus, for hotel:
 - Wake-up lists
 - Room status list

Output type *CL output*

- Output triggered by the system (e. g. when call charges are incurred)
- OCL journal printouts (online)
- ICL journal printouts (online)

Output type *Event output*

- Output triggered by the system
- System events such as:
 - Synchronization loss
 - External message destination unobtainable

Number of output devices

Up to 4 printers or output devices can be connected to the system.

If only 1 output device is connected, it will carry out all the output jobs. In normal operation it handles the *CL printer* job (ICL and OCL output). If the output is triggered from somewhere else the output type is altered at short notice. If a *CL output* job is followed by an *Event output* job, the new job will be separated by a line of asterisks *. If the printout of the new job is to begin on a new page, a manual printer formfeed is to be performed beforehand.

Output when used in a hotel

When determining the output concept, remember to take note of the comments in "[Configuration and operating concept](#)", page 505.

Setting the page length

In principle, the page length can be set individually for all output types. If, however, only one output device is connected, the page length set for *Service printer* output type will apply.

8.6 Printer faults

If it is not possible to print on the CL printer for at least one minute (e.g. paper out), an event message will be triggered in the communication server. If the interruption can be remedied immediately, there are no further repercussions, as the call data is stored temporarily in a buffer. After a specific number of calls, emergency digit barring is activated. The emergency digit barring affects all users throughout the system, with the exception of the operator console. This feature restricts the dialling options in the event of a printer jam. Once the fault is remedied, normal digit barring is activated once again.

Tab. 102 Buffering when output is blocked

Call	Call data
1	A corresponding event message is generated
.	ICL data is buffered
.	OCL data is buffered
.	
50%	
.	OCL data is buffered
.	ICL data is no longer buffered
.	
.	
max.	
max. +1	Emergency digit barring is activated
.	
.	
.	



Note:

The communication server can only detect printer faults if the printer is operated with RTS/CTS DSR/DTR flow control (hardware handshake mode).

8.7 Output formats

An output format defines which call data is to be output in which format. The following output formats are available:

Formats PC1 to PC5

Used for output on a PC. The PC5 format is the most comprehensive PC format and is recommended for all systems upgraded with a new PC application for the acquisition and evaluation of call data. The PC5 format contains ICL and OCL data (see [page 286](#)).

Formats PC1 to PC4 are still supported for PC applications that are already in operation. However, these formats are not suitable for PINX in a private network. There is a separate ICL and OCL variant for each of the formats PC1 to PC4 (see [page 312](#)).

Protocol format

This format is used for output on a printer. It does not contain all the data of the PC formats. There is a separate ICL and OCL variant for the Protocol format (see [page 308](#)).

Individual receipt format

This format is used to print out individual call charges as a receipt. The individual receipt format is available for OCL only (see [page 311](#)).

Output format OIP

The OIP format is used for sending call data from the communication server to the OIP server. The format is based on the PC5 format but contains additional information. On the OIP side, the Call Logging Driver (internal OIP service) is the interface adapter for accessing the charge data interface. For detailed information, please refer to the Open Interfaces Platform System Manual.

8.7.1 Structure of the PC5 output format

The PC5 format is used to output incoming and outgoing call data (ICL and OCL) on

- stand-alone communication servers
- PINX in private networks.

It is the most comprehensive PC format and is generally recommended when upgrading with a new PC application for the acquisition and evaluation of call data.

The data is output in ASCII format in data fields. The data fields have a fixed field length. All the data fields together form a data record. The data record begins with a Tab and ends with a Carriage Return and Line Feed. These control characters are output with hexadecimal values as per [Tab. 103](#).

Tab. 103 Control characters for separating data fields and data record

Designation	Meaning	Hexadecimal value	Usage
HT	Horizontal tab	09	Start of data record
CR	Carriage Return	0D	Together at the end of a data record (CR plus LF)
LF	Line Feed	0A	

A data field contains the following information:

- Data field name
- Data format
- Data field formatting
- The data field length

A data field can be identified by its position in the data record ([Tab. 106](#)).

Data field name

In PC5 format the data field name is not output.

Data format

A data field consists of a certain number of characters and a specific data format. [Tab. 104](#) shows the symbols used for describing the data fields in [Tab. 106](#).

Tab. 104 Symbols used to describe the data format

Symbol	Meaning	Number of characters
i	Integers	see "Length" in Tab. 106
d	Decimal figures	see "Length" in Tab. 106
yymmdd	yy = year, mm = month, dd = day	3 x 2 characters
hh:mm	hh = hours, mm = minutes	2 x 2 characters
hhHmMss	hh = hours, mm = minutes, ss = seconds, H = "H", M = "M"	3 x 2 characters
cbbpp	c = primary channel group, bb = trunk card number, pp = network interface number	1+2+2 characters

Data field formatting

A data field can be formatted to be right or left justified and padded with leading numbers or blank spaces. [Tab. 105](#) shows the symbols used to describe the data fields in [Tab. 106](#).

Tab. 105 Symbols used for describing the data field formatting

Symbol	Meaning
I-	Left justified
-I	Right justified
0	Padded with "0" up to the permanently defined data field length
SP	Padded with spaces up to the permanently defined data field length

Data field length

The length of a data field can be permanently defined or remain variable up to a maximum length.

8. 7. 2 Data fields of the PC format

[Tab. 106](#) shows the complete data record of a PC5 output. The data fields are listed in their task sequence.

Tab. 106 PC5 format

Data field	Name	Data format	Formatting	Length	Offset
Start of data record:					
Horizontal tab (HT)				1	0
User number	NO	i	SP -I	12	1
Cost centre number	CC	i	SP -I	9	14
Sort character	SC	i	0 -I	3	24
Date of start of connection	DATE	yymmdd	0 -I	6	28
Time of start of connection	TIME	hh:mm	0 -I	5	35
Duration of connection	DURATION	hhHmmMss	0 -I	8	41
Call charges	CHARGES	ddddddd.dd	SP -I	10	50
Number of metering pulses	METPUL	i	0 -I	5	61
Channel group / trunk card / network interface number	EXCH	cbbpp	0 -I	5	67
Caller identification 1	ID1	i	SP -I	20	73
Caller identification 2	ID2	i	SP -I	20	94
Destination number 1	DEST1	i	SP -I	40	115
Destination number 2	DEST2	i	SP -I	40	156

Data field	Name	Data format	Formatting	Length	Offset
Time-To-Answer	TTA	i	0-1	3	197
Sequence number	SEQ.NO.	i	0-1	3	201
Serial number	SERIAL NO.	i	0-1	4	205
Carriage Return (CR)				1	209
Line Feed (LF)				1	210

8.7.2.1 Explanation of the data fields

User number

Outgoing:

- Entry for the caller's user number.
- Entry for source PINX and stand-alone communication server; otherwise the data field remains empty.

Incoming:

- Contains an entry for destination PINX and stand-alone communication server; otherwise the data field remains empty.
- Unanswered call:
The number for the internal destination address is entered here. It can be a user group (UG), a key telephone (KT), a user (US) or a combination of these addresses.
The user number is entered under US and the combinations US+UG or US+KT. The UG number is entered here for UG and the combination UG+KT, where configured. If not, the configured ICL initialization number is entered, as with the KT setting.
- Answered call:
Enters the number of the caller who took the external call or rerouted it externally.
- Transferred call:
If the call was transferred internally or externally, the transferred user is entered.

Cost centre number

- Entry for the variable cost centre (see "[Cost centres](#)", page 278).
- In the PISN the cost centre is logged only in the PINX in which the variable cost centre selection was carried out.

Sort character

The three-digit sort character xyz is used for identifying a data record. It is used to make the following distinctions:

Tab. 107 Meaning of the digits used in the sort character

Digit	Meaning
x	Destination/source network and connection direction
y	Type of network access/exchange-to-exchange connections
z	Call handling

Tab. 108 Value and meaning of the digit x

Value	Meaning
0	Outgoing to the public network
1	Outgoing to the PISN
3	Incoming from the public network
4	Incoming from the PISN

Tab. 109 Value and meaning of the digit y

Value	Meaning
0	Business network access, transferred
1	Business network access, self dialling
2	Incoming (appears only at the destination PINX)
3	Incoming to ACD destination (placed in ACD queue)
4	PISN transit
6	Network access with cost centre selection, transferred
7	Network access with cost centre selection, self dialling
8	Private network access, transferred
9	Private network access, self dialling

Tab. 110 Value and meaning of the digit z

Value	ICL	OCL
0	Incoming call, transferred	Normal call
1	Incoming call, answered directly	–
2	Unanswered call	–
3	Answered call. Appears only if 0 or 1 does not apply.	–
4	Incoming call connection, transferred to the network	Transfer call, set up through CFU / CFNR / CD into the network
5	–	Transfer call, transferred by internal user
6	Incoming data service connection	Outgoing data service connections

Value	ICL	OCL
7	-	Outgoing connections on phone booth extensions
8	-	Outgoing connections on room extensions
9	Rejected connection with destination <ul style="list-style-type: none"> • ERC (external remote control) • ACD (ACD queue) 	

Tab. 111 Examples of sort characters

Sort character	Meaning
010	Outgoing connection to the public network, business network access, self dialling
160	Outgoing connection to the PISN, network access with cost centre selection, transferred
170	Outgoing connection to the PISN, network access with cost centre selection, self dialling
176	Outgoing data service connection to the PISN, network access with cost centre selection, self dialling
140	Outgoing connection to the PISN, transit
322	Incoming connection from the public network to the destination PINX, unanswered
324	Incoming connection from the public network to the destination PINX, transferred to the public network
443	Incoming connection from the PISN, transit, answered
420	Incoming connection from the PISN, transferred
421	Incoming connection from the PISN, answered directly

Tab. 112 Example of the output type CL printer in PCS format

NO	CC	SC	DATE	TIME	DURATION	CHARGES	METPUL	EXCH
50250		321	180598	14:56	00H01m12			00101
		343	180598	14:57	00H02m05			00102
		140	180598	15:05	00H10m35			00103
50001		321	180598	15:20	00H01m12			00201

ID1	ID2	DEST1	DEST2	TTA	SEQ.NO.	SERIAL NO.
0222222200	022222222		50	0023	014	1236
0333330000	033333333		54	0012	015	1237
0333330000	0333330000	50301	54			1238
0333330000	0333330000		50301	0012	007	1239

Date and time of start of connection

- Entry for the time of the start of connection on the logging communication server or in the PISN.
- In the case of forwarded calls the time logged is the time as of which the transferred call begins.

Duration of connection

- Entry for the duration of a connection by the logging communication server or PINX.
- The entry for unanswered calls is 0.

Call charges

- In the case of an ISDN connection, the call charge information supplied with the call is entered here.
- In the case of an analogue connection, the metering pulses are converted and entered.

Metering pulses

- In the case of an ISDN connection, the call charge information supplied with the call is converted and entered.
- In the case of an analogue connection the metering pulses are entered.

Network interface number

The primary channel group "0" is output in position "c", the trunk card number in position "bb" and the network interface number in position "pp".

Example:

00201 Trunk card in system slot 2. Network interface 1.

00504 Trunk card in system slot 5. Network interface 4.

Caller identification 1 and caller identification 2

These fields have a different meaning depending on the direction (incoming or outgoing calls).

- Caller identification 1, incoming:
The number which the calling user wants to present to the called user is entered here. This number is displayed as CLIP on system phones.
- Caller identification 2, incoming:
A call number from the calling user that has been verified by the network provider and found to be valid is entered here.

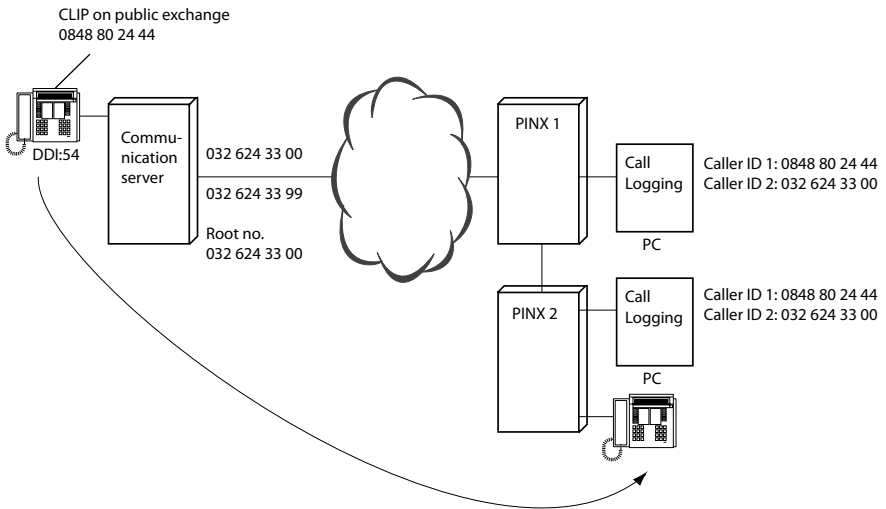

Fig. 149 Caller identification incoming

- Caller identification 1, outgoing:
On the OCL report at the gateway/transit PINX: The user call number valid within the network is entered here.
On the OCL report at the source PINX no number is entered in this field.
- Caller identification 2, outgoing:
On the OCL report at the source/transit PINX: The user call number valid within the PISN is entered here.
On the OCL report at the gateway PINX: The user's DDI number is entered here.

On a stand-alone communication server the entries are output analogue to a source PINX.

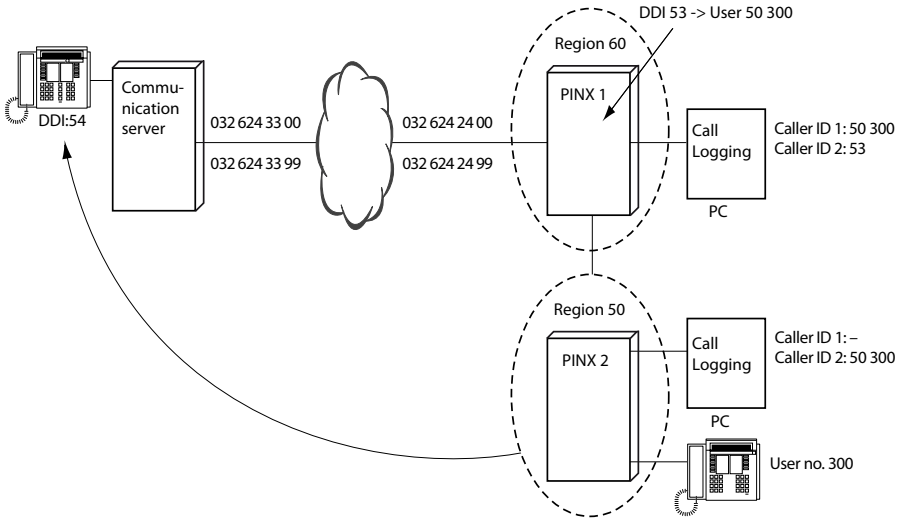

Fig. 150 Caller identification outgoing

Destination number 1 and destination number 2

These fields have a different meaning depending on the direction (incoming or outgoing calls).

- Destination number 1, incoming:
 - For incoming calls: no entry.
 - For calls to the DDI number for external remote control: Enter the instruction sequence selected in DTMF mode.
- Destination number 2, incoming:
 - For the gateway PINX and the stand-alone communication server: Enter the destination number received from the network provider (e.g. Direct dialing number).
 - For the transit and destination PINX: The PISN user number of the called user is entered here.

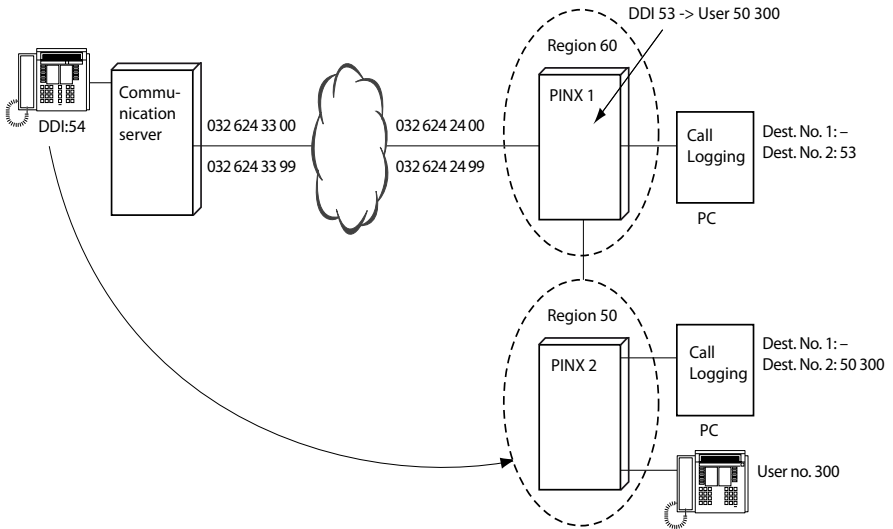

Fig. 151 Destination number incoming

- Destination number 1, outgoing:
Entry for the call number dialled by the PINX or by the communication server. Depending on the LCR configuration this call number may differ from the call number dialled by the user.
- Destination number 2, outgoing:
The call number dialled by the user is entered here.

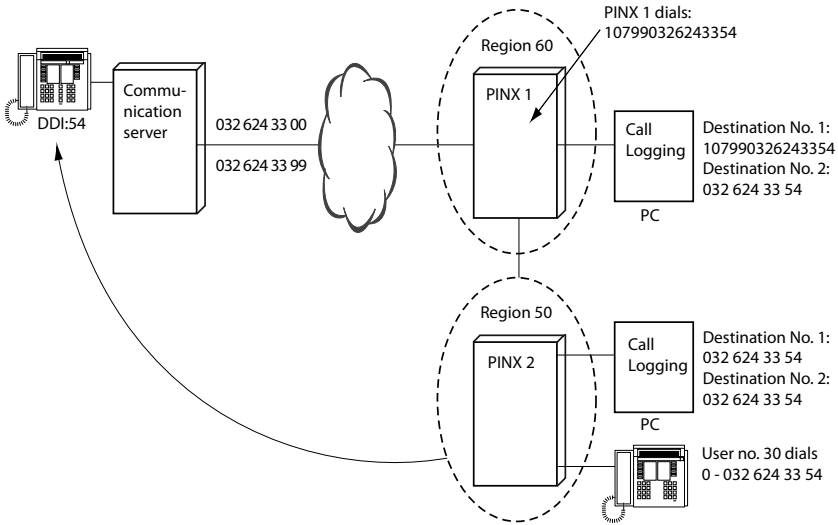

Fig. 152 Destination number outgoing

Time To Answer (TTA response time)

In the case of calls transferred internally the call time is logged with the transferred user. The amount of time from the start of the ringing phase to the answering of a direct call is entered here (in seconds).

In the case of unanswered calls the ringing time is logged. Rejected calls are given TTA = 0.

Sequence number

Transferred calls have the same sequence number but separate serial numbers. Each incoming call is allocated a sequence number. However, since not all calls are necessarily logged (logging may be deactivated individually per network interface or call distribution element), the numbering is not necessarily continuous.

Serial number

The serial number is incremented by 1 each time an incoming or outgoing call is logged.

- After initialization the serial number is reset to the value 0.
- The serial number is not reset after a normal start.
- The serial number cannot be set manually.

8. 7. 3 Examples of the PC5 output on a stand-alone communication server

8. 7. 3. 1 Outgoing calls to the public network

A business call is set up with the public network using self dialling. The digit sequence 010 is therefore entered as the sort character. Least Cost Routing function is deactivated.

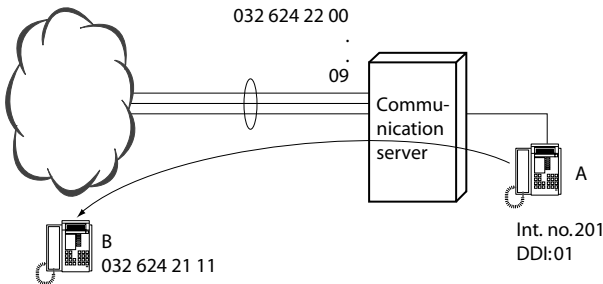

Fig. 153 Outgoing call to the public network

Tab. 113 OCL output for an outgoing call to the public network

NO	CC	SC	DATE	TIME	DURATION	CHARGES	METPUL	EXCH
201		010	060798	10:20	00H14M05	1.00	00010	00101

ID1	ID2	DEST1	DEST2	TTA	SEQ.NO.	SERIAL NO.
	01	6242111	6242111			0001

8. 7. 3. 2 Incoming calls from the public network

Answered calls

All answered calls have a call duration greater than 0. The *Time* and *Date* fields indicate when the call was set up. The *TTA* field specifies the duration of the ringing phase. The sort character is 321.

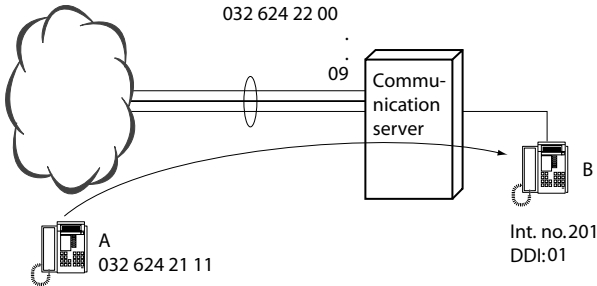

Fig. 154 Call to a free user and phone conversation

- User A (032 624 21 11) calls user B (032 624 22 01).
- User B’s terminal rings.
- User B answers the call.
- User A talks to user B.
- At the end of the conversation the call is ended by the two users.

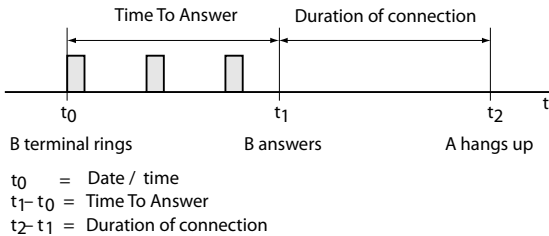

Fig. 155 Duration of ringing phase and established connection

Tab. 114 ICL output for an answered incoming call

NO	CC	SC	DATE	TIME	DURATION	CHARGES	METPUL	EXCH
201		321	020798	10:24	00H01M12			00101

ID1	ID2	DEST1	DEST2	TTA	SEQ.NO.	SERIAL NO.
0326242111	0326242111		01	005	55	0114

Unanswered calls

0 is entered in the *Duration* field in the case of unanswered calls. The *Time* and *Date* fields indicate the time at which the call was received. The sort character is 322. The time entered in the *TTA* field indicates how much time elapsed before the caller hung up.

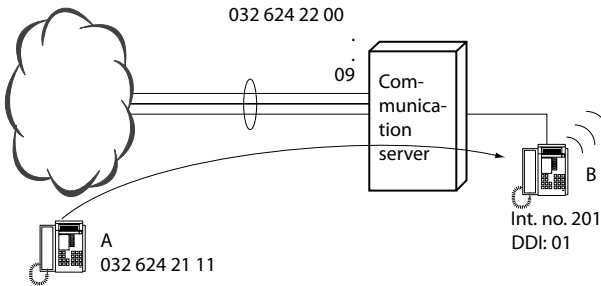

Fig. 156 Call to an absent user

- User A (032 624 21 11) calls user B (032 624 22 01).
- User B does not answer.
- User A hangs up.

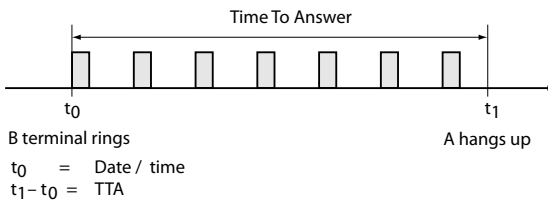

Fig. 157 Duration of the TTA ringing phase

Tab. 115 ICL output for an unanswered incoming call

NO	CC	SC	DATE	TIME	DURATION	CHARGES	METPUL	EXCH
201		322	020798	10:20	00H00M00			00101

ID1	ID2	DEST1	DEST2	TTA	SEQ.NO.	SERIAL NO.
0326242111	0326242111		01	020	53	0112

Calls to a busy User

If a busy user is called while protected against call waiting, 0 is entered in the *Duration* field. The *Time* and *Date* fields indicate when the call was received. The sort character is 322. Time To Answer is 0.

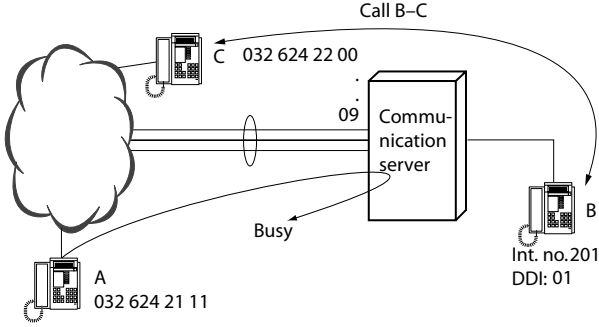

Fig. 158 Call to a busy user

- User B is busy (call with call waiting not enabled).
- User A (032 624 21 11) calls user B (032 624 21 01).
- User A hears the busy signal.

Tab. 116 ICL output for a call to a busy user

NO	CC	SC	DATE	TIME	DURATION	CHARGES	METPUL	EXCH
201		322	020798	10:22	00H00M00			00101

ID1	ID2	DEST1	DEST2	TTA	SEQ.NO.	SERIAL NO.
0326242111	0326242111		01	000	54	0113

Transferred call

If a call was transferred to another user, the subsequent ICL handling will depend on the charge management configuration.

Transferred call, charge management deactivated

The transferred phase of the connection is logged on a separate ICL. The call initially answered is given sort character 321. The sort character for the second ICL line is 320.

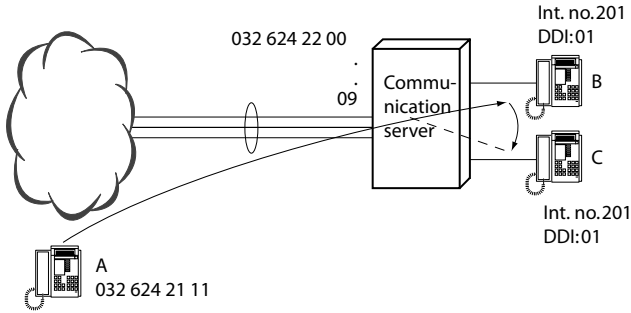

Fig. 159 Transferred call

Without prior notice:

- User A (032 624 21 11) calls user B (032 624 22 01).
- User B’s terminal rings.
- User B answers the call.
- User A talks to user B.
- User B activates an enquiry call to user C
- User B hangs up.
- User C’s terminal rings.
- User C answers the call.
- User A talks to user C.
- At the end of the conversation the call is ended by the two users.

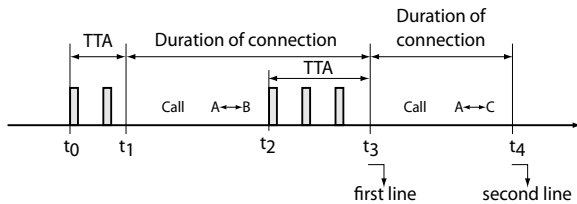

Fig. 160 Time phases for a transferred call without prior notice

Tab. 117 ICL output for a transferred call without prior notice

NO	CC	SC	DATE	TIME	DURATION	CHARGES	METPUL	EXCH
201		321	020798	10:26	00H01M00			00101
202		320	020798	10:27	00H12M03			00101

ID1	ID2	DEST1	DEST2	TTA	SEQ.NO.	SERIAL NO.
0326242111	0326242111		01	004	56	0115
0326242111	0326242111		01	006	56	0116

With prior notice:

- User A (032 624 21 11) calls user B (032 624 22 01).
- User B’s terminal rings.
- User B answers the call.
- User A talks to user B.
- User B activates an enquiry call to user C
- User B does not hang up.
- User C’s terminal rings.
- User C answers the call.
- User B talks to user C.
- User B hangs up.
- User A talks to user C.
- At the end of the conversation the call is ended by the two users.

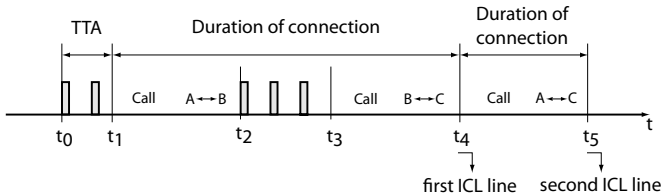

Fig. 161 Time phases for a transferred call with prior notice

Tab. 118 ICL output for a transferred call with prior notice

NO	CC	SC	DATE	TIME	DURATION	CHARGES	METPUL	EXCH
201		321	020798	10:26	00H01M00			00101
202		320	020798	10:27	00H12M03			00101

ID1	ID2	DEST1	DEST2	TTA	SEQ.NO.	SERIAL NO.
0326242111	0326242111		01	004	57	0117
0326242111	0326242111		01	000	57	0118

Transferred call, charge management deactivated

The entire call is logged in a single line. The connection duration is entered in the *Duration* field. The *No.* field contains the user number of the last user in the call. The sort character is 320.

Tab. 119 ICL output for a call to a busy user

NO	CC	SC	DATE	TIME	DURATION	CHARGES	METPUL	EXCH
202		320	020798	10:26	00H13M03			00101

ID1	ID2	DEST1	DEST2	TTA	SEQ.NO.	SERIAL NO.
0326242111	0326242111		01	007	58	0119

8.7.4 Examples of PC5 output in a PISN

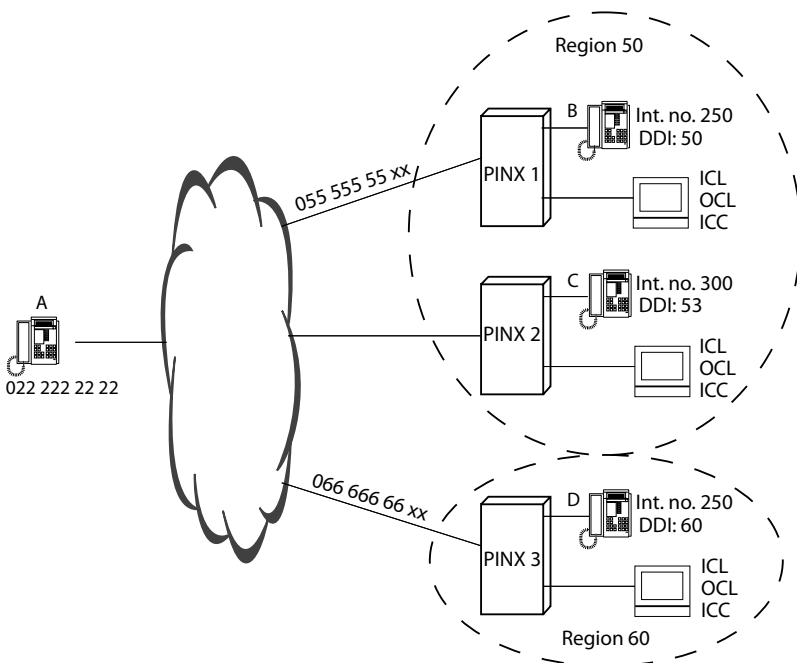

Fig. 162 PISN with two regions and shared numbering plan for Region 50

Tab. 120 Configuration of the PISN above

Numbering plan for	Separate prefix code	Internal (local) users	PISN users
PINX 1	50	200...299	3xx, 60xxx
PINX 2	50	300...399	2xx, 60xxx
PINX 3	60	200...299	50xxx

The following examples are based on this PISN.

Direct outgoing connection

A connection is set up directly to the public network using self dialling (cost type: business).

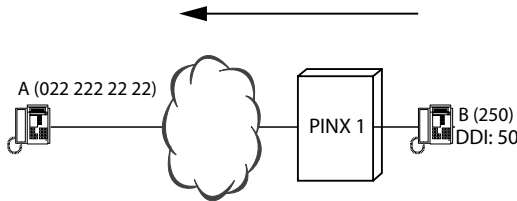

Fig. 163 User B dials user A (0 022 222 22 22)

Tab. 121 OCL output on PINX 1

NO	CC	SC	DATE	TIME	DURATION	CHARGES	METPUL	EXCH
50250		010	180598	14:50	00H02m10	0.20	00002	00102

ID1	ID2	DEST1	DEST2	TTA	SEQ.NO.	SERIAL NO.
	50	0222222222	0222222222			123

- NO PISN number of user B.
- SC Outgoing call to the public network. Self dialling network access, business.
- ID1 Nothing is entered here as PINX 1 is both the source and gateway PINX.
- ID2 Direct dial number via which user B can be reached directly from the public network.
- DEST1, DEST2 The number dialled by the user (DEST2) was forwarded unchanged by the PINX (DEST1) since LCR is not activated.

Outgoing connection via a gateway PINX

A connection is set up to the public network via a gateway PINX using self dialling (cost type: business).

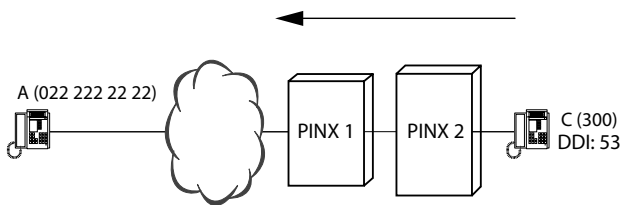

Fig. 164 User C dials user A (0 022 222 22 22)

Tab. 122 OCL output on PINX 2 (source PINX)

NO	CC	SC	DATE	TIME	DURATION	CHARGES	METPUL	EXCH
50300		010	180598	14:50	00H03m05	0.00	00000	00103

ID1	ID2	DEST1	DEST2	TTA	SEQ.NO.	SERIAL NO.
	50300	0222222222	0222222222			5677

NO PISN number of user C.

SC Outgoing call to the PISN. Self dialling network access, business.

CHARGES, METPUL 0 is entered here as the charges are incurred at PINX 1 and are not forwarded to PINX 2.

ID1 Nothing is entered here as PINX 2 is the source PINX.

ID2 PISN number of user C.

DEST1, DEST2 The number dialled by user C (DEST 2) is forwarded unchanged by PINX 1 (DEST 1) since LCR is not activated.

Tab. 123 OCL output on PINX 1 (gateway PINX)

NO	CC	SC	DATE	TIME	DURATION	CHARGES	METPUL	EXCH
		040	180598	14:51	00H03m05	1.50	00015	00104

ID1	ID2	DEST1	DEST2	TTA	SEQ.NO.	SERIAL NO.
50300	53	10707022222222	0222222222			1235

NO Nothing is entered here as the caller is not a PINX 1 user.

SC Outgoing exchange-to-exchange call to the public network.

CHARGES, METPUL The call charges are entered here.

- ID1 PISN number of user C.
- ID2 DDI number via which user C can be reached from the public network.
- DEST1, DEST2 The number dialed by the user (DEST2) was converted into another call number (DEST1) by the LCR function. This is the number actually dialed by PINX 1.

Direct incoming call

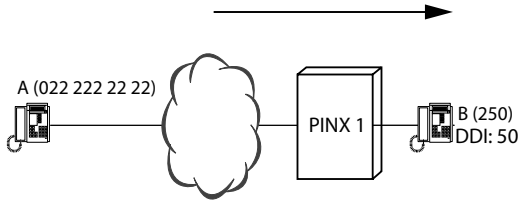

Fig. 165 User A calls user B (055 555 55 50)

Tab. 124 ICL output by PINX (destination PINX)

NO	CC	SC	DATE	TIME	DURATION	CHARGES	METPUL	EXCH
50250		321	180598	14:56	00H01m12	1.50	00015	00101

ID1	ID2	DEST1	DEST2	TTA	SEQ.NO.	SERIAL NO.
022222220	022222222		50	0023	014	1236

- NO PISN number of user B.
- SC External call, answered directly.
- ID1 User A wants to use this CLIP to present himself. It appears on user B's system phone display.
- ID2 Caller's CLIP number verified by the public network. Displayed to the destination user only if no ID1 CLIP is available
- DEST 1 Nothing is entered here with ICL output.
- DEST 2 50 is user's B direct dial number.

Incoming connection via a gateway PINX

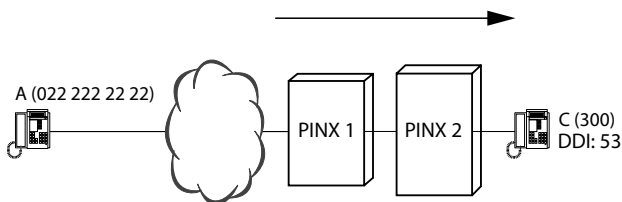

Fig. 166 User A calls user C (055 555 55 53)

Tab. 125 ICL output (line 1) and OCL output (line 2) at PINX 1 (gateway-PINX)

NO	CC	SC	DATE	TIME	DURATION	CHARGES	METPUL	EXCH
		343	180598	14:56	00H01m12			00103
		140	180598	14:56	00H01m12	0.00	00000	00119

ID1	ID2	DEST1	DEST2	TTA	SEQ.NO.	SERIAL NO.
0222220000	0222222222		53	0012	015	1237
0222220000	0222220000	50300	53			1238

- NO Nothing is entered here with Gateway PINX.
- SC 343: External incoming and answered transit call.
140: Outgoing transit connection to the PISN.
- ID1 User A wants to use this CLIP to present himself. It appears on user C's system phone display.
- ID2 Caller's CLIP verified by the public network. Displayed to the destination user only if no ID1 CLIP is available.
- DEST1 Nothing is entered here with ICL output.
- DEST2 53 is user C's direct dial number.

Tab. 126 ICL output at PINX 2

NO	CC	SC	DATE	TIME	DURATION	CHARGES	METPUL	EXCH
50300		421	180598	14:56	00H01m12			00102

ID1	ID2	DEST1	DEST2	TTA	SEQ.NO.	SERIAL NO.
0222220000	0222222222		50300	0012	007	5678

NO	PISN number of user C.
SC	Incoming call from the PISN, answered directly.
ID1	User A wants to use this CLIP to present himself. It appears on user C's system phone display.
ID2	Caller's CLIP verified by the public network. Displayed to the destination user only if no ID1 CLIP is available.
DEST1	This field is always empty for ICL output.
DEST2	PISN number of user C.

8.7.5 Protocol format

This format is used for direct output on the printer. It is used if data acquisition is not carried out on the data carrier of a corresponding system. The structure with page header and subsequent data lines is designed to make the protocol printout easier to read.

Page header

(does not contain any user data)

Tab. 127 Page header for protocol format

Content, text	Structure	Length	Print offset
Form Feed	FF, 0CH	1	0
Carriage Return	CR, 0DH	1	0
Line Feed	LF, 0AH	1	0
Space (2)	SP	2	0
NO (CC)	'NO' ('CC')	2	2
Space (4)	SP	4	4
SC	'SC	'2	8
Space (1)	SP	1	10
DATE	'DATE	'5	11
Space (2)	SP	2	16
TIME	'TIME	'4	18
Space (2)	SP	2	22
DURATION	'DURATION	'5	24
Space (4)	SP	4	29
EXCH	'EXCH	'3	33
Space (5)	SP	5	36
CHARGES	'CHARGES	'7	41
Space (2)	SP	2	48

Content, text	Structure	Length	Print offset
DIALLED	'DIALLED	'9	50
Space (1)	SP	1	59
NUMBER	'NUMBER	'6	60
Space (2)	SP	2	66
SERIAL NO.	'SERIAL NO.	'7	68
Line 1 end	CR	1	75
New line	LF	1	76
Space (2)	SP	2	0
'Underline	"_.._	'74	2
Line 2 end	CR	1	75
New line	LF	1	76

The page header

- can be suppressed with the setting `..._OCL page length = 99`.
- Output every time at the beginning of each page.
- Contains only formatting, no user data.

User data appears on the next line.

Example:

(see "Example of Protocol format", page 311)

Data lines

Tab. 128 Data lines for protocol format

Content, meaning	Structure	Format		Length	Print offset
Space	SP			2	0
User (cost centre) number ¹⁾	tttt	-	SP	5	2
Sort character	ooo	00	-	3	8
Date of start of connection	ddmmyy	00	-	6	12
Time of start of connection	hh:mm	00	-	5	19
Duration of connection	hhHmmMss	00	-	8	25
Trunk card number / network interface number / primary channel group ²⁾	bb.pp/c	00	-	5	34
Charges	ggggggg.gg	SP	-	10	40
Call number dialled ³⁾	zzzzzzzzzzzzzzzzzzzz	-	SP	20	51

Content, meaning	Structure	Format	Length	Print offset
Serial number	IIII	00 -	4	72
Carriage Return	CR		1	76
Line Feed	LF		1	77

- 1) Dialling determines whether user No. or CC No. is displayed. With exchange access 0 or 10, the user No. is displayed; if exchange access is used with CC No. 13 or if there is a switch to the cost centre during the call using *78, the CC No. is displayed. User numbers are always output with format "|- SPⁿ"; cost centre numbers, always with format "00 -|".
As a cost centre number this field can be 5 or 9 digits long. Depending on the configured cost centre length ≤ 5 the field is 5 characters long. As of cost centre length ≥ 6 the length is 9 characters. With cost centre length ≥ 6 , all the offsets following the cost centre are incremented by 4 characters.
- 2) The trunk card number is output in position "bb"; the network interface number in "pp"; and the primary channel group "c" in "c" (see example on [page 311](#)).
- 3) With *Data protection = On* the last 4 digits of the number are replaced by "" (full stop) characters. In Switzerland and other countries this applies to private calls (data protection for business calls never active); in Germany, business calls (data protection for private calls never active).

Example of Protocol format

(combined with header line):

NO	SC	DATE	TIME	DURATION	EXCH	CHARGES	DIALLED NUMBERS	SERIAL NO.
21	098	040597	07:23	00H00M20	03.02	1.20	0121....	0089
21	098	040597	07:24	00H00M34	03.02	3.40	0123....	0090
22	010	040597	07:25	00H00M15	03.02	0.30	165	0091
17	010	040597	07:26	00H00M11	03.01	0.30	164	0092

Incl. surcharge

With data protection

Numbers of up to 4 digits are printed in full

Fig. 167 CL output in protocol format

8.7.6 Individual receipt format

This format is used for output on the receipt printer for the purpose of confirmation and cash collection of the call made immediately beforehand.

As this structure is unlikely to be covered by an electronic system, no detailed description of the format will be given here.

Remarks

Example of individual receipt format:

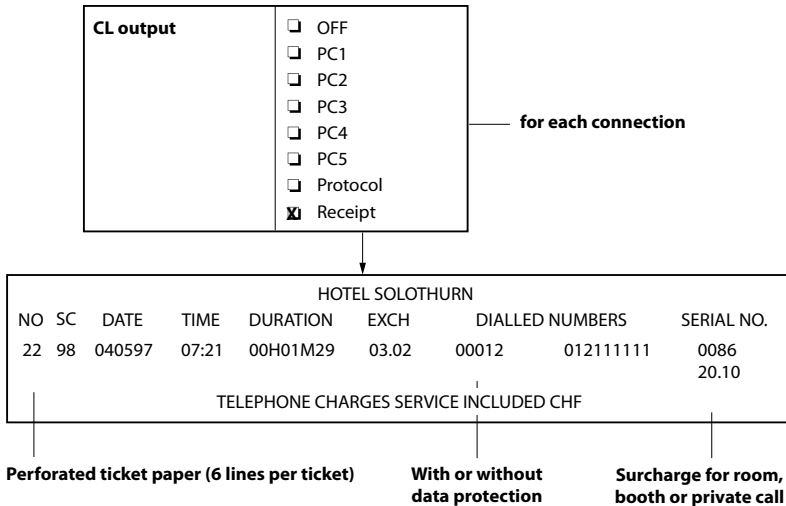

Fig. 168 CL output in Individual receipt format

If *Data protection* is configured, the field *Call number dialled* will contain the " " (space) character in the last 4 places.

The printout of the individual receipt ends with the character *ETX* (End of Text, 03 hexadecimal). This character is required by certain types of receipt printers to actuate the cutting device.

8. 7. 7 Output formats PC1 to PC4

Output formats PC1 to PC4 are older formats which, although they are still supported, are no longer being expanded. Output format PC 5 is therefore recommended for new applications.

At the end of each call the call data logged is printed out on one of the system's Ethernet interfaces in the *CL output* output type.

Data record field structure

The fields are separated by one or more "space" ASCII characters. The data import mask must therefore take account of the position of the beginning of the field ("Offset" column in the structural descriptions below).

The symbols and conventions listed in [Tab. 129](#) are used to format the fields:

Tab. 129 Format conventions

Symbol	Meaning
–	Right justified
–	Left justified
00	00 Padded with "0" up to the defined data field length
SP	Padded with spaces

Certain fields take on different formats depending on the system configuration. These exceptions are appended as notes directly after the structural descriptions.

Format field in the structural descriptions below:

Certain fields take on different formats depending on the system configuration.

|– SP: means left justified and padded with spaces.

Sort character

Special characters used in the data string

In principle, all outputs are in the form of text based on the ASCII standard. Special, non-printing ASCII characters are used for structuring the data records:

Tab. 130 Special characters

ID	Meaning	Hexadecimal value	Usage
HT	Horizontal tab	09	Start of a data record
SP	Space	20	Field separator
CR	Carriage Return	0D	End of a data record
LF	Line Feed	0A	End of a data record

Sort characters for the *CL printer* output type

Sort characters (SC) denote the type of connection and are shown in the *CL printer* output type.

NO	SC	DATE	TIME	DURATION	EXCH	CHARGES	DIALLED NUMBERS	SERIAL NO.
691	10	311290	05:20	01H03M45	10.02	67.70	005688223211	0678
21	90	311290	07:18	00H01M20	03.01	0.80	065248755	0679
23	16	311290	07:22	00H19M50	04.03	11.90	065243024	0680

Sort character

Fig. 169 Printout with sort characters

Tab. 131 The first digit of the sort character

Value	Meaning
0	Outgoing business exchange traffic, transferred
1	Outgoing business exchange traffic, self dialling
2	Incoming traffic
6	Outgoing cost centre exchange traffic, transferred
7	Outgoing cost centre exchange traffic, self dialling
8	Outgoing private traffic, transferred
9	Outgoing private traffic, self dialling

Tab. 132 The second digit means

Value	Meaning
0	Direct connection. Appears whenever "7" or "8" does not apply unambiguously.
1	Answered directly (incoming traffic)
2	Unanswered (incoming traffic)
4	Exchange-to-exchange connection, established by CFU / CFNR / CD to the network
5	Exchange-to-exchange connection, transferred by internal user
6	Outgoing data service connections
7	Outgoing connections on phone booth extensions
8	Outgoing connections on room extensions

Tab. 133 Examples

Value	Meaning
00	Outgoing business exchange traffic, transferred
10	Outgoing business exchange traffic, self dialling (normal case for business traffic)
14	Outgoing business exchange traffic, self dialling, established by CFU / CFNR / CD to the exchange
16	Outgoing data service connection, self dialling
80	Outgoing private exchange traffic, transferred
87	Outgoing private exchange traffic, transferred (phone booth extensions)
88	Outgoing private exchange traffic, transferred (room extensions)
90	Outgoing private exchange traffic, self dialling (normal case for private traffic)
97	Outgoing private exchange traffic, self dialling (phone booth extensions)
98	Outgoing private exchange traffic, self dialling (room extensions)

Maximal number length

If the internal numbers are longer than is possible in the output format, they will be truncated from the left.

If the external numbers are longer than is possible in the output format, they will be truncated from the right.

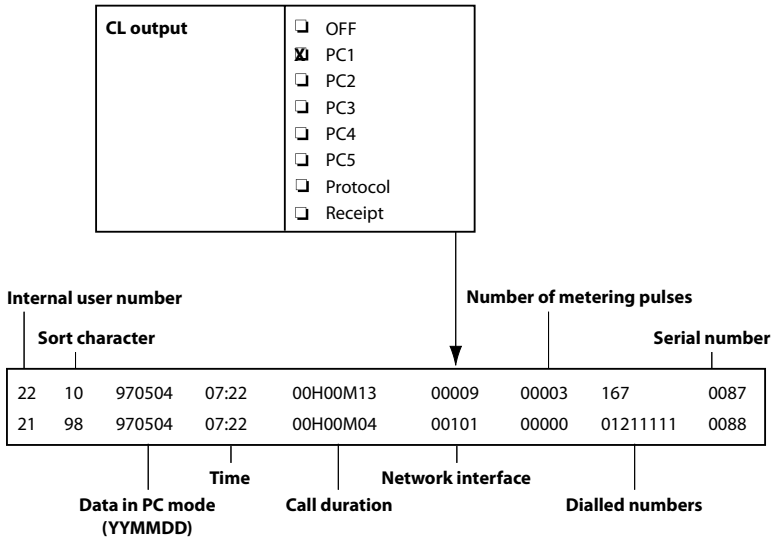

Fig. 170 CL output with PC1

8. 7. 7. 2 PC2 format

This format is an extension of the PC1 format. Here the cost centre number is also output as a separate field, along with the DDI number.

Format structure

Tab. 135 PC2 format

Data field, meaning	Structure	Format	Length	Offset
Start of data record	HT		1	0
User number	ttttt	- SP	5	1
Cost centre number	kkkkkkkk	- SP	9	7
Sort character	oo	00 -	2	17
Date of start of connection	yymmdd	00 -	6	20
Time of start of connection	hh:mm	00 -	5	27
Duration of connection	hhHmMss	00 -	8	33
Primary channel group / trunk card number / network interface number ¹⁾	cbbpp	00 -	5	42
Direct dialling numbers ²⁾	ddddddddd	- SP	11	48
Number of metering pulses	iiii	00 -	5	60

Example of PC4 format

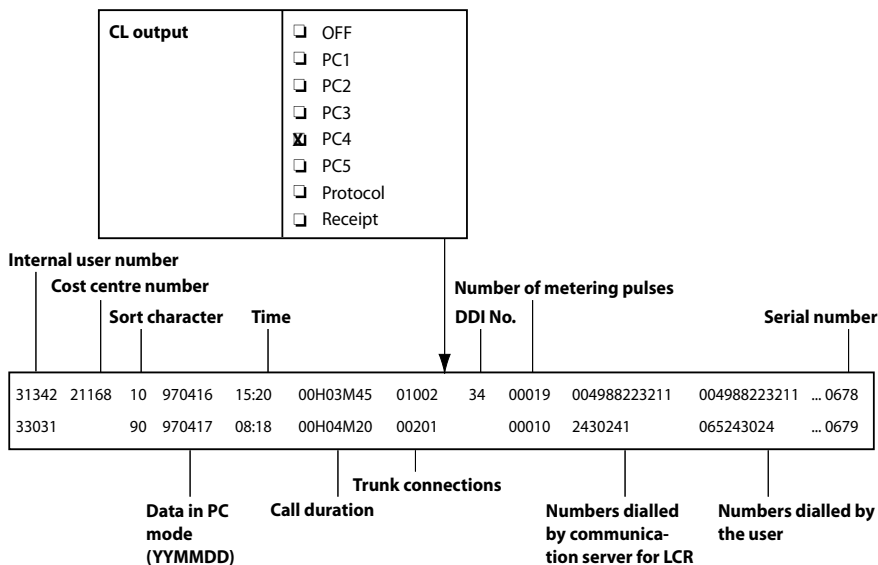

Fig. 172 CL output with PC4

Depending on the number dialled by the user and the configuration in the LCR tables the number actually dialled by the communication server may be different or identical.

9 Features

Aastra 400 provides a multitude of features that can be activated or operated by the user. This Chapter contains a systematic description of all these features.

9.1 Overview

The features described in this chapter are as follows:

- Call Forwarding Unconditional functions: Call Forwarding Unconditional, Follow me, Call Forwarding on No Reply, Twin Mode / Twin Comfort, Take, Do not disturb, Substitution.
- Connections involving several users: Enquiry call, Brokering, Three-party conference, Conference, Call transfer, Recall, Call acceptance
- Added features: Features that simplify day-to-day phone communication, e.g. Call waiting, Leave message, Park call, Team functions.
- Special features: Features that require a special application or hardware, such as voice mail.

The remote control of features, the hotel function and the alarming facilities using external text messages are described at the end of the chapter.

Tab. 137 The following features / functions do not form part of this chapter:

Feature / function	Description / document
Routing functions	Chapter "Routing elements", page 102 and chapter "Call routing", page 163
Identification and presentation functions	Chapter "Identification elements", page 67
Data-service functions	Chapter "Data service", page 255
Call logging	Chapter "Call logging (CL)", page 263
Device-specific functions of the system phones	Operating Instructions



Tip:

Certain features depend on the software version of the communication server. For system terminals with a display this may look like the following:

1. Access the configuration menu
2. Long-click on the * key

Depending on the system phone, additional information is displayed.







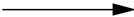

9.1.1 Description categories and terminology

Each feature consists of a detailed description with the following headings:

- Scenario
- Detailed Description
- Prefix and suffix dialling Function Codes
- System configuration
- Reference to Other Features

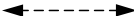
An illustration represents the feature scenario in a simple, clearly structured form. The following symbols are used:

Tab. 138 Symbols used

Call set-up	
Cancel call set-up	
Connection active	
Active connection cleared down	
Connection on hold	
Connection on hold cleared down	
Conference circuit	
Activating a feature	

Detailed Description

This heading contains:

- A description of the feature-relevant signalling on the system phones.
- A definition of the scope within which the feature can be carried out.
- Remarks, tips or information on the sequence of operation of the feature or on exceptional cases.

Prefix and suffix dialling Function Codes

*/# function codes are used to control features. A function can be triggered under three different sets of conditions:

- In prefix dialling: dialling takes place before any connection is made.
- In suffix dialling: dialling takes place during a connection or call.
- During the ringing phase: dialling takes place during the ringing phase of an incoming call

Depending on the nature of the feature a function is triggered either in prefix dialling, in suffix dialling, during the ringing phase or in several call states.

On system phones, user-related features are activated or deactivated using the Foxkey, under which a variety of functions can be stored. Equipment-specific settings can be found in the relevant user's guide for the system phones concerned.

System configuration

Designation of the parameters concerned in the system configuration and their settings.

Reference to Other Features

List of associated or linked features.

9.1.2 Information about the system phones

Unless otherwise specified, information on the system phones Office 45 also includes Office 45pro, Aastra 5360 also includes Aastra 5360ip, Aastra 5361 also includes Aastra 5361ip, Aastra 5370 also includes Aastra 5370ip, Aastra 5380 also includes Aastra 5380ip, Office 135 also includes Office 135pro, Aastra 1560 also includes Aastra 1560ip and Office 1560 also includes Office 1560IP. Finally, Office 160 stands for Office 160pro, Office 160ATEX and for Office 160Safeguard.

9.1.3 Terminology

The following terms are used:

Tab. 139 Terms are used

Term	Usage
Internal user	An internal user has an internal user number. An internal user is assigned one or more terminals.
External user	An external user is located in the public network (outside the private network).
PISN users	A PISN user is connected to another node (PINX) of the private network (PISN: Private Integrated Services Network). A PISN user can also be a user in a virtual PINX (virtual PISN user).
User A	1. User in a feature scenario (the person who sets up a call for example)
User B	2. User in a feature scenario (the person who answers user A's call for example).
User C	3. User in a feature scenario (enquiry call between user B and user C for example)
Service	Function offered by the network provider and carried out in the public network, in particular an ISDN supplementary service.
Feature	Function provided by the system and carried out locally in the communication server.

9.2 Network services, authorizations and operation

9.2.1 ISDN services supported by the system

The system supports a whole series of ISDN supplementary services, which are provided by network providers in addition to ISDN bearer services.

9.2.1.1 External services and internal features

In this document a distinction is made between features and services.

Features designate functions that are provided locally in the communication server.

Services designate functions that are offered at the network interfaces by the public ISDN network provider and supported, i.e. used, by the communication server.

ISDN services are further differentiated into bearer services and supplementary services.

A certain number of functions such as the three-party conference with two external users can be carried out both externally in the public network and internally in the communication server.

The example of a three-party conference is used to illustrate the interaction between the communication server and the public network.

Example of a three-party conference

The figures below show variants of three-party conferences with internal and external users.

The left-hand side of the figure below shows a conference set up in the communication server with three internal users (three-party conference feature); the right-hand side shows a conference in the public network with three exchange users (three-party conference supplementary service):

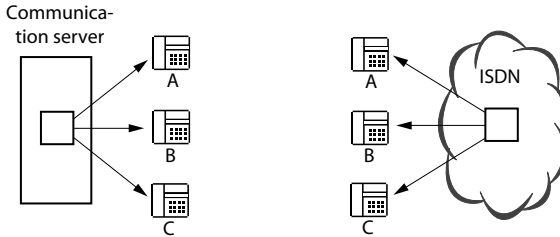

Fig. 173 Conference circuit feature and three-party conference supplementary service

The figure below shows a three-party conference connected in the communication server with one internal user and two exchange users:

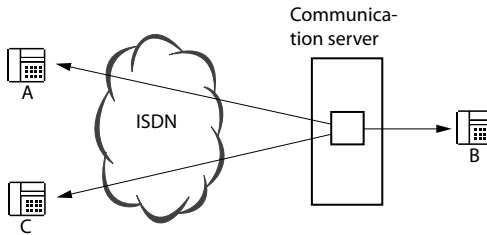

Fig. 174 Three-party conference feature with 1 internal and 2 external users

The three-party conference feature is carried out locally in the communication server. Two B channels are seized as a result.

If the system requirements are met, the three-party conference with one internal and two external users can also be transferred to the exchange.

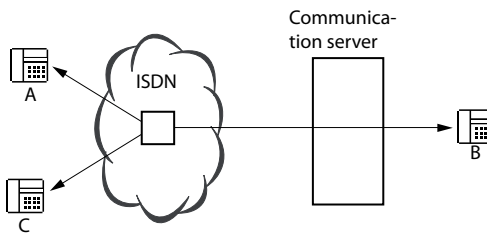

Fig. 175 Three-party conference as a service in the public network, with 1 internal and 2 external users

The supplementary service three-party conference is activated locally but moved from the system to the public network. Only 1 B channel is seized as a result.

9.2.1.2 ISDN supplementary services supported

In the following overview ISDN supplementary services are categorized as follows:

- Identification services
- Connection services
- Rerouting services
- Call charge services
- Other services

As a rule network interfaces are wired as a point-to-point connection (P-P). However, the point-to-multipoint (P-MP) connection type is also possible. Not all ISDN supplementary services are provided by network providers on both connection types or supported by the communication server.

Identification services

Tab. 140 Identification services

Name of the service		Remark	P-P	P-MP
CLIP	Calling Line Identification Presentation	Displays the caller's number to the called party	✓	✓
CLIR	Calling Line Identification Restriction	Suppresses the display of the caller's number to the called party	✓	✓
COLP	Connected Line Identification Presentation	Displays the called party's number to the caller	✓	✓
COLR	Connected Line Identification Restriction	Suppresses the display of the called party's number to the caller	✓	✓
DDI	Direct Dialling In	Direct dialling	✓	–
MCID	Malicious Call Identification	Records malicious calls	✓	✓
MSN	Multiple Subscriber Number	Multiple subscriber number	–	✓

Connection services

Tab. 141 Connection services

Name of the service		Remark	P-P	P-MP
HOLD	Call Hold	Holds a connection in the exchange. Precondition for enquiry calls, brokering and three-party conferences in the exchange	–	✓
ECT	Explicit Call Transfer	Call transfer in the exchange	–	✓
CCBS	Completion of Calls to Busy Subscriber	Callback if busy in the exchange	✓	✓
3PTY	Three-Party Conference	Three-party conference in the exchange	–	✓

Rerouting services

Tab. 142 Rerouting services

Name of the service		Remark	P-P	P-MP
CFU	Call Forwarding Unconditional	CFU in the exchange, supported via */# function code	✓	✓
CFB	Call Forwarding Busy	CFB in the exchange, supported via */# function code	✓	✓
CFNR	Call Forwarding on No Reply	CFNR in the exchange, supported via */# function code	✓	✓
CD	Call Deflection	Supported as a user-related feature and used by the system to transfer CFU / CFNR / CD to the exchange.	–	✓
PARE	Partial Rerouting	Used by the system to transfer CFU / CFNR / CD to the exchange.	✓	–

Call charge services

Tab. 143 Call charge services

Name of the service		Remark	P-P	P-MP
AOC-D	Advice of Charge (During)	Call charge information during the call	✓	✓
AOC-E	Advice of Charge (End)	Call charge information at the end of the call	✓	✓

Other services

Tab. 144 Other services

Name of the service		Remark	P-P	P-MP
UUS-1	User-to-User Signalling	Signalling from one user to another user Supported only during setup and only for ISDN terminals on the BRI-S interface.	✓	✓
SUB	Subaddressing	Subaddressing	✓	✓
	Keypad Signalling	*/# function codes in the exchange	✓	✓

9. 2. 2 Notifications supported by the system

Notifications are used for transmitting information on a connection's current status and can be shown for example on the display of system phones. The notifications supported by the public ISDN network are also partly supported by the system, converted accordingly for private QSIG networks, or forwarded transparently to connected ISDN terminals.

Notifications sent to the public ISDN network by the communication server can be inhibited in the trunk group configuration using the parameter *Send notifications = No*.

The following table provides an overview of the notifications supported by the communication server or forwarded transparently:

Tab. 145 Notifications supported:

Notification	incoming on:		Outgoing	Meaning / Remarks
	System phone	ISDN terminal		
Remote hold	yes	transparent	yes	User on hold
Remote retrieval	yes	transparent	yes	Return to previous user or connect with new user
User suspended	yes	transparent	yes	User parked
User resumed	yes	transparent	yes	User retrieved
Conference established	yes	transparent	yes	Conference set up
Conference disconnected	yes	transparent	yes	Conference terminated
Call is diverting	yes ¹⁾	transparent	yes ¹⁾	Diverted call
Call is a waiting call	yes	transparent	yes	Call is a waiting call

¹⁾ Depending on the network provider, redirecting information is also transmitted with incoming calls, in addition to the notification. With outgoing calls the communication server also sends the redirection information instead of the notification (see also "Display for Call Forwarding Unconditional", page 81).



Note:

Notifications in networks are not supported via the BRI-S external interface with the protocol DSS1.

9.2.3 SIP-RFC supported by Aastra 400

RFC (Requests for Comments) are chronologically numbered, freely accessible documents in which the quasi-standards developed are published on the internet.

A whole range of RFCs are supported for connecting Aastra 400 communication servers to SIP providers on the one hand and SIP terminals to Aastra 400 communication servers on the other. They can be found in a table in the "SIP and SIP terminals" System Manual.

9. 2. 4 Features in the private network

This Chapter describes the user-related features in a PISN.

Standardized operation and signalling

The way in which a feature is actuated on the terminal and its signalling are identical whatever the network used (local, PISN or public network).

Scope of performance

The range of services in a PISN is determined by the following criteria:

- Local features of the system
- Type of networking (QSIG or virtual with DSS1)
- Offer available from the public network provider

9. 2. 4. 1 Networking with QSIG

The standardized QSIG protocol supports a wide range of basic and supplementary services. The system supports the following services:

- Display call numbers (CLIP) and names (CNIP)
- Enquiry/Hold/Brokering
- Call transfer with/without prior notice
- Conference (variable, preconfigured)
- Call Forwarding Unconditional (CFU) and Call Forwarding on No Reply (CFNR)
- Deflect/reject call during ringing phase
- Do not disturb
- Recall
- Callback if busy

Under QSIG the activated feature is indicated on system phones with a display, e. g. *Conference*.

9.2.4.2 Virtual Networking in the ISDN Network

In a virtual networking or in a virtual PINX in the public network the following conditions have to be met:

- The feature is supported end-to-end by the public ISDN network.
- Service compatibility between private ISDN and public ISDN is guaranteed for the feature.

Example: Callback if busy

"Callback if busy" is supported within the private network. Compatibility for this feature between private network (QSIG protocol) and public network (DSS1 protocol) is guaranteed. It is possible to activate callback between A and C and between B and C (Fig. 176) if the public network supports the feature end-to-end.

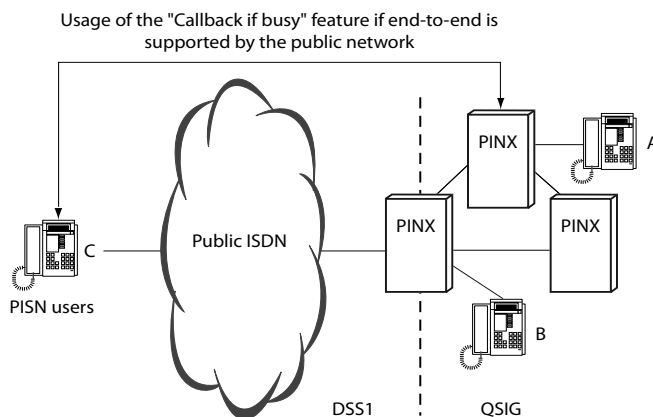

Fig. 176 Using a feature via the public network



Note:

With the overflow procedure (see "Testing overflow routing in the PISN", page 246) calls within the PISN are routed via the public network. In this case the conditions for networking with DSS1 apply. The ranges of services available can be restricted for such calls.

9.2.5 Features in the up-circuit communication server

A number of features can be triggered in the up-circuit communication server using route selection. For more details please refer to the user's guides of the terminals and the features overview of the up-circuit communication server.

9.2.6 Features operated via QSIG

In private QSIG networks a number of features can be operated on third-party PINXs via QSIG (applies only to Aastra 400 or Aastra IntelliGate systems). In such cases it is irrelevant whether the QSIG networking is effected via a basic rate access or a primary rate access and which QSIG variant is selected as the protocol. The executing user obtains (visual) confirmation as to whether or not the feature was successfully carried out.

9.2.6.1 User-unrelated features

User-unrelated features are operated via abbreviated dialling numbers defined on the destination PINX and containing the corresponding function codes. These abbreviated dialling numbers are entered on one's own PBX as PISN users in the numbering plan.



Note:

Make sure that these abbreviated dialling numbers are barred in the digit barring on all PINXs for unauthorized users and that no names are assigned to the abbreviated dialling numbers (bypassing the digit barring).

The following features are supported:

Tab. 146 User-unrelated QSIG features

Feature	Activate	Deactivate
Operate switch groups	*85<Switth group><Pos.>	
Actuate door opener	*74 <No. of the door intercom system>	
Switch control output	*74 <Call number ¹⁾ >	#74 <Call number ¹⁾ >
Enable/bar a one-off remote access	*754	#754
Answer coded ringing on general bell	*82	
Answer ring call on general bell	*83	
Dial door intercom	851,852 (default values) ²⁾	

¹⁾ call number assigned to this control output in the numbering plan

²⁾ Only with Aastra 415/430 and if the corresponding number of ODAB card(s) is fitted

9.2.6.2 User-related features

Operation of the user-related features is subject to the definition of the PISN users in one's own numbering plan. The features can be divided into two groups:

Features That Set up a Call Connection

The following user-related features are supported by the communication server and can be activated via the keypad, the function key or the Foxkey:

Tab. 147 QSIG features with call connection

Feature	Activate
Call pick-up	*86 PISN user number

Features That Can Be Activated/Deactivated

All remote-controlled user-related features listed in [Tab. 352](#) are supported by the communication server and can be activated or reset via the keypad or function key. The only requirement is that the PISN user concerned is not protected against remote control and that *06 is not barred in the internal digit barring for the user executing the feature.

Example: Clearing CFU for a PISN user: *06 <PISN user number> #21

System configuration

Due to the proprietary protocol, attempts at operating a user-related feature of an older or third-party PINX via QSIG can lead to incorrect interpretations. That is why the protocol extension can be inhibited in the trunk group configuration using the parameter *QSIG extension = No* (initialisation setting = *No*).

9.2.7 User-related authorizations

A class-of-service authorization in the user configuration is required in order to run user-related features.

In addition specific features and call destinations can be disabled using the internal digit barring (see "[Digit barring](#)", [page 191](#)).

9.2.8 Exchange access authorizations

Exchange access authorization

Exchange-to-exchange connections have to be authorized to enable the features conference, Call Forwarding Unconditional and call transfer between two external users (exchange-to-exchange connections can be further restricted, see "[Exchange-to-Exchange Connections](#)", page 223).

Authorization to transfer exchange-to-exchange functions to the exchange

For exchange-to-exchange three-party connections to be transferred to the exchange, the relevant authorizations have to be enabled in the trunk group configuration.

For exchange-to-exchange Call Forwarding Unconditional to be transferred to the exchange, the relevant authorizations have to be enabled in the trunk group and user configurations.

9.2.9 Operating the features on the terminal

9.2.9.1 Feature activation

With system phones, features can be operated in the following ways:

- Menu-supported with Foxkey for all system phones with a display and for the Aastra 1560 / Office 1560 PC operator console
- Using the Foxkey alone, for system phones without a display
- via function keys (see [Tab. 148](#))
- With suffix dialled digits, in a specific connection status (e.g. suffix dialling digit 2 switches back and forth between two connections) For this the DTMF mode must not be activated on the system phone.

With commercially available system terminals by other manufacturers, features can be operated in the following ways:

- ISDN terminals:
 - By menu for ISDN services supported by the system on the S bus as per ETSI (see [Tab. 375](#)).

- With */# function codes
- Analogue terminals: With */# function code or control key

Changing the standard mode for DTMF

A number of functions can be operated in suffix dialling (e.g. for voice mail system) by keying in DTMF dial signals. For this the terminal has to be switched to DTMF mode (Transparent Mode). This is done with a long-click of the *-key or with the Foxkey.

The system phones automatically switch over to DTMF mode as standard once a connection has been set up. This setting can be altered for each phone using the Foxkey or via AMS.

9.2.9.2 Configurable keys

The possibility of configuring keys with various functions means that system phones offer a practical way of operating features (for more information see user's guide of the phones).

Configuration of a configurable key by the end user can be disabled by the system administrator using AMS.

Tab. 148 Configurable keys of the system phones

Number key	Function key	Team key
Office 10, Office 25, Office 35, Office 45, Aastra 5360, Aastra 5361, Aastra 5370, Aastra 5380, Office 135, Office 160, Aastra 610d, Aastra 620d, Aastra 630d, Aastra 1560, Office 1560, Aastra 2380ip	Office 10, Office 25, Office 35, Office 45, Aastra 5360, Aastra 5361, Aastra 5370, Aastra 5380, Office 135, Office 160, Aastra 610d, Aastra 620d, Aastra 630d, Aastra 1560, Office 1560, Aastra 2380ip	Office 35, Office 45, Aastra 5361, Aastra 5370, Aastra 5380 with expansion keypad, Aastra 1560, Office 1560, Aastra 2380ip

Number key

One or two frequently used, external or internal call numbers can be stored under a number key. The call number in memory 1 is selected by clicking the key once; the call number in memory 2 by double clicking.



Note:

Double-clicking is not possible on the Foxkey, on the Hotkey (Office 135, Office 160) and on the number keys of an Aastra M535.

**Tip:**

The call number of a call distribution element can also be stored under a number key, provided it is listed in the internal numbering plan.

Function key

A frequently used function can be stored under a function key. The function is activated and deactivated simply by pressing the key. All system phones support keys with two storage slots: The activation and deactivation of the function are stored on the first and second storage space respectively. Pressing the key the first time activates the function and the corresponding LED or display; pressing the key a second time deactivates it.

Function keys can be set up using the terminal or AMS. Important functions are predefined and provided on the menu.

On system phones without a display the function keys can only be set up using AMS.

Team key

The team functions make it easier for members of a team (for example a sales or marketing team) to communicate with one another and stand in for one another where required. One team key is configured for each team member and allows the following functions and signalling states:

- Calling a team member using a simple keypress
- Signalling an incoming call for the team member and pick up the call using a simple keypress
- Signalling an existing connection to the team member (differentiating between internal and external call on Office 45, Aastra 5380 and Aastra 1560 / Office 1560).
- And, depending on the terminal, other telephony functions (e.g. setting up an announcement to the team member)

Foxkey

All the system phones have a Foxkey, i.e. a variable function key that intelligently adapts to provide the right functions for each situation so that all the terminals can be operated intuitively. In the idle state, the Foxkey can also be assigned numbers or functions (except Office 10); it can then be used as a number or function key.

9.2.10 Languages supported

The system supports a multitude of languages for the texts used on the user interface of system phones and AMS. The languages available vary depending on the user interfaces:

Tab. 149 Languages supported

Languages ¹⁾		System phone	Aastra 1560/ Office 1560	Communication server	AMS
Danish	da	✓	✓	✓	-
German	de	✓	✓	✓	✓
English	en	✓	✓	✓	✓
Estonian	et	✓	-	-	-
Finnish	fi	✓	✓	✓	-
French	fr	✓	✓	✓	✓
Greek	el	✓	✓	-	-
Dutch	nl	✓	✓	✓	✓
Italian	it	✓	✓	✓	✓
Norwegian	no	✓	✓	✓	†
Polish	pl	✓	-	-	-
Portuguese	pt	✓	✓	✓	✓
Swedish	sv	✓	✓	✓	-
Spanish:					
• Standard Spanish (castilliano)	es	✓	✓	✓	✓
• Basque (euskera)	eu	✓	-	-	-
• Galician (gallego)	gl	✓	-	-	-
• Catalan	ca	✓	-	-	-
Czech	cs	✓	-	✓	3
Hungarian	hu	✓	-	-	-
Welsh	cy	✓	-	-	-

¹⁾ Other languages may be added

System phones

Operating languages on the system phones:

- All the languages listed are available.
- Can be set via menu and AMS.

- Cordless phones in the "Out of Range" state have thirteen languages stored locally (Standard Spanish (castilliano) is displayed instead of regional Spanish languages; English is displayed instead of Polish, Czech and Hungarian).
- The System Assistant on Office 45 automatically takes over the language set in the system phone.
- Standard text and event messages are available in the specified languages with the exception of Greek. A country-specific language as well as de, fr, and en are provided. The default language is specified for each country after initialization.

Aastra 1560 / Office 1560 operator console

Operating languages on the operator console:

- All the languages listed are available
- Can be set via the menu

Communication server

Operating, display and output language of communication server-generated texts:

- Operating languages for system settings via Office 45: Choice of language depends on the operating language selected on the system phone.
- Display language for event messages. Can be set in the Fault & Maintenance Manager
- Output language for call logging can be set on the Account Manager.
- Office 45: Can be set via the menu and AMS

Default values

- The default currency value is defined by country based on international abbreviations. It can be configured in all specified languages at a later time with AMS.
- The title for an OCL / ICL printout is defined per country based default value on international abbreviations. It can be configured in all specified languages at a later time with AMS. This also applies to the language of the OCL / ICL printouts (excluding Greek).

AMS

Operating languages for AMS:

- All the languages listed are available.
- Can be set via the menu. Restart the application after selecting a language.

9.3 One Number user concept

The One Number user concept is used to assigned several terminals to one user. The user has only one name and one call number with which to identify himself to his call partners, regardless of which of the terminals assigned to him he happens to be using to make his calls. The advantage is that a user can always be reached under the same call number, regardless of where he happens to be. An internal or external call to the user is routed to all or only some of the terminals assigned to him (configurable).

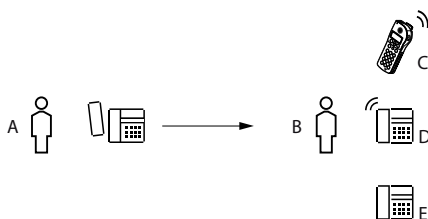

Fig. 177 One Number

Other properties:

- The user can use the *Personal call routing* function (*45) to specify which terminals calls should be to. 5 additional call routings besides the default setting (call all terminals) can be defined in AMS. For such a profile to be valid, at least one terminal has to be entered in the call routing. Only one call routing per user can be active at any one time.
- The *Ring Alone* function (*41) makes it possible for incoming calls to be acoustically signalled on only one of the allocated system phones. The call is signalled visually on all system phones and can also be answered on all the terminals. The function is carried out on the only terminal to call.

**Note:**

The function can be executed from any terminal. However the purely visual signalling is supported only by the system phones of the Aastra 5300 and Aastra 5300ip series and by the Aastra 2380ip soft-phone.

- The *Busy if busy* parameter is used to configure whether or not a user should be busy for other callers. If the parameter is set to *No*, the other terminals ring in the normal way and the call can be answered on one of these terminals.
- If a user terminal is busy, calls can still be made with the user's other terminals.
- A user with several terminals can even call himself by dialling his own user number. The call is signalled on all his free terminals.
- Call lists and contacts are available on all system phones and are automatically synchronised.
- If a user is not assigned a terminal, he cannot be reached by other users. The destinations configured for when the user is unobtainable are applied.
- If the terminal is not assigned to any user, it cannot be used. *Not configured* is then indicated on system phones with a display.
- An announcement made to a user is signalled on all of his terminals which support announcements.
- Fast Take (*88) can be used to answer a call from one terminal to another terminal belonging to that same user. No special authorizations are required.

Restrictions:

- Only 16 terminals are allowed per user.
- Only one each of the following terminals can be allocated to a user:
 - Cordless phone
 - IP system phone as a softphone
 - Operator console

Functions in prefix dialling

Tab. 150 Functions

Functions	Function codes	Remarks
Activate personal call routing	*45 <Call routing 0...5>	The default setting is 0 (call all terminals).

Functions	Function codes	Remarks
Deactivate personal call routing	#45	#45
Activate Ring Alone	*41	
Deactivate Ring Alone	#41	

System configuration

Tab. 151 Personal call routing: System configuration

Parameter	Parameter value	Remarks
<i>Call routing 1...5</i>	<Ring / ->	<i>Allocated terminals</i> tab in the user configuration. The default setting 0 (all terminals on <i>Ring</i>) cannot be altered.
<i>Description</i>	<Name>	<i>Allocated terminals</i> tab in the user configuration.
<i>State</i>	<Activated / Deactivated>	Status display on the <i>Personal call routing</i> tab in the user configuration.

9.4 Call Forwarding Unconditional functions

9.4.1 Call Forwarding Unconditional (CFU)

Calls intended for B are diverted to destination C.

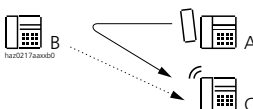

Fig. 178 Call Forwarding Unconditional

Call Forwarding Unconditional responds differently depending on the System Configuration and the function code used. The various CFU types are as follows:

- CFU to a variable destination:
The user specifies the chosen call forwarding destination on his terminal. This CFU can be either unconditional or only if busy.
- Preconfigured CFU:
The call forwarding is made unconditionally to a destination entered in the user configuration. This destination is also used with the Leave message feature if the caller is unable to read messages on his terminal.
- CFU if unobtainable:
The user configuration can specify where a call should be routed if a terminal is unobtainable. Different destinations can be configured depending on the rea-

son for the unavailability and the call's origin (see "Response if unobtainable", page 184)



Note:

An existing call forwarding is overwritten by a new call forwarding. CFU Unconditional, CFB and Call Forwarding on No Reply (see page 346) are equivalent.

Detailed Description

Tab. 152 Call Forwarding Unconditional

Interface	Operating sequence / signalling on the terminal	Scope
B	<ul style="list-style-type: none"> Obtains acknowledgement tone when activating and resetting the CFU If <i>CFU first ring = yes</i> is configured and C is an internal user, B obtains an attention tone (short ring) and has 5 seconds in which to answer the call. 	Restriction: B can only activate a single Call Forwarding Unconditional. Each new one overwrites the old one.
C		Possible destinations: <ul style="list-style-type: none"> Users: internal, external¹⁾, PISN²⁾ Coded ringing UG: 17 to 21 (System 2065: 25 to 29) and user groups configured as "large". Standard text (leave message) Requirement: C is not protected against Call Forwarding Unconditional (*02).

¹⁾ see "Call Forwarding Unconditional to exchange", page 342.

²⁾ The conditions for Call Forwarding Unconditional to exchange apply to PISN users in the public network or on a virtually connected PINX.



Note:

The internal number of a call distribution element can only be used as the destination for a CFU in a special case, namely if at least one CDE destination is configured on ACD. If not, *Not available* is displayed whenever the function is activated. Any configured CDE destinations that are not ACD are never executed.

Call forwarding chains:

- Internal: CFU chains can be set up locally (maximum 20);
- In the PISN: CFU chains are permitted. They are however restricted by the transit counter.

**Note:**

The function code *67 (CFB) and *61 (Call Forwarding on No Reply) interrupts a chain of call forwarding (*67 or *61 is no longer carried out).

Call forwarding loops:

- Internal: not permitted.
- In the PISN: restricted by the transit counter.

C is the only user who can still reach B.

Functions in prefix dialling

Tab. 153 Call Forwarding Unconditional: Functions

	Function codes
Activate CFU / CFB to any user No.	*21 destination No. / *67 destination No.
Activate CFU / CFB to user last configured	*21# / *67#
Clear CFU / CFB	#21 / #67
Activate preconfigured CFU	*22
Clear preconfigured CFU	#22
Activate CFU to standard text	*24 text No. [param.] #
Clear CFU to standard text	#24
Activate CFU to general bell (coded ringing)	*28
Clear CFU to general bell (coded ringing)	#28
Protect (own set) against CFU	*02
Allow CFU (to own set)	#02

System configuration

Tab. 154 Call Forwarding Unconditional: System configuration

Parameter	Parameter value	Remarks
<i>Preconfigured CFU</i>	<Dest. No.>	User configuration
<i>CFU first ring</i>	Yes / No	User configuration
<i>CFU/CFNR destination</i>	<Dest. No.>	User configuration: Shows the activate destination. The destination number cannot be altered.
<i>CFU/CFNR type</i>	<Call forwarding type>	User configuration: Shows the active call forwarding type. The call forwarding type cannot be altered.
<i>Rerouting in the Exchange</i>	Yes / No	User configuration

Parameter	Parameter value	Remarks
<i>Rerouting in the Exchange</i>	Yes / No	Trunk group configuration
<i>Wait for connection</i>	Yes / No	see "Call Forwarding Unconditional to exchange", page 342
<i>Last mailbox for CFU/CD</i>	Yes / No	see "Response to call forwarding chains", page 391

Reference to Other Features

Features:

- "Leave message", page 420
- "Follow me", page 345
- "Call Forwarding on No Reply (CFNR)", page 346
- "User group: Logging in and logging out", page 472
- "Deflecting a call during the ringing phase (CD)", page 349

9.4.1.1 Call Forwarding Unconditional to exchange

Settings for exchange-to-exchange traffic (see also "Exchange access authorizations", page 332)

- Exchange-to-exchange connection enabled:
 - External and internal calls are diverted to an external destination; a first-ring CFU is not carried out. Requirement: User with direct dial is defined.
 - If the conditions for transferring the Call Forwarding Unconditional to the exchange are also met, the connection is transferred to the network (see "Transferring Call Forwarding Unconditional to the Exchange", page 231).



Note:

Exchange-to-exchange connections can be further restricted, see "Exchange-to-Exchange Connection", page 223.

- Exchange-to-exchange connection not enabled:
 - External calls are not diverted to an external destination.
 - Internal calls are diverted to an external destination.

Calls that reach the user via user group are diverted externally only if the parameters on the user group and user allow it ("Call Forwarding Unconditional (CFU) for user group members", page 138).

9.4.1.2 Wait for connection setting

Specifies whether a Call Forwarding Unconditional of an external call to the exchange is always switched through or only if the called party answers a call (and a connection is therefore set up):

- *Wait for connection = No*
The Call Forwarding Unconditional is always switched through.
- *Wait for connection = Yes*
The Call Forwarding Unconditional is switched through only if a connection is set up.
If the destination user is busy or unobtainable, this setting ensures that the caller does not incur charges for the connection up to the communication server.

Example

CFU to the number of a mobile phone user who has switched his phone off:

- If *Wait for connection = No* has been set, the Call Forwarding Unconditional will be switched through: The callers will obtain a spoken text provided by the mobile service provider, indicating that the required user cannot be reached at present.
- If *Wait for connection = Yes* is set, the Call Forwarding Unconditional is not switched through and the caller will obtain the ring-back tone.

Scope

This feature is available only with stand-alone communication servers and gateway PINXs.

9.4.1.3 Examples of Call Forwarding Unconditional

The following examples illustrate three different cases of call distribution:

- Digital network interface without DDI or DDI number to user.
- Digital network interface with DDI number to user + UG busy.
- Digital network interface with DDI number to user + KT and user + KT busy.

Digital network interface without DDI or DDI number to user

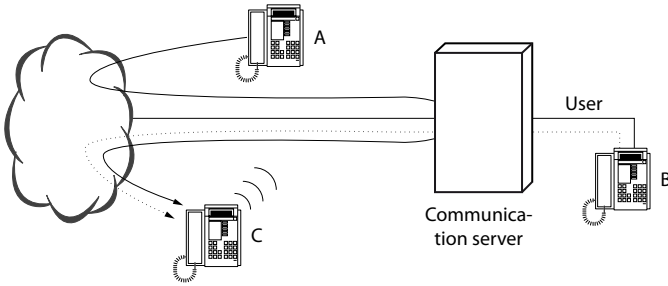

Fig. 179 Digital network interface without DDI or DDI number to user

- B makes a CFU to C.
- A calls B, communication server sets up direct connection with C, C rings.
- If user C is busy, A obtains the busy tone.

Digital network interface with DDI number to user + UG busy

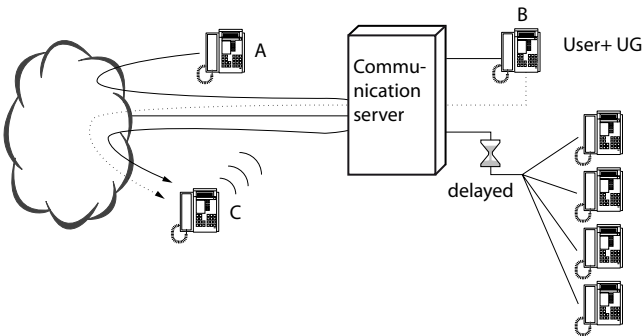

Fig. 180 DDI number to user + UG busy

- UG is delayed.
- B makes a CFU to C.
- A calls B, communication server sets up direct connection with C, C rings.
- The user group will become active irrespective of the configuration of the *Wait for connection* parameter.
- If user B is busy, A obtains the busy tone.

Digital network interface with DDI number to user + KT and user + KT busy

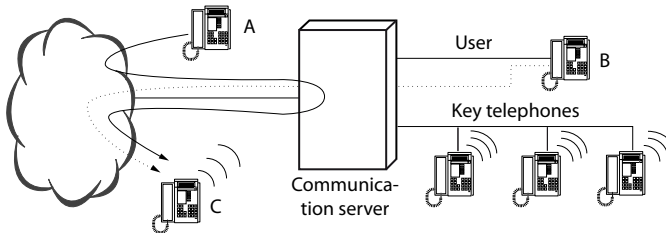

Fig. 181 DDI number to user + KT and user + KT busy

- B makes a CFU to C.
- A calls B, communication server sets up direct connection with C, C rings.
- The KT terminals with the line key also ring.
- If KT line is busy and C is busy, A obtains the busy tone.
- If C is busy, the KT line will ring. A obtains ring-back tone.

9.4.2 Follow me

User B wants to divert calls originally made to his own terminal to a terminal C, where he is currently located. He therefore configures a Call Forwarding Unconditional directly on destination terminal C.

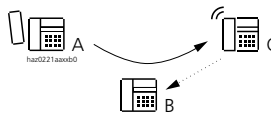

Fig. 182 Follow me

Detailed Description

Tab. 155 Follow me

Interface	Operating sequence / signalling on the terminal	Scope
C	Once the feature has been activated, the user obtains an acknowledgement tone.	Possible interfaces: Internal

The call forwarding from B to C remains active until user B cancels Follow me on his own terminal.

The functions configured on the user's own terminal (e.g. exchange access) are not transferred to the destination terminal.

A call forwarding already activated will be overwritten by Follow me.

Follow me will interrupt any Call Forwarding Unconditional chains.

Functions in prefix dialling

Tab. 156 Follow me: Functions

Functions	Function codes
Activate Follow me on the destination phone	*23 user No. B
Clear Follow me on the user's own phone	#23

System configuration

Tab. 157 Follow me: System configuration

Parameter	Parameter value	Remarks
No settings		

Reference to Other Features

Features:

- "Call Forwarding Unconditional (CFU)", page 339

9. 4. 3 Call Forwarding on No Reply (CFNR)

Unlike Call Forwarding Unconditional, the call to user B's terminal is initially signalled in the normal way when CFNR is activated. If the called party B does not answer the call after (0), 3, 5 or 7 ringing cycles, the call will also be signalled (in parallel) on the terminal of user C, who has been forwarded.

If the call was forwarded to C and was not answered by B, the next call will immediately be signalled to both users B + C. The delay in the call to C is reactivated only once the call has been answered directly by called party B. For the delay always to be active, the parameter *CFNR immediate ring* valid throughout the system must be configured to *No*.



Fig. 183 Call Forwarding on No Reply

Call Forwarding on No Reply responds differently depending on the system configuration and the function code used.

- Normal CFNR:
The user specifies the chosen call forwarding destination on his terminal.
- Preconfigured CFNR:
The call forwarding is made to a destination entered in the user configuration.
- CFNR can also be effected for both types if user B is busy. For this the option *CFNR if busy* must be activated in A's user configuration.

Detailed Description

Tab. 158 Call Forwarding on No Reply

Interface	Operating sequence / signalling on the terminal	Scope
B	Once the feature has been activated, B obtains an acknowledgement tone.	Possible destinations: <ul style="list-style-type: none"> • Users: internal, external¹⁾, PISN • Coded ringing • UG: 17 to 21 (System 2065: 25 to 29) and user groups configured as "large". Requirement: C is not protected against calls (Do not disturb, *26) or Call Forwarding Unconditional (*02).
C		

¹⁾ If caller A is an external user or a virtual network PISN user, the settings authorising exchange-to-exchange traffic (see "Call Forwarding Unconditional to exchange", page 342) will have to be observed. (If the connection is not authorized, the call is not forwarded.)



Note:

The internal number of a call distribution element can only be used as the destination for a CFNR in a special case, namely if at least one CDE destination is configured on ACD. If not, *Not available* is displayed whenever the function is activated. Any configured CDE destinations that are not ACD are never executed.

Chain of Call Forwarding on No Reply:

- Internal: CFNRs are not chained together locally (i.e. the call is routed to C but cannot be routed any further).
- Existing CFU call forwarding chains are interrupted by CFNRs.
- In the PISN: CFNR chains within the PISN are possible if B and C are connected to different PINXs.

**Notes:**

- CFNR chains in the PISN result in long ringing times.
- If a forwarding destination is defined under *Default CF if no answer* in the user configuration, it is possible to configure whether CFNR or the default forwarding is to be executed (see also "Default forwarding per user", page 176).

**Tip:**

CFNR immediate ring can be deactivated individually for PISN users. This is useful for instance in the case of externally connected voice mail systems.

CFNR to the exchange

With Call Forwarding on No Reply to the public or private network the user remains activated in his user group.

Incoming calls on the user groups that reach this user are therefore routed to the CFNR destination (this applies to ordinary user groups, not large user groups, see "User Group", page 132).

**Note:**

If in a user group several users have configured CFNR to the exchange, it may not be possible to set up some of the calls. The number of calls that can be set up depends on the resources available at the time (free B channels in the corresponding trunk group).

Functions in prefix dialling

Tab. 159 Call Forwarding on No Reply: Functions

Functions	Function codes
Activate CFNR to user	*61 destination No.
Clear CFNR to user:	#61
Activate CFNR to user last configured	*61#
Clear CFNR to user last configured	#61
Activate preconfigured CFNR	*62
Clear preconfigured CFNR	#62
Activate CFNR to general bell (coded ringing)	*68
Clear CFNR to general bell (coded ringing)	#68
Protect (own set) against CFNR	*02
Allow CFNR (to own set)	#02

System configuration

Tab. 160 Call Forwarding on No Reply: System configuration

Parameter	Parameter value	Remarks
<i>CFNR if busy</i>	Yes / No	
<i>Preconfigured CFNR</i>	<Dest. No.>	User configuration
<i>CFU/CFNR destination</i>	<Dest. No.>	User configuration: Shows the activate destination. The destination number cannot be altered.
<i>CFU/CFNR type</i>	<Call forwarding type>	User configuration: Shows the active call forwarding type. The call forwarding type cannot be altered.
<i>CFNR immediate ring</i>	Yes / No	Valid throughout the system
<i>CFNR forwarding time</i>	<3, 5 or 7 rings>	Valid throughout the system
<i>Rerouting in the Exchange</i>	Yes / No	User configuration
<i>Rerouting in the Exchange</i>	Yes / No	Trunk group configuration

Reference to Other Features

Features:

- "Call Forwarding Unconditional (CFU)", page 339
- "Deflecting a call during the ringing phase (CD)", page 349

9. 4. 4 Deflecting a call during the ringing phase (CD)

Calls intended for B are deflected to destination C during the ringing phase. (CD: Call Deflection). In such cases the call is not forwarded automatically but manually by user B. Unlike CFNR the call is signalled only at destination C after it has been forwarded.



Fig. 184 Forwards a call during the ringing phase

Detailed Description

The response and properties of Call Deflection are similar to those of CFU Unconditional.

Tab. 161 Call Deflection

Interface	Operating sequence / signalling on the terminal	Scope
B	Once the feature has been activated, B obtains an acknowledgement indication on his display.	<ul style="list-style-type: none"> System phones (without Office 10) via the Foxkey ISDN terminals that support the feature
C		



¹⁾ If caller A is an external user or a virtual network PISN user, the settings authorising exchange-to-exchange traffic (see "Call Forwarding Unconditional to exchange", page 342) will have to be observed. (If the connection is not authorized, the call is not forwarded.)

Other properties:

- The internal number of a call distribution element can only be used as the destination for a Call Deflection in a special case, namely if at least one CDE destination is configured on ACD. If not, *Not available* is displayed whenever the function is activated. Any configured CDE destinations that are not ACD are never executed.
- If the called user is busy and the calling user activates call waiting, the call can also be forwarded. The response and the options available are the same as for a user who is free.
- Calls on the line of a key telephone or an operator console cannot be forwarded (exception: the Personal key on an operator console).
- If the call is not answered at the destination, a recall is not made.
- If an attempt is made to forward the call to an invalid or busy internal call number, the function is not executed and the ringing is signalled as before. By contrast Call Deflection to an external user is always executed.

Functions during the ringing phase

Tab. 162 Call Deflection: Functions

Functions	System phones (without Office 10)
Deflecting a call during the ringing phase (Call Deflection)	<ol style="list-style-type: none">  1. 2. The call number is entered via the keypad, using dialling by name, the call list, etc. 3. 

System configuration

Tab. 163 Call Deflection: System configuration

Parameter	Parameter value	Remarks
No settings		

Reference to Other Features

Features:

- "Call Forwarding Unconditional (CFU)", page 339
- "Call Forwarding on No Reply (CFNR)", page 346
- "Call waiting", page 400
- "Reject call", page 351

9.4.5 Reject call

Calls for B are rejected during the ringing phase. This immediately clears down the call set-up and therefore the ringing at B. User A obtains the busy tone.

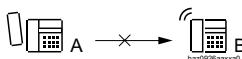

Fig. 185 Rejecting a call during the ringing phase

Detailed Description

Tab. 164 Reject call

Interface	Operating sequence / signalling on the terminal	Scope
B	The activation of the feature is not confirmed.	<ul style="list-style-type: none"> • System phones with display via the Foxkey • ISDN terminals that support the feature. (The response after rejection varies from one manufacturer to the next)

Other properties:

- If the called user is busy and the calling user activates call waiting, the call can also be rejected.
- A configured CFNR, a CFB or an entry in the CDE configuration under *CDE if no answer* or *CDE if busy* are not executed after a call has been rejected.
- If a user who is in a user group along with other users rejects a call, the other users continue to ring (unless *Default call forwarding if rejected* is configured, see

section below). If all the UG members reject the call, the call set-up is cleared down and the calling user obtains the busy tone.

- For each user a *Default call forwarded if rejected* can be configured separately for internal and external calls. Possible redirection destinations include internal or external users, PISN users, abbreviated dialling numbers, user groups, CDE call numbers, etc. This means the response if the call is rejected can vary according to the call's origin, e.g. voice mail for internal calls and transfer for external calls (see "Default forwarding per user", page 176).

Functions during the ringing phase

Tab. 165 Rejecting a call: Function

Function	System phones (without Office 10)
Rejecting a call during the ringing phase	

System configuration

Tab. 166 Rejecting a call: System configuration

Parameter	Parameter value	Remarks
No settings		

Reference to Other Features

Features:

- "Call Forwarding Unconditional (CFU)", page 339
- "Call Forwarding on No Reply (CFNR)", page 346
- "Call waiting", page 400
- "Deflecting a call during the ringing phase (CD)", page 349

9. 4. 6 Twin Mode / Twin Comfort

Twin Mode and Twin Comfort are used to couple a user's desk phone and DECT phone.

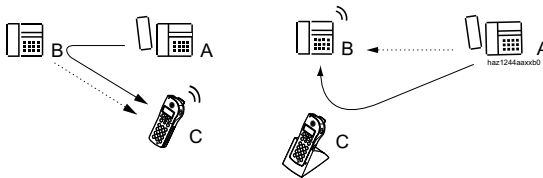

Fig. 186 Twin Mode / Twin Comfort

Twin Mode automatically activates a Call Forwarding Unconditional from user B to user C as soon as the cordless phone (user C) is removed from the charging bay. Conversely, a call for C is automatically diverted to B if C is in the charging bay.

While Twin Comfort provides the same functionality as Twin Mode, it also temporarily replaces the following phone lists of the cordless phones with the corresponding lists of the desk phone:

- Private phone book
- Unanswered call list
- Answered call list
- Last number redial list:
- Message list



Note:

AMS is used to determine whether Twin Mode or Twin Comfort is available on the cordless phone. If the Twin Comfort function is activated, no other function can be allocated to the charging contact; instead it has to be deactivated again via AMS.

Detailed Description

Tab. 167 Twin Mode / Twin Comfort

Interface	Operating sequence / signalling on the terminal
C	<ul style="list-style-type: none"> • Activating via the charging bay • <i>Twin Mode</i> or <i>Twin Comfort</i> indicated on the terminal display

Twin Mode/Twin Comfort and Call Forwarding Unconditional:

- Call Forwarding Unconditional on the desk phone takes priority over the Twin Mode/Twin Comfort call forwarding, i.e. call forwarding of the desk phone remains effective even after the handset has been taken out of the charging bay.
- Call Forwarding Unconditional on the cordless phone is subordinated to Twin Mode/Twin Comfort forwarding, i.e. active forwarding on the cordless phone is temporarily replaced with Twin Mode/Twin Comfort forwarding if the handset is put back in the charging bay. When the cordless phone is again removed from the charging bay, call forwarding on the cordless phone is reactivated.

System configuration

Tab. 168 Twin Mode / Twin Comfort: Key configuration

Function type	Note
In AMS or on the cordless phone the charging bay is configured as "Key" for <i>Twin Mode</i> or <i>Twin Comfort</i> .	Twin Mode and Twin Comfort are mutually exclusive.

9.4.7 Do not disturb

To ensure that user B is no longer disturbed, all incoming calls are automatically diverted to an alternative destination C, which has to be specified using the system configuration.

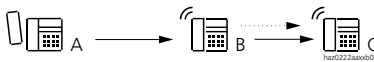

Fig. 187 Do not disturb

Detailed Description

Tab. 169 Do not disturb

Interface	Operating sequence / signalling on the terminal	Scope
B C	Once the feature has been activated, B obtains an acknowledgement tone.	Possible destinations: <ul style="list-style-type: none"> • Users: internal, PISN¹⁾ • Operator console Requirement: C is not protected against calls (Do not disturb, *26) or Call Forwarding Unconditional (*02).

¹⁾ The settings authorising exchange-to-exchange traffic need to be observed for PISN users in the public network or on a virtually connected PINX (see "Exchange-to-Exchange Connections", page 223). (If the connection is not authorized, the call is not forwarded.)

C is the only user who can still reach user B.

The alternative destination C is valid for the entire system.

The Do not disturb destination cannot be forwarded to the exchange.

Functions in prefix dialling

Tab. 170 Do not disturb: Functions

Functions	Function codes
Activate Do not disturb	*26
Clear Do not disturb	#26

System configuration

Tab. 171 Do not disturb: System configuration

Parameter	Parameter value	Remarks
<i>Do not disturb</i>	<CFU destination>	

Reference to Other Features

Features:

- "Call Forwarding Unconditional (CFU)", page 339

9.4.8 Substitution

In the attendant's absence, calls to operator console B can be forwarded to a pre-configured destination C.

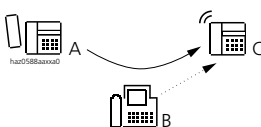

Fig. 188 Proxy activated

Detailed Description

Tab. 172 Substitution

Interface	Operating sequence / signalling on the terminal	Scope
B	<ul style="list-style-type: none"> All the system operator consoles indicate the fact that the proxy is activated. When the proxy is activated, calls are still signalled at the operator console but no longer acoustically. 	Possible interfaces: <ul style="list-style-type: none"> Operator console
C		Possible destinations: <ul style="list-style-type: none"> Users: internal, PISN General Bell Both (user + general bell) Requirement: C is not protected against calls (Do not disturb, *26) or Call Forwarding Unconditional (*02).

The substitution can only be switched on and off at an operator console and is then valid for all the operator consoles in the system.

Personal calls are not diverted.

Calls that were signalled on the operator console before proxy was switched on are not diverted.

If the destination for the substitution is busy, caller A obtains the busy tone. Call waiting is not automatic.

If *General bell* is configured as the destination for the substitution, the call is placed in the general bell's queue and caller A obtains the ring-back tone.

Function in prefix dialling

Tab. 173 Substitution: Function

Function	Office 45 as operator console
Switch proxy on and off	

System configuration

Tab. 174 Substitution: System configuration

Parameter	Parameter value	Remarks
<i>Substitution</i>	<User No.>	

Reference to Other Features

Features:

- "Call Forwarding Unconditional (CFU)", page 339

9.4.9 DECT Follow Me

The system is such that a DECT call cannot be handed over from one system to another (Handover). However, with the new DECT Follow Me feature the reachability of DECT users in a PISN has been improved. This allows a DECT user to be reached without delay in 4 PINXs (DECT Follow me must not be confused with the feature "Follow me", page 345).

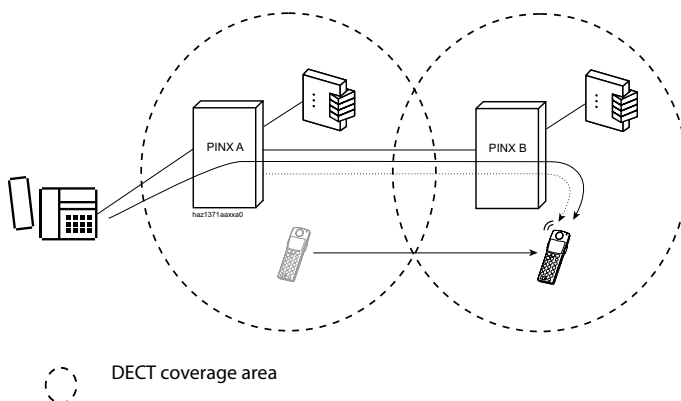

Fig. 189 Automatic activation of DECT Follow me

9.4.9.1 DECT Follow Me in a Network with 2, 3 or 4 Systems

This configuration can be used to find a cordless phone in up to 4 systems without delay. The phone has to be logged on in all 4 systems and the system search mode be configured to *Automatic* on the phone.

Detailed Description:

The cordless phone is logged on under System A on its own communication server and under B, C and D on the other PINXs. On each communication server a number is configured under the corresponding DECT user (*Follow Me Number*) which is di-

alled automatically as soon as the phone registers with the system. On a PINX this activates call forwarding from its own communication server to the communication server on which the cordless phone has just registered. If the phone then registers on its own communication server, the previously activated call forwarding is deactivated.

Other properties:

- Twin Mode is possible on one's own communication server
- Not possible in virtual networks
- Possible only with Office 135 and Office 160



Notes:

- If the *Follow Me Number* cannot be dialed when the handset registers with a system, because the QSIG link is either interrupted or overloaded, the phone will be unable to register. It will continue trying until registration is successful.
- With Office 135 and Office 160 "Long-Click 1" switches over only temporarily to manual search of the next system. What is relevant is the setting in the phone's configuration menu. This prevents accidentally switching the phone over from *Automatic* to *Manual* system search and therefore unintentionally deactivating DECT Follow Me.

The following configuration option can be used as an alternative to DECT Follow me in a network with only 2 systems:

CFU if Unobtainable in a Network with 2 Systems

If most of the phone calls are made in the same system, a destination for unobtainable can be used for the user to find the cordless phone on the second system:

- The phone has the same internal number in both systems.
- With the first call the diversion takes approx. 13 seconds. The diversion is immediate as of the second call.
- Twin Mode is possible on one's own communication server
- Also possible in virtual networks



Application Notes:

Application Notes are available for both configuration options (see <https://pbxweb.aastra.com>)



Aastra Intelligent Net:

In an AIN the availability of the cordless phones across all the nodes is guaranteed even without the "DECT Follow me" feature (network-wide roaming). The phones are automatically registered whenever there is a switch from the coverage range of one node to that of another, and can then be called directly on the new node. Twin Mode/Twin Comfort between the nodes is also supported. However DECT handover between the nodes is not possible.

9. 4. 10 Organising absences on the workstation

The presence profiles allow a user A to manage his incoming calls individually, taking his presence status into account. When he leaves his workstation for example, he can activate the presence profile provided for absences. The presence status can be polled directly from user B without having to make a call. The detailed information depends on the type of phone.

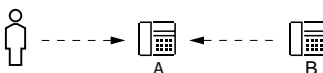

Fig. 190 Dialling by name

Detailed Description

Tab. 175 Presence

Interface	Operating sequence / signalling on the terminal	Scope
A	Activating the presence status: <ul style="list-style-type: none"> • Via the presence menu • Using the presence key or another function key • With a function code The activated status is indicated on the display.	Possible interfaces: <ul style="list-style-type: none"> • Internal
B	Displaying A's presence status: <ul style="list-style-type: none"> • For internal calls (prior to the call) • In the call lists • During dialling by name • On team keys 	Possible system phones: <ul style="list-style-type: none"> • Aastra 5300, Aastra 5300ip, Aastra 600d, Aastra 6700i, Aastra 2380ip

Presence profiles

The following predefined presence profiles are available:

- *Available* (default setting)
- *Meeting*

- *Not available*
- *Absent*
- *Busy*

Action commands

Presence profiles contain action commands that are executed by the user when the presence status is activated. This may be a Call Forwarding Unconditional (CFU) to a call number or to voice mail and/or a predefined personal call routing. It is also possible to retain or deactivate any call forwarding that may be defined for the user.



Note

In connection with CFUs the CFU last carried out is always active. Example: A presence profile with a CFU to voice mail is currently activated. CFU to a user is then carried out. An incoming call is now routed to this user even if the presence profile is still active. The presence profile has to be activated once again before the CFU changes back to voice mail.

Absence information

If CFU to voice mail is configured for a presence profile, you can select whether the caller should obtain the greeting currently active, the global greeting, one of the personal greetings or an absence information. The absence information consists of a predefined audio text that depends on the language used. The date and time are also provided as an option. The caller then has the possibility of leaving a message - provided the global greeting is configured accordingly.

Example: "The subscriber you have dialled is not available until 2 pm on 31 January. Please leave a message after the tone."







Note

The date and time are never provided with the global greeting and the personal greetings.

Functions in prefix dialling

Tab. 176 Presence status: Functions

Function	System phones within the scope	Other terminals
Activate presence status		*27 x hhmm ddmm #
Activate presence status (without date)		*27 x hhmm #
Activate presence status (without time/date)		*27 x #
Deactivate presence status		#27 or *27 0 #

x = profile number: 0 = Available (default), 1 = Absent, 2 = Meeting, 3 = Busy, 4 = Not available

hhmm = time in 24-hour format, ddmm = date indication (day-month)

System configuration

Tab. 177 Presence Profiles User configuration

Parameter	Parameter value	Remarks
<i>Description</i>	<Text>	An additional text can be typed in here to be displayed to the caller in addition to the presence status. Example: "I'm in the laboratory."
<i>Call forwarding type</i>	<Retain settings / No CFU / *21 to call number / *21 to voice mail>	<i>Retain settings:</i> A call is routed in accordance with the user settings. <i>Do not redirect:</i> Any configured call forwarding action is deleted. <i>*21 to call number:</i> A call is routed to the defined forwarding destination. <i>*21 to voice mail:</i> A call is routed to voice mail. The parameter <i>Voice mail greeting</i> is used to configure which greeting is played back.
<i>Call forwarding destination</i>	<Call number>	Can only be defined if the <i>call forwarding type</i> on *21 is on call number. The same destinations are possible as for ordinary CFUs.
<i>Personal call routing</i>	<None / Activate>	This specifies whether or not the presence profile is also to activate a personal call routing.
<i>Call routing ID</i>	<1...5>	Number of the personal call routing
<i>Voice mail greeting</i>	<Retain settings / Absence information / Global greeting / Personal greeting 1 ¹⁾ / Personal greeting 2 ¹⁾ / Personal greeting 3 ¹⁾ >	<i>Retain settings:</i> The greeting used is the one currently set with the user. <i>Absence information:</i> The caller is played an absence information (as well as the date and time if so configured in the activated presence profile ²⁾). <i>Global greeting:</i> The caller is played the global greeting. <i>Personal greeting 1...3:</i> The caller is played one of the personal greetings.
<i>State</i>	<Activated / Deactivated>	One of the 5 presence states can be activated here.

- 1) If the personal greeting was given a different name, that name is listed in the selection.
- 2) The date and time cannot be entered with AMS; this is only possible using a system phone.

Reference to Other Features

Features:

- "Call Forwarding Unconditional (CFU)", page 339
- "One Number user concept", page 337
- "Voice mail system", page 382

9.5 Connections involving several users

9.5.1 Music on hold

In the following chapters a user is put on hold in each case in connection with the features Hold, Brokering, Three-Party Conference and Call Transfer. Depending on the configuration selected for the parameter *Music on hold* the user on hold will obtain the following:

Tab. 178 Parameter values for *Music on hold*

<i>none</i>	The user hears nothing.
<i>External audio source</i>	Music from the audio equipment connected to the communication server's audio input.
<i>Internal audio source</i>	Internal melody from wave file (replaceable)
<i>Hold tone</i>	Regularly recurring dual tone.

The volume of the internal or external audio source can be regulated at 8 levels in AMS.

A standard wave-file melody ("moh.wav") is available in AMS for the internal melody. It can be replaced by another file if required. There is the possibility of recording a text via the phone or to feed in audio data via an audio device connected to the audio input (Aastra 415/430) or an FXS interface in the *External audio source* (Aastra 470 mode).

It is also possible to record an audio file with a PC, store it as a wave file, and then upload it on to the communication server.



Aastra Intelligent Net:

In an AIN the settings can be configured for each node. In this way, various melodies can be loaded and played per node. When possible, for *Music on hold* for external terminals the resources of the node are used where the terminal is located and for external terminals the resources of the node via the exchange accesses from which the call comes.

Tab. 179 Music on hold: Recording functions

Functions	Function codes ¹⁾
Recording with the phone	*914 [*nn] #
Record with audio device	*924 [*nn] #
Check recording	*#914 [*nn] # or *#924 [*nn] #
Delete recording	#914 [*nn] # or #924 [*nn] #

¹⁾ "[]" the digits inside the brackets are optional

"nn" stands for the node number. If no node number is indicated, the node used is that of the terminal with which the function codes are carried out. With IP system phones this is always the Master; with cordless phones it is the node at which the phone is currently located.



Note

A user can only carry out the function codes if he has been allocated an authorization profile with the right *Audio services*. Also the user PIN must not be set to the default value "0000".

Exception: The function for checking the recording is not affected by this restriction.

Recording with the phone:

After the function code is entered, a start tone is audible and can be recorded over the handset.



Note:

Loss of quality is to be expected when recording using DECT, IP or SIP phones.

Recording with audio equipment:

After the function code is entered, a start tone is audible, and it can be played back over the audio equipment connected to the audio input on the communication server. The recording can be monitored via the handset.

The following applies to both recording possibilities:

- To end the recording, hang up; on system phones press the *Stop* Foxkey. The recording is then stored automatically.
- The recording time is limited by the size of the reserved memory defined for *Music on hold* in the communication server file system. Once this time has expired, the recording stops automatically and the audio data is stored.

Recording with the PC:

An audio file can also be recorded with a PC through a connected microphone (e. g. with the Windows Audio Recorder). The recordings have to be stored as wave files in a particular format under a predefined name.

- Format: CCITT A-Law, 8 kHz, 8 bit, mono
- File name: moh.wav (lower case required)

The wave file must be uploaded onto the communication server's file system:

1. From the AMS Shell select the communication server, enter the access data and log in.
2. In the AMS shell under *Tools - Manage audio data - Upload audio data - Upload files for music on hold only*, use the *Add* button to select the "moh.wav" file.
3. Use *Upload* to load the files onto the file system.

The file is available to the application as soon as they are on the communication server file system. We recommend that you use the corresponding function codes to check the file by listening to it (see [Tab. 179](#)).



Notes:

- Wave files with incorrect format cannot be played.
- Wave files that are longer than the time available as defined in AMS under *CM_7.2_File management* cannot be loaded and will generate a corresponding error message.



Tips:

- Before it is used for the first time, the wave file is automatically renamed moh.used.wav. This allows a new audio file to be uploaded to the file system while the audio file is in use. Before an audio file is restarted a check is carried out to see whether the file system contains a new file with the name (moh.wav). If so, the old file is deleted, and the new file is renamed and played back.

- To prevent an existing file from being overwritten, the moh.wav file can first be renamed in the communication server's file system using AMS under CM_7.2_File management. This means several files can be uploaded and used as required.

9.5.2 Hold (enquiry call)

An A – B connection is put on hold if one of the callers, e.g. user B wants to set up an enquiry call connection with C.

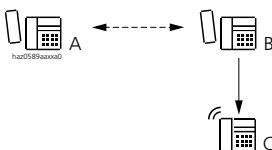

Fig. 191 Putting a call on hold

Detailed Description

Tab. 180 Hold (enquiry call)

Interface	Operating sequence / signalling on the terminal	Scope
A	<i>Music on hold</i> is played to user A, who is on hold ¹⁾	Possible interfaces: internal, external, PISN
C		Possible interfaces: internal, external, PISN

¹⁾ With hold in the public exchange, the signalling depends on the network provider.

If A is on hold and B hangs up before setting up a ringing or call connection to C, B's terminal will ring continuously for 10 seconds. As soon as B picks up the handset, he is again connection with A.

If A is on hold and B waits for more than 10 seconds before setting up a ringing or call connection to C, B will obtain the busy tone. The return to the initial connection is not automatic.

Suffix dialling functions

Tab. 181 Hold (enquiry call): Functions

Functions	System phones	Analogue terminal
Set up internal enquiry call	 with or without call preparation	R <user No.> (R = control key)
Set up enquiry call to a user of the up-circuit communication server. (Requirement: The user's own communication server is analogously connected down-circuit and the existing call connection already seizes a trunk line to the up-circuit communication server)	via function key with function command "I" to seize the line (macro "I*42")	R*42 <user No.>

System configuration

Tab. 182 Hold (enquiry call): System configuration

Parameter	Parameter value	Remarks
<i>Hold in the exchange</i>	<i>Yes / No</i>	<ul style="list-style-type: none"> In the group configuration. Local feature does not require a setting
<i>Music on hold</i>	<i>No music / External audio source / Internal audio source / Hold tone</i>	Throughout the system

Reference to Other Features

Features:

- "Brokering (switching back and forth between two calls)", page 368
- "Enquiry call with return to initial call", page 367
- "Three-party conference from an enquiry call", page 369
- "Call transfer (switching)", page 373
- "Recall", page 379
- "Call acceptance", page 381

9.5.3 Enquiry call with return to initial call

A user (B) can initiate an inquiry call connection during a call (A – B) and as a result hold a short conversation with another call partner (C), without interrupting the first connection. The original connection is restored once the enquiry call is completed.

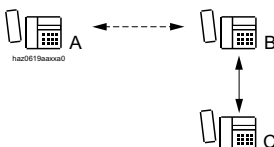

Fig. 192 Enquiry

Detailed Description

Tab. 183 Enquiry call with return to initial call

Interface	Operating sequence / signalling on the terminal	Scope
A	<i>Music on hold</i> is played to user A, who is on hold ¹⁾	Possible interfaces: internal, external, PISN
C		Possible interfaces: internal, external, PISN

¹⁾ With hold in the public exchange, the signalling depends on the network provider.

Suffix dialling functions

Set up enquiry call: see "Hold (enquiry call)", page 365.

Tab. 184 Enquiry call with return to the initial call: Function

Function	System phones	Analogue terminal
Return to the initial call	with the disconnect key	<ul style="list-style-type: none"> with R1 (R = control key) or wait for more than 2 seconds after pressing the control key by putting the handset on-hook and then taking it off-hook again after recall

System configuration

Tab. 185 Enquiry call with return to the initial call: System configuration

Parameter	Parameter value	Remarks
<i>Hold in the exchange</i>	<i>Yes / No</i>	<ul style="list-style-type: none"> In the group configuration. Local feature does not require a setting
<i>Music on hold</i>	<i>No music / External audio source / Internal audio source / Hold tone</i>	Throughout the system

Reference to Other Features

Features:

- "Hold (enquiry call)", page 365
- "Brokering (switching back and forth between two calls)", page 368
- "Three-party conference from an enquiry call", page 369
- "Call transfer (switching)", page 373
- "Call waiting", page 400

9.5.4 Brokering (switching back and forth between two calls)

A user can switch back and forth as often as required between his call party and the user on hold.

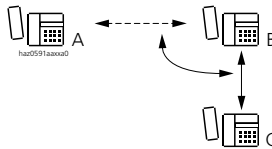

Fig. 193 Brokering

Detailed Description

Tab. 186 Brokering (switching back and forth between two calls)

Interface	Operating sequence / signalling on the terminal	Scope
A	<i>Music on hold</i> is played to user A, who is on hold ¹⁾	Possible interfaces: internal, external, PISN
C		Possible interfaces: internal, external, PISN

¹⁾ With hold in the public exchange, the signalling depends on the network provider.

Brokering is also possible from a conference to a user.

Suffix dialling function

Tab. 187 Brokering (switching back and forth between two calls): Function

Function	System phones	Analogue terminal
Brokering	<ul style="list-style-type: none"> • With digit suffix dialling: 2 	R2 (R = control key)

System configuration

Tab. 188 Brokering: System configuration

Parameter	Parameter value	Remarks
<i>Hold in the exchange</i>	<i>Yes / No</i>	<ul style="list-style-type: none"> In the group configuration. Local feature does not require a setting
<i>Music on hold</i>	<i>No music / External audio source / Internal audio source / Hold tone</i>	Throughout the system

Reference to Other Features

Features:

- "Hold (enquiry call)", page 365
- "Enquiry call with return to initial call", page 367
- "Three-party conference from an enquiry call", page 369
- "Call transfer (switching)", page 373

9.5.5 Three-party conference from an enquiry call

In an enquiry call (with A on hold), B can set up a three-party conference with C.

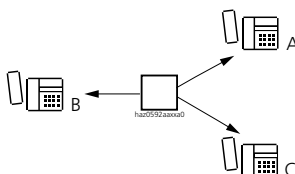

Fig. 194 Three-party conference

Detailed Description

Tab. 189 Three-party conference (conference from enquiry call)

Interface	Operating sequence / signalling on the terminal	Scope
A, C	Depending on the system configuration the conference participants will obtain ¹⁾ : <ul style="list-style-type: none"> • no tone at all • the conference tone only once • the conference tone regularly 	Possible interfaces: internal, external ²⁾ , PISN

¹⁾ With three-party conference in the public exchange, the signalling depends on the network provider.

²⁾ If both users A and C are external users or virtual network PISN users, the settings authorising exchange-to-exchange traffic will have to be observed (see "Exchange-to-Exchange Connections", page 223").



Notes:

- From within an existing three-party conference, up to three conference participants can be connected by further enquiry calls.
- Conferences take up hardware resources.

Suffix dialling functions

Tab. 190 Three-party conference (conference from enquiry call): Functions

Functions	System phones	Analogue terminal
Set up three-party conference	<ul style="list-style-type: none"> • Use digit suffix dialling: 3 • With digit suffix dialling: 5 	R 3 (R = control key)
Three-party conference in the exchange: Return to enquiry call	<ul style="list-style-type: none"> • With digit suffix dialling: 2 	R 5 (R = control key)
Three-party conference in the exchange: Return to enquiry call with brokering	<ul style="list-style-type: none"> • With digit suffix dialling: 2 	R 2 (R = control key)
End three-party conference in the exchange	<ul style="list-style-type: none"> • hang up • Disconnect key 	<ul style="list-style-type: none"> • hang up

System configuration

Tab. 191 Three-party conference: System configuration

Parameter	Parameter value	Remarks
<i>Hold in the exchange</i>	<i>Yes / No</i>	<ul style="list-style-type: none"> • In the group configuration. • Local feature does not require a setting
<i>Three-party conference in the exchange (3PTY)</i>	<i>Yes / No</i>	<ul style="list-style-type: none"> • In the group configuration. • Local feature does not require a setting
<i>Conference / intrusion / call waiting tone</i>	<i>Repeated / Off / Once only</i>	Throughout the system

Reference to Other Features

Features:

- "Hold (enquiry call)", page 365
- "Conference", page 371

9.5.6 Conference

User A can set up a conference call with several users. This can be done in three different ways:

- Variable conference: Here the conference participants are all listed in the same dialling string and are all called up at the same time.
- Preconfigured conference: Here the conference participants are preconfigured in the system configuration and are all called up at the same time.
- Three-party conference (conference from enquiry call): The conference is set up one participant at a time. The participants in the conference are called one after the other and connected individually (see "[Three-party conference from an enquiry call](#)", page 369).

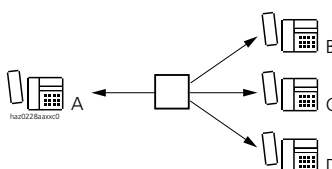

Fig. 195 Conference

Detailed Description

Tab. 192 Variable and preconfigured conference

Interface	Operating sequence / signalling on the terminal	Scope
A	The conference leader obtains a ring-back tone when setting up the conference.	
B, C, D	<p>The preconfigured or dialled conference participants obtain ringing signalling during the conference setup and during the conference - depending on the system configuration¹⁾:</p> <ul style="list-style-type: none"> • no tone at all • the conference tone only once • the conference tone regularly 	<p>Possible interfaces: internal, external^{2) 3)}, PISN⁴⁾</p> <p>Restrictions:</p> <ul style="list-style-type: none"> • Three conference participants (up to a maximum of 6) are permitted per conference⁵⁾. • Abbreviated-dialling numbers are not permitted

¹⁾ With three-party conference in the public exchange, the signalling depends on the network provider.

²⁾ If more than one external user is to be switched into a conference, the settings authorising exchange-to-exchange traffic need to be observed (see "[Exchange-to-Exchange Connections](#)", page 223).

³⁾ With three-party conference in the public exchange, only external interfaces are possible.

⁴⁾ The settings authorising exchange-to-exchange traffic need to be observed for PISN users in the public network or on a virtually networked PINX (see "[Exchange-to-Exchange Connections](#)", page 223).

5) Only three conference participants are permitted if three-party conference in the public exchange is activated.



Notes:

- If the conference tone is deactivated in the system configuration, a conference participant who is intruded upon will not hear an attention tone. Observe the national data protection regulations. With a three-party conference in the public exchange, the signalling depends on the network provider.
- Variable and preconfigured conference:
If a user is redirected or if he has activated CFNR, he will not be included in the conference. In a preconfigured conference the conference participant in question will be removed temporarily from the conference group. The *External priority* parameter is not taken into account.

Functions

Tab. 193 Suffix dialling functions

Functions	System phones	Analogue terminal
Set up conference from enquiry call (three-party conference, three-party conference in the public exchange)	<ul style="list-style-type: none"> • • Use digit suffix dialling: 3 	with R3 (R = control key)
Expand conference from enquiry call:	<ul style="list-style-type: none"> • • Use digit suffix dialling: 3 	with R3
Exclude internal conference participants. The external connection is maintained. Note: PISN users are not excluded.	#71	with R#71

Tab. 194 Conference: Functions in prefix dialling

Functions	Function codes
Set up preconfigured conference	*70 conf. No. (1...4)
Set up variable conference	*71 <User No. 1> * <User No. 2> * ... <User No. 5 #>



Tip:

With a variable conference with several external conference participants, the maximum number of 32 digits is reached quickly. Remedy: Use PISN users or integrated mobile phone users are conference participants.

System configuration

Tab. 195 Conference: System configuration

Parameter	Parameter value	Remarks
<i>Conference</i>	Member <user No.> for group <1 to 4>	
<i>Conference / intrusion / call waiting tone</i>	<i>Repeated / Off / Once only</i>	Throughout the system

Reference to Other Features

Features:

- "Three-party conference from an enquiry call", page 369

9.5.7 Call transfer (switching)

Users A and B are in a call. User B hands over the call with or without prior notice to user C.



See also:

For more information on the switching functions and the operator consoles, see "Operator console", page 145.

9.5.7.1 Call transfer with prior notice

A user B can transfer a call with user A to user C after an enquiry call. In this transfer type user B waits for user C to answer (he gives notice of the call) before handing over the call.

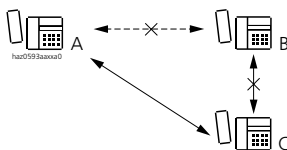

Fig. 196 Call transfer with prior notice

Detailed Description

Tab. 196 Call transfer with prior notice

Interface	Operating sequence / signalling on the terminal	Scope
A	If A is on hold, he hears <i>Music on hold</i>	Possible interfaces: internal, external ¹⁾ , PISN ²⁾
B	If C hangs up during the enquiry call, B obtains the busy tone.	
C	Internal call / external call ³⁾	Possible interfaces: internal, external ¹⁾ , PISN ²⁾

¹⁾ If both A and C are external users, the settings authorising exchange-to-exchange traffic will need to be observed (see "[Exchange-to-Exchange Connections](#)", page 223).

²⁾ The settings authorising exchange-to-exchange traffic need to be observed for PISN users in the public network or on a virtually networked PINX (see "[Exchange-to-Exchange Connections](#)", page 223).

³⁾ Depending on the system setting, C will obtain either an internal or an external ringing tone

If C and B hang up before the call transfer has been made, B will obtain 10 seconds of continuous ringing.

Suffix dialling function

Tab. 197 Call transfer with prior notice: Function

Function	All terminals
Call transfer	hang up

System configuration

Tab. 198 Call transfer with prior notice: System configuration

Parameter	Parameter value	Remarks
<i>Hold in the exchange</i>	<i>Yes / No</i>	<ul style="list-style-type: none"> • In the group configuration. • Local feature does not require a setting
<i>Call transfer in the exchange (ETC)</i>	<i>Yes / No</i>	<ul style="list-style-type: none"> • In the group configuration. • Local feature does not require a setting
<i>Music on hold</i>	<i>No music / External audio source / Internal audio source / Hold tone</i>	Throughout the system

Reference to Other Features

Features:

- "Hold (enquiry call)", page 365
- "Call acceptance", page 381

9.5.7.2 Call transfer without prior notice

A user B can transfer a call with user A to user C after calling user C. In this transfer type user B does not wait for user C to answer (he does not notice of the call) before handing over the call.

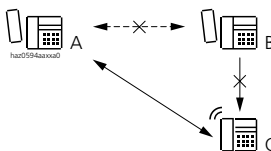

Fig. 197 Call transfer without prior notice

Detailed Description

Tab. 199 Call transfer without prior notice

Interface	Operating sequence / signalling on the terminal	Scope
A	If A is on hold, he obtains the ring-back tone or <i>Music on hold</i> .	Possible interfaces: internal, external ¹⁾ , PISN
B	<ul style="list-style-type: none"> • When B calls user C, he obtains the ring-back tone (B must hear this tone before he can hand over the call) • On the operator console the line is signalled as switched until user C answers the call or a recall takes place. 	
C	Internal call / external call	

¹⁾ If both users A and C are external users or virtual network PISN users, the settings authorising exchange-to-exchange traffic will have to be observed (see "Exchange-to-Exchange Connections", page 223").

If the call is not answered by C within the configured recall time and C is an internal user, the call will ring again at B (see "Recall", page 379). If the recall is not answered within 15 s, the call is rerouted to Capolinea.¹⁾

¹⁾ Only in Italy

Suffix dialling function

Tab. 200 Call transfer without prior notice: Function

Function	All terminals
Call transfer	hang up

System configuration

Tab. 201 Call transfer without prior notice: System configuration

Parameter	Parameter value	Remarks
<i>Handover without notification</i>	<i>Ring / Hold</i>	The value determines whether the caller obtains the ring-back tone or <i>Music on hold</i> .

Reference to Other Features

Features:

- "Hold (enquiry call)", page 365
- "Recall", page 379

9. 5. 7. 3 Call transfer if busy

A user B can hand over a call with user A to the busy user C after making an enquiry call to C by activating a recall and then hanging up. As soon as the busy user C is free again, C's phone automatically begins to ring. When C answers, he is connected with A.

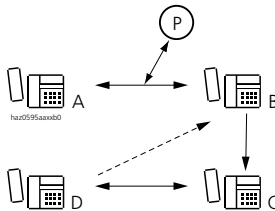

Fig. 198 Call transfer if busy

Detailed Description

Tab. 202 Call transfer if busy

Interface	Operating sequence / signalling on the terminal	Scope
A	If A is on hold, he hears <i>Music on hold</i>	Possible interfaces: internal, external ¹⁾ , PISN ²⁾
B	<ul style="list-style-type: none"> • After the enquiry call to C, B obtains a busy tone. • After recall has been activated B obtains an acknowledgement tone. • On the operator console the line is signalled as switched until user C answers the call or a recall takes place. 	
C		

¹⁾ If both A and C are external users, the settings authorising exchange-to-exchange traffic will need to be observed (see "Exchange-to-Exchange Connections", page 223).

²⁾ The settings authorising exchange-to-exchange traffic need to be observed for PISN users in the public network or on a virtually networked PINX (see "Exchange-to-Exchange Connections", page 223).

³⁾ For users in the public network or reached via the public network, the feature Callback if busy (CCBS) must be supported end-to-end by the public network.

If user B signals call waiting to C and then goes on hook, the call with A is transferred. This applies only if C does not reject B's call. For the full scope of this feature see "Call waiting", page 400.

If the call is not answered by C within the configured recall time (C still busy or does not answer), B again obtains ringing (see "Recall", page 379).

If user B intrudes on C's call and then goes on-hook, the call with A is also transferred. This applies only if C neither rejects nor answers B's call. For the full scope of this feature, see "intrusion", page 402.

Suffix dialling functions

Activate callback: see "Callback if user busy / free", page 427.

Tab. 203 Call transfer if busy: Function

Function	All terminals
Call transfer if busy	Activate callback and go on-hook

System configuration

Tab. 204 Call transfer if busy: System configuration

Parameter	Parameter value	Remarks
<i>Music on hold</i>	<i>No music / External audio source / Internal audio source / Hold tone</i>	Throughout the system

Reference to Other Features

Features:

- "Hold (enquiry call)", page 365
- "Callback if user busy / free", page 427
- "Recall", page 379
- "Call waiting", page 400
- "intrusion", page 402

9.5.8 Recall

Recall reminds a user that a call has been transferred but not answered.

Recall is triggered if the internal user does not respond within the recall time in the case of transfer without prior notice.

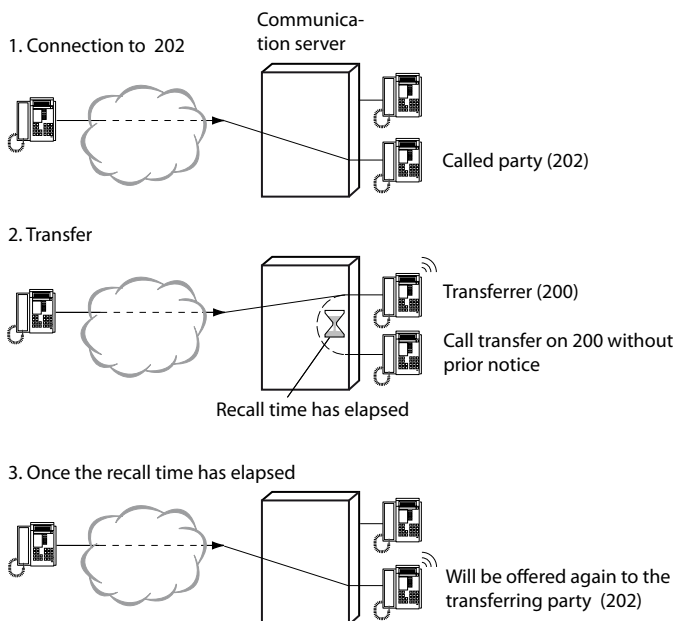

Fig. 199 Recall time

The recall time is defined throughout the system. A recall time can also be configured individually for each user. The recall time defined for the switched user 200 takes priority. A recall to user 202 is triggered once that time has elapsed.

In some cases the recall time used depends on the type or the configuration of the switched user 200:

If the transferred user is

- not an individual internal user but in a user group with several other users, the recall time defined throughout the system is used.
- a PISN user or an external user, the recall time defined throughout the system is used.
- a virtual user and if no recall time has been defined for that user, a separate recall time defined throughout the system for virtual users is used.

If the transferred user has

- activated *CFU* or *CFB*, the recall time used is the one defined at the CFU destination.
- activated *CFNR* or *Default CF if no answer*, the switched user's own recall time is used.
- forwarded the call during the ringing phase (Call Deflection), the switched user's own recall time is used.

A recall is also triggered if a parked call is not retrieved within the monitored parking time.

System configuration

Tab. 205 Recall: System configuration

Parameter	Parameter value	Remarks
<i>Recall time normal</i>	<10 to 240 seconds>	Throughout the system
<i>Recall time, virtual user</i>	<10 to 999 seconds>	Throughout the system
<i>Recall time</i>	<10 to 999 seconds>	User setting



Note:

If the value of the *Internal ringing duration* parameter is smaller than the corresponding recall time, the call connection is cleared down and the recall is not carried out. In the case of forwarding with a time delay (e. g. *Call Deflection* or *Default CF is no answer*) the timer is restarted (see also "*Internal ringing duration*", page 167).

9.5.9 Call acceptance

An internal user C can accept a connection with user A after being contacted in an enquiry call by user B, who was connected with A.

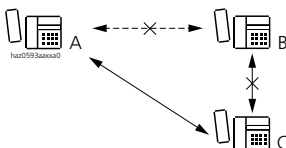

Fig. 200 Call acceptance

Detailed Description

Tab. 206 Call acceptance

Interface	Operating sequence / signalling on the terminal	Scope
B C	<ul style="list-style-type: none"> As soon as C has answered the call, B obtains the busy tone 	Possible interfaces: Internal Possible terminals: Analogue terminals

Suffix dialling function

Tab. 207 Call acceptance: Function

Function	Analogue terminal
Call acceptance	<ul style="list-style-type: none"> with R1 (R = control key) or wait for more than 2 seconds after pressing the control key

System configuration

Tab. 208 Call acceptance: System configuration

Parameter	Parameter value	Remarks
No settings		

Reference to Other Features

Features:

- "Hold (enquiry call)", page 365

9.6 Added features

9.6.1 Voice mail system

9.6.1.1 Overview

Basic voice mail system

A basic voice mail system is included in the basic configuration of every Aastra 400 system. Essentially it provides the functions of an answering machine. Each mailbox owner has up to three personal greetings which he can record himself using a phone. In this way the appropriate greeting can be selected according to the absence situation. Depending on the mailbox configuration the caller may or may not have the possibility of leaving a voice message after the greeting.

The mailbox owners are notified of any voice messages received, which they can then retrieve and/or delete, or call back the callers directly. If the system phone connected is equipped with a display, the call number (CLIP), name (where available), date and time of the voice message received are also displayed. An Audio Guide is also available, providing information on the number, date, time and CLIP of new messages when you play back your new messages.

On system phones with a display it is operated and configured using the Foxkey; on all other terminals, using */# function codes and suffix dialling (DTMF). Remote retrieval and remote configuration are also possible.

An individual Automated Attendant can be stored with each greeting so the caller is routed to correct destination. The licence *Auto Attendant* is required for this purpose.

The basic voice mail has 2 voice channels and a recording capacity of 20 minutes. For more channels, more storage space or more functionality the *Enterprise Voice Mail* licence is required.

Enterprise voice mail system

If the basic voice mail system is expanded using the *Enterprise Voice Mail* licence, the maximum recording capacity is increased, adding the possibility of e-mail notification whenever new voice messages are received. If required, the voice messages can also be sent as attachments. It is also possible to deflect received voice messages to another user using the Foxkey of a system phone or via the voice mail menu. Possible destinations are users with their own voice mailbox on the same

node. The Enterprise voice mail system can also be used to record conversations (see "[Conversation recording](#)", page 452).

If an *Auto Attendant* licence is in place, the voice channels can be used not only for voice mail and for recording calls but also for the Auto Attendant. Additional *Audio Record & Play Channels* licences are required for more than two voice channels.

9.6.1.2 Voice memory capacity and voice channels

The voice memory capacity and the maximum number of voice channels for voice mail and/or Auto Attendant depend on the existing licences, the type of communication server and, with Aastra 415/430, also on the *Voice mail mode* configured. In an AIN the indications are valid for each node:

Tab. 209 Voice memory capacity

Features	Basic voice mail	Enterprise voice mail with Aastra 415/430	Enterprise voice mail with Aastra 470
Voice memory capacity [Minutes]	20	200 ¹⁾ / 400 ²⁾	600
Maximum number of voice channels for voice mail	2	4 ¹⁾ / 12 ²⁾	16
Maximum number of voice channels for Auto Attendant	2	4 ¹⁾ / 12 ²⁾	46
Maximum number of voice channels for recording calls	–	4 ¹⁾ / 12 ²⁾	46

¹⁾ if *Voice mail mode* = *Normal* (G.711 or G.729)

²⁾ falls *Voice mail mode* = *Expanded* (G.729 only)

For the voice channels the appropriate DSP resources need to be allocated on the DSP chips. Without configuration the Aastra 415/430 communication server only provides the two basic voice-mail voice channels. The Aastra 470 communication server has 8 Enterprise voice mail channels in its basic configuration. An Enterprise Voice Mail licence and 6 *Audio Record & Play Channels* licences need to be in place before they can be used.



Notes:

- The configured *Voice mail mode* is always valid for the entire node.
- In *Voice mail mode* = *Expanded* (only G.729) all the voice mail audio data (personal and global greetings, voice messages and the Audio Guide languages) must be in G.729 format so that they can be played back. Existing greetings and voice messages in G.711 format can be converted to G.729 format using the Aastra WAV Converter.

- Voice messages can only be sent as attachments if they are always in G.711 format.
- The Aastra 470 communication server always operates with the G.711 codec setting.



See also:

- The System Manuals of the individual hardware platforms contain the maximum number of voice channels per DSP and node, additional information about the *Voice mail mode*, allocating voice channels and a description of the licences.
- The procedure for converting voice messages and greetings using the Aastra WAV Converter and the procedure for loading the Audio Guide in the correct audio format are described in detailed in the AMS Help.

9.6.1.3 Operation of the voice mail functions

Depending on the phone the voice mail functions are operated either using the Foxkey or */# function codes and digit keys.

Operation via the Foxkey

The mailbox owner can use the Foxkey to record, monitor, activate and deactivate personal greetings on his system phone. The personal greeting that is currently active is indicated accordingly. If no personal greeting is active or available, the global greeting is automatically activated, providing it has been recorded. If not, the system texts of the Audio Guide are played back.

The mailbox owner can give each personal greeting a name and decide for each greeting whether or not the caller is able to leave a message. The current setting is indicated on the display by a tape symbol (with or without strikethrough).

Voice messages can be played back from the voice mail incoming list, deleted or deflected to another user with voice mailbox. Deflected voice messages are marked with an arrow in the voice mail incoming list at the destination. Deflected voice messages are rejected if there is no mailbox at the destination or if there is insufficient space available in the mailbox voice memory.



Aastra Intelligent Net:

If in an AIN the voice data of mailboxes is stored on different nodes, voice messages cannot be exchanged between those mailboxes.

Operation without Foxkey

On phones without a Foxkey (e. g. analogue phones) personal greetings are recorded, monitored and activated in a similar way, but using function codes. Global greetings are always recorded, monitored and activated using function codes (see "[Functions in prefix dialling](#)", page 395).

Greeting texts can also be uploaded into the communication server file system as a wave file as an alternative to recording messages via a terminal (see "[Recording greetings with the PC and uploading them onto the communication system](#)", page 385).

On phones without a Foxkey or on third-party, internal or external phones (remote retrieval), voice messages are listened to, deleted and deflected using the voice mail menu (see "[Suffix dialling functions](#)", page 397).



See also:

More detailed user information on how to activate a mailbox, signal new voice messages, and listen to, delete and deflect voice messages are described in the User's Guide "Voice mail system on Aastra 400".



Note:

New voice messages can also be signalled via e-mail using an e-mail system connected to OIP. The voice message can be sent as a link or wave file. More detailed information can be found in the "Open Interfaces Platform" System Manual.

9. 6. 1. 4 Recording greetings with the PC and uploading them onto the communication system

Greetings can also be recorded with a PC through a connected microphone (e. g. with the Windows Audio Recorder). The recordings have to be stored as wave files in a particular format under a predefined name.

- Format: CCITT A-Law, 8 kHz, 8 bit, mono
- File name, global greeting: greeting_1.wav
- File name, global overflow greeting: greeting_2.wav

The file names must be written in lower case.



Note:

Aastra 415/430 only: If the *Voice mail mode* is on *Expanded (only G.729)*, the Wave files have to be converted to the G.729 format prior to the upload with the Aastra WAV Converter.

The wave files with the greetings must now be uploaded onto the communication server's file system:

1. From the AMS Shell select the communication server, enter the access data and log in.
2. In the AMS shell under *Tools - Manage audio data - Upload audio data - Upload global greetings only*, use the *Add* button to select one or both wave files.
3. Use *Upload* to upload the wave file(s) onto the file system.

The files are available to the application as soon as they are on the communication server file system. We recommend that you use the corresponding function codes to check the texts by listening to it (see [Tab. 219](#)).



Notes:

- Wave files with incorrect format cannot be played.
- Wave files that are longer than the time available as defined in AMS under *CM_7.2_File management* cannot be loaded and will generate a corresponding error message.



Tips:

- Before the announcements are used for the first time, the wave files are automatically renamed (from name.wav to name.used.wav). This allows new greetings to be uploaded onto the file system while greetings are being made. Before an greetings is restarted a check is carried out to see whether the file system contains a new file with the original name (name.wav). If so, the old file is deleted, and the new file is renamed and played back.
- To prevent existing files from being overwritten, they can first be renamed in the communication server's file system using AMS under *CM_7.2_File management*.

9.6.1.5 Audio guide

The Audio Guide provides the date, time and call number of voice messages received and explains the procedure for navigating the voice mail menu when retrieving your own voice messages.

Three Audio Guide languages can be loaded onto the system simultaneously and individually allocated to each mailbox.



Tips:

- You can skip the Audio Guide information using the #-key.
- The information relating to the voice messages can be activated or deactivated for each mailbox using the parameter *Listen to voice message information*.



See also:

The procedure for loading the Audio Guide in the correct audio format is described in detail in the AMS Help.

9.6.1.6 Auto-Attendant

The Auto Attendant is one possibility for carrying out predetermined actions while a greeting is played back. The actions are either initiated by the caller (*DTMF actions*) or triggered by the system itself (*Monitoring actions*).

For each greeting each mailbox can be assigned the profile of an Auto Attendant. The caller then has the possibility for instance of influencing the way in which his call is handled. If he presses one of the digit keys 0...9 while greeting is being played back, the action assigned to that key is carried out immediately. If he presses the #-key or waits for the end of the greeting, the action assigned to the *End of greeting* parameter is carried out.

The parameter *Delay after end of greeting* is used to delay the subsequent action by up to 9 seconds. The delay is not taken into account if the #-key is used to skip to the end of the greeting.

For the actions, in addition to phone number digits, some macros can be entered for destinations:

Tab. 210 Using macros in the destinations

Macro	Meaning
N	The "N" macro allows the caller to carry out suffix dialling. This can be a complete call number or part of the end digits of a call number.
K	With macro "K" the system waits for the user PIN to be entered in the form of *PIN# (this is the PIN of the user whose greeting is being played back).
Gx	If a particular greeting is to be played back, it can be done using the macro "Gx" (x=1,2,3) (usable only with action <i>Switch through to mailbox</i>).

The following actions are possible:

- *none*

The corresponding DTMF character is ignored. With *End of greeting = None* the response depends on whether or not a recording after personal greeting is enabled.

- *Transfer to call number*

The call is transferred to the call number entered in the field *Destination*. Possible destinations include:

- internal call numbers
- external call numbers
- user group call numbers
- CDE call numbers
- PISN user numbers
- Abbreviated dialling numbers

Examples of destinations:

- 333: The call is forwarded directly to call number 333.
- N: The caller obtains an internal dial tone and then enters a call number. All the destinations mentioned above are available to him.
- 42N: The system has already preselected 42. The caller does not obtain a new dial tone; instead he add further digits.
- K334: The system waits for the user PIN (*PIN#) to be entered and afterwards switches through the call number 334.

Special cases:

- No action is carried out if no call number is entered.
- If an invalid call number is entered, the connection is cleared down.

- *Transfer to mailbox*

The call is transferred to the user mailbox number entered in the field *Destination*. The mailbox's active greeting is played back directly.

Examples of destinations:

- 444: The activated greeting for the mailbox of user 444 is played back.
- 555G2: Greeting 2 for the mailbox of user 555 is played back.
- NG3: Greeting 3 for the mailbox of the user selected by the caller is played back.
- K60N: The system waits for the user PIN (*PIN#) to be entered and then dials 60. The caller completes with further digits.

Special cases:

- If no user number is entered, the activated greeting for the active mailbox is played back once again.
 - If the user does not have a mailbox or if an invalid call number is entered, no action is carried out.
- *Leave voice message*
The call is transferred to the user mailbox number entered in the field *Destination*. The mailbox's active greeting is not played back; instead the caller has the possibility of directly leaving a voice message after a prompt tone. Similar to the previously described examples, macros "N" and "K" can also be used.
Special cases:
 - If no user number is entered, the voice message on the active mailbox is recorded.
 - If recording is not enabled with the mailbox's active greeting, a message can still be left.
 - If the user does not have a mailbox or if an invalid call number is entered, no action is carried out.
 - *Carry out function*
This action is used to carry out */# function codes. Only those function codes which the mailbox owner is authorized to use and which are not barred in the digit barring are carried out.

The transfer actions can fail if the destination is busy or does not answer. These cases are caught with the parameters *Busy* and *No answer*. These parameters can again be assigned the actions described above. The action under *No answer* is carried out once the recall time has elapsed.



Note:

The Auto Attendant is active only while a personal greeting is played back. By contrast it is never active with the global greeting.

Interaction with the Call Transfer feature

Situation:

Users A and B are in a call. B makes an enquiry call to C, who has forwarded to voice mail. B presses a key (DTMF action) to establish a connection with user D (case 1, 2) or with the mailbox of user D (case 3, 4).

- Case 1: Call transfer with prior notice
D answers the call and B hangs up.
--> A is connected directly with D.

- Case 2: Call transfer without prior notice
B hangs up even before D has answered the call.
--> As soon as D answers the call, he is connected with A. If D does not answer, a recall is made to B.
- Case 3: User B hangs up while D's greeting is played back.
--> A is connected with D's mailbox. The greeting is played back again.
- Case 4: D's greeting is played back. B leaves a message and hangs up.
--> A is connected with D's mailbox. The greeting is no longer played back, but A can also leave a message.

Note:

If user B hangs up during or after C's greeting, A is connected with C's mailbox. The remaining behaviour is analogous to cases 3 and 4.

In each case user B can return to the first call, i.e. to user A, at any time using the END key or the *Brokering* Foxkey.

9.6.1.7 Scope

- Depending on the configuration the voice mail system has between 2 and a maximum of 16 voice mail channels, i. e. 2 or 16 incoming calls can be handled simultaneously. Other callers obtain the busy tone.
- A mailbox owner can choose from three personal and one global greeting. The relevant greetings must be recorded beforehand and the mailbox owner must have the appropriate authorization in the user configuration.
- Once the total capacity of the voice memory or the maximum recording time configurable for each Mailbox is reached, all subsequent callers forwarded to the voice mail system obtain an overflow greeting. The overflow greeting remains active until memory space is created again by deleting voice messages or greetings.
 - Once the total capacity of the voice memory is 90% full, all the mailboxes are switched over to the overflow greeting until the value drops back below 80%. These percentages are permanently fixed and cannot be modified.
 - The size of the minimum recording capacity of a mailbox before it is switched over to overflow greeting can be configured globally.
- The maximum storage time for new voice messages and voice messages that have already been retrieved can be configured separately and globally.
- The minimum storage time of voice messages so they are stored as such can also be configured globally.

Forwarding in line groups

- If a user who is a member of user group uses CFU to forward to voice mail, the behaviour is the same as if he had used CFU to external or to a PISN user (see "Call Forwarding Unconditional (CFU) for user group members", page 138).
- CFUs to voice mail by line-group members using CFNR do not result in exclusion from the line group. However the forwarding is always carried out after the configured CFNR delay.

Response to call forwarding chains

If user A activates a Call Forwarding Unconditional to user B, who has himself diverted to the voice mail user group, the response depends on the following configuration setting made for user A:

- If the parameter *Last mailbox for CFU/CD* is configured to *No* (default setting), a caller will be connected with the voice mailbox of user A. If user A has not set up a personal voice mailbox, the caller obtains the global greeting text. This response also applies to CFU chains.
- If the parameter *Last mailbox for CFU/CD* is configured to *Yes*, a caller will be connected with the voice mailbox of user B. In CFU chains the user is connected with the voice mailbox of the last user in the chain.

In QSIG networks or voice mail systems connected via QSIG, the response of parameter *Send first/last mailbox information* is dependent on the trunk group settings:

- If the parameter is set to *No*, a call to user A is in any case forwarded to the voice mailbox of user B or to the voice mailbox of the last user in the chain.
- If the parameter is on *Yes*, the response is dependent on the *Last mailbox on CFU/CD* setting made with user A.

Forwarding via call distribution element (CDE)

- Situation 1: (possible configuration)
On a CDE 900, voice mail is configured as the destination. User 30 has a personal mailbox. With CDE 30, user 30 is entered as destination and as CDE 900 overflow. An external call to a direct dialling number that is linked with CDE 30 is forwarded to user 30 in the event of overflow.
- Situation 2: (**configuration to be avoided!**)
On a CDE 900, voice mail is configured as the destination. If an external call is

made to a direct dialling number that is linked to CDE 900, the voice mail system is unable to assign the call to a mailbox and the call is rejected.

9.6.1.8 Access concept

The mailbox owner can carry out his own voice message management and configuration of personal greetings. However a special authorization is required for recording and deleting global greetings. For this a user must be assigned an authorization profile with the administration right *Audio services*. Also the user PIN must not be set to the default value "0000".

Note:

The *Audio services* permission is also used for the *Announcement service* and for *Music on hold*.

9.6.1.9 System configuration

The settings in Tab. 211 apply to all voice mailboxes. They are accessed using the AMS Configuration Manager under menu item 1_6_1.

Tab. 211 Global settings for voice messages

Parameter	Value range	Remarks
<i>Min. recording capacity before overflow</i>	<0..60> sec.	If the free memory space available on a mailbox drops below this value, the system switches over to the overflow greeting
<i>No storage of messages of less than</i>	<0..60> sec.	Minimum length of a voice message for it to be stored.
<i>Storage times for new voice messages</i>	<1..90> days	Older voice messages that have not yet been played back are automatically deleted once the configured time period has expired. The set value is also valid for voice messages that have been retrieved if the parameter <i>Storage time for retrieved voice messages</i> is blank
<i>Storage times for retrieved voice messages</i>	<1..90> days	Older voice messages that have been played back are automatically deleted once the configured time period has expired. The storage time begins on the day on which the voice message is first retrieved, not on the day on which it was spoken.
<i>Global greeting name</i>	<Name>	

The settings in the following tables can be configured for each voice mailbox and can be accessed using the AMS Configuration Manager under menu item 1_6_2. A

new mailbox must first be created. The configured mailbox is then assigned to a user. Both real and virtual users can be assigned.

Tab. 212 General mailbox settings

Parameter	Value range	Remarks
<i>Mailbox name</i>	Mailbox name	Mailbox name
<i>Number of rings before answer</i>	<0..9>	CFU delay until the voice mail system answers the call. With Call Forwarding on No Reply (CFNR) the configured delay must also be added.
<i>Saving voice data on nodes</i>	<0..40>	Indication of the node number if the messages and personal greetings are to be stored on a node other than the one where the terminal of the mailbox owner is currently located. For IP terminals the master nodes are used if no indication. The configuration of other node numbers makes sense, for example, for IP terminals at a satellite location which has an exchange line circuit. (Relevant only in an AIN.) Warning: If the node is changed, all the mailbox's greetings and voice messages are deleted!
<i>Language ID</i>	<0..3 - language>	Here the mailbox is assigned one of a maximum of 3 loaded Audio Guide languages. Requirements: <ul style="list-style-type: none"> • A node is already assigned to the mailbox. • Languages are already loaded on the node. (Only loaded languages of the assigned node can be selected.)
<i>Listen to voice message information</i>	Yes / No	Here you select whether or not the date, time and call number (CLIP) of the voice messages received should be announced before the messages are played back.

Tab. 213 Notification to a system phone

Parameter	Value range	Remarks
<i>Notification of a new voice message</i>	Yes / No	In addition to the entry in the call list a new voice message is also signalled with a text message on the display of a system phone, and the message LED lights up.
<i>Additional Notification to internal call number</i>	<Internal call No.>	A new voice message is also signalled with a text message on the display of another internal system phone and the message LED lights up (user group numbers are also possible as destinations)

Tab. 214 E-mail notification

Parameter	Value range	Remarks
<i>Notification of a new voice message</i>	Yes / No	Newly recorded voice messages generate an e-mail to the user's email address and any additional email destinations that may have been entered. The parameter is configurable only if the user has a valid e-mail address configured.
<i>Attach voice message</i>	Yes / No	An audio file with the recorded voice message is also sent as an e-mail attachment. Note: Audio files are only sent along too if the codec is set to G.711.
<i>Additional destinations (email addresses)</i>	<E-mail address 1, E-mail address 2...>	E-mail notifications are sent to the user's e-mail address as standard. If the e-mail notifications are to be sent to other destinations, enter the e-mail addresses here. Separate the individual e-mail addresses with a comma.

Tab. 215 Mailbox recording capacity

Parameter	Value range	Remarks
<i>Max. capacity</i>	<0.0.3600> sec.	Total recording time available for this mailbox (incl. personal greetings).
<i>Capacity used</i>	<0.0.3600> sec.	Status display

Tab. 216 Greetings

Parameter	Value range	Remarks
<i>Number of personal greetings</i>	<0..3>	The global greeting (setting = 0) is automatically activated if no personal greetings are recorded. If no global greeting is available, the greeting is automatically taken over by the audio guide.
<i>Active greeting</i>	<0..3>	Greeting 1, 2 or 3 can be selected as the active greeting, where permitted. The greeting 0 corresponds to the global greeting.
<i>Max. recording time per greeting</i>	<0.0.300> sec.	Applies only to personal greetings. For global greetings the maximum length is defined in the file management.
<i>Codec greetings</i>	<G.711 (low compression) / G.729 (high compression)>	Choice of compression method: G.711 = high call quality, requires more memory G.729 = lower call quality, requires less memory
<i>Recording after global greeting enabled</i>	Yes / No	Allows the caller to leave a voice message after the global greeting.
<i>Greeting name</i>	<Name>	

Parameter	Value range	Remarks
<i>Recording after greeting enabled</i>	Yes / No	Allows the caller to leave a personal voice message after the global greeting.
<i>Duration</i>	<0.0.300> sec.	Status display greeting x
<i>Profile ID auto attendant</i>	<Profile name>	Each greeting can have a predefined transfer profile assigned to it. The caller then has the possibility for instance of influencing the way in which his call is handled.

Tab. 217 Voice messages

Parameter	Value range	Remarks
<i>Max. recording time per message</i>	<0.0.3600> sec.	Once the configured time period has expired, the recording is stopped and the connection is cleared down.
<i>Number of saved messages</i>	<unrestricted>	Status display
<i>Codec voice messages</i>	<G.711 (low compression) / G.729 (high compression)>	Choice of compression method: G.711 = high call quality G.729 = slightly lower call quality
<i>Entry in unanswered call list</i>	Yes / No	If a call is forwarded to the voice mail system, it is useful if this action generates an entry in the list of unanswered calls with the user concerned, regardless of whether or not the caller has left a message. For this entry to be generated, you need to set the parameter to <i>Yes</i> in the voice-mail user group in the user group configuration.

9.6.1.10 Functions in prefix dialling

Functions for personal greetings

On system phones with a display, personal greetings are recorded, monitored and activated using the Foxkey. The same functions are also available using */# function codes. The user operates the settings on his own terminal:

Tab. 218 Voice mail: Functions for personal greetings

Functions	Function codes ¹⁾	
Recording personal greeting x with phone	*913x [*nn] #	(x = 1, 2, 3)
To record personal greeting x via communication server audio input	*923x [*nn] #	(x = 1, 2, 3)
Check recording	*#913x [*nn] # or *#923x [*nn] #	(x = 1, 2, 3)
Delete recording	#913x [*nn] # or #923x [*nn] #	(x = 1, 2, 3)
Activate greeting	*933x	(x = 1, 2, 3)
Deactivate greeting	#933x	(x = 1, 2, 3)
x = 1, 2, 3: Personal greeting 1, 2, 3		

1) "[]" the digits inside the brackets are optional

"nn" stands for the node number. If no node number is indicated, the node used is that of the terminal with which the functions are carried out. With IP system phones this is always the Master; with cordless phones it is the node at which the phone is currently located.

Functions for global greetings

Global greetings are always recorded, monitored, activated and erased using */# function codes. This requires a special authorization except for monitoring the global greetings. For this the terminal must be assigned an authorization profile with the administration right *Audio services*. Also the user PIN must not be set to the default value "0000". The procedure can be operated on any internal terminals (DTMF / Keypad protocol).

Tab. 219 Voice mail: Functions for global greetings

Functions	Function codes ¹⁾	
Recording global greeting x with phone	*913x [*nn] #	(x = 7, 8)
To record global greeting via communication server audio input	*923x [*nn] #	(x = 7, 8)
Check recording	*#913x [*nn] # or *#923x [*nn] #	(x = 7, 8)
Delete recording	#913x [*nn] # or #923x [*nn] #	(x = 7, 8)
x = 7: global greeting x = 8: global overflow greeting		

1) "[]" the digits inside the brackets are optional

"nn" stands for the node number. If no node number is indicated, the node used is that of the terminal with which the functions are carried out. With IP system phones this is always the Master; with cordless phones it is the node at which the phone is currently located.

Functions for listening to voice messages

Besides the possibility of listening to received voice messages either from the list of unanswered calls, the voice-mail incoming list or by calling the voice mail system, the following function codes are available:

Tab. 220 Voice mail: Functions for listening to voice messages

Functions	Function codes
Listen to voice messages with audio guide	*#94
Listen to voice messages without audio guide	*#916 #

9.6.1.11 Suffix dialling functions

A voice mailbox can also be operated from another internal telephone or an external telephone (DTMF / Keypad protocol) using suffix dialling (DTMF). The only requirement is that calls are forwarded to the voice mailbox and that the relevant PIN is known:

1. Select the user who has forwarded to voice mail.
2. Press the *-key during the greeting text.
3. Enter the PIN.
4. Use the # key to complete.
--> The voice messages are now played back (where available), starting with the most recent message.
5. You can now navigate in the voice mail menu. The table below shows the keys available and what they stand for:

Tab. 221 Voice mail menu

Key	Meaning
1	Plays the next voice message
2	Goes back to the beginning of the current voice message
3 ¹⁾	Deflect voice message and keep a copy
4 ¹⁾	Deflect voice message and delete it in your own mailbox
8	Erases the current voice message

¹⁾ followed by user number and #-key



Tips:

- You can skip the Audio Guide information using the #-key.
- The voice mail menu is also available when retrieving messages from the voice mailbox with your own phone (using function code *#94 or by calling the number of the voice mail system).

Reference to Other Features

Features:

- "Sending and reading text messages", page 416
- "Conversation recording", page 452
- "Organising absences on the workstation", page 359

9.6.2 Dialling by name

Instead of entering user B's phone number, user A can dial user B's name. The communication server supports "dialling by name" and "dialling with quickdial". Please refer to the Operating Instructions of the system phones for more details.

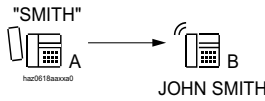

Fig. 201 Dialling by name

Interface	Scope
A	Requirement: The name must be stored in the caller's communication server: in the abbreviated dialling list, the phone book, the UG configuration or the user configuration.
B	Possible interfaces: <ul style="list-style-type: none"> • Users: internal, external, PISN • User group (UG)



Tip:

The name of a PISN user can be configured in a PINX user configuration, provided the user's number is entered in full (see "Numbering plan", page 43).

System configuration

Tab. 222 Dialling by name: System configuration

Parameter
User name, Abbreviated dialling name, PISN user name, User group name



Tip:

An external directory can also be connected to the communication system via OIP. To browse the directory, you need to initiate dialling by name with the 0 key or the *-key.

9.6.3 End-of-selection signal

The input of an external number can be completed with the character #. The communication server (or network system) interprets this as the end of selection and immediately switches through.

Detailed Description

Dialling with end-of-selection signal is important in several cases:

- when dialling an external number in an open numbering plan (Fig. 202).
- when the LCR (Least Cost Routing) function is activated: In this case the communication server has to wait until the user has entered all the digits before it can forward the complete number to the network provider configured. The end-of-selection signal does not require any additional waiting time (Fig. 203).
- With SIP terminals on a communication server and a communication server connected via an SIP provider to the public network. Without end-of-selection the waiting time is 4 seconds.

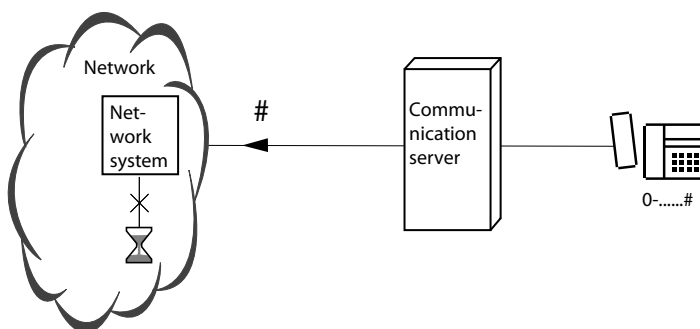

Fig. 202 Dialling with end-of-selection signal

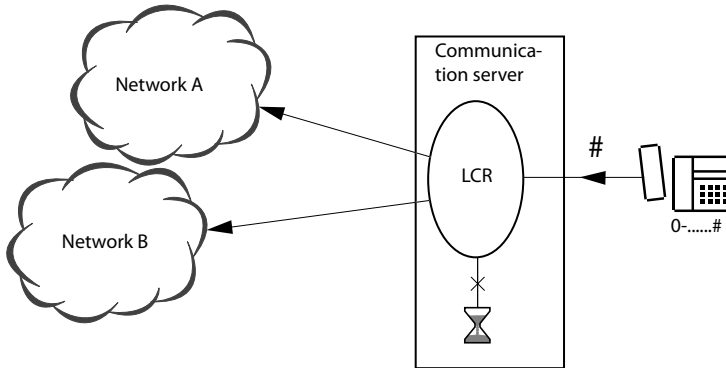

Fig. 203 Dialling with end-of-selection signal with the LCR function activated

Function in prefix dialling

Completing dialling with end-of-selection signal: External user No. #.

System configuration

Tab. 223 End-of-selection signal: System configuration

Parameter	Parameter value	Remarks
No settings		

9.6.4 Call waiting

Call waiting is used to notify an internal, busy user B that another user C is waiting to talk.

User B can choose to take C's call (and put the original call on hold, end the original call or set up a three-party conference) or reject it.

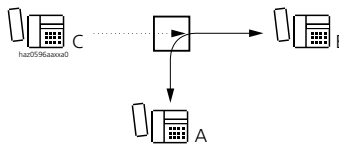

Fig. 204 Call waiting

Detailed Description

Tab. 224 Call waiting

Interface	Operating sequence / signalling on the terminal	Scope
B	B hears the dampened call waiting tone, which is played into the current call. If B has a terminal with display, the call number or name of caller C is indicated, provided his CLIP / CNIP information is available.	Requirement: <ul style="list-style-type: none"> • B has allowed call waiting on his set. • B is not in the process of setting up a call, in an enquiry call or in a conference.
C	<ul style="list-style-type: none"> • C obtains the ring-back tone by way of confirmation. • C obtains the busy tone if call waiting is not allowed or not available and if B rejects the call waiting. 	Possible interfaces: <ul style="list-style-type: none"> • internal¹⁾ Requirement: <ul style="list-style-type: none"> • C is authorized to use call waiting.

¹⁾ If C is an external user, call waiting is effected automatically (i.e. C cannot activate call waiting), providing the user receiving the call waiting has enabled the feature.

If B is in an outside call, call waiting will only work if this feature is enabled for outside calls, too (applies to the entire system).

If the announcement service is activated and user B does not respond to the external call waiting, the calling user C will obtain a greeting message.







Tip:



If call waiting is disabled, the Attendant for example has the possibility of sending a text message to users who have a system phone with display, and to do so even during a call (e.g. "Urgent international call").

Functions

Tab. 225 Call waiting: Suffix dialling functions

Functions	System phones	Analogue terminal
Activate call waiting	<ul style="list-style-type: none"> •  • *43 	R6 or R*43 (R = control key)
Answer without hold → End call and answer other call	<ul style="list-style-type: none"> •  • Use digit suffix dialling: 1 	R1
Answer with hold → Hold call and answer other call	<ul style="list-style-type: none"> •  • Use digit suffix dialling: 2 	R2
Answer with conference → Include other call in the current call	<ul style="list-style-type: none"> •  • Use digit suffix dialling: 3 	R3
Reject → Continue with original call	<ul style="list-style-type: none"> •  • Use digit suffix dialling: 0 	R0

Tab. 226 Functions in prefix dialling

Functions	Function codes	System phones
Protect own set against call waiting	*04	
Allow call waiting on own set	#04	

System configuration

Tab. 227 Call waiting: System configuration

Parameter	Parameter value	Remarks
Call waiting	Yes	User configuration
Protect against call waiting	Yes / No	User configuration
Call waiting / intrusion on exchange connection	Yes / No	Throughout the system

Reference to Other Features

Features:

- "intrusion", page 402
- "Hold (enquiry call)", page 365
- "Conference", page 371

9.6.5 intrusion

If the called internal user B is busy, the internal user C has the possibility of intruding into the current call. User C hears the current call and has the possibility of talking to user B into whose call C has intruded. User A is not normally aware of this.

User B can choose to take C's call (and put the original call on hold, end the original call, set up a three-party conference) or reject it.

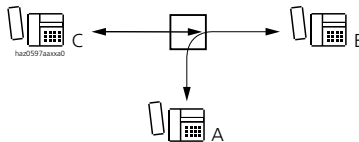

Fig. 205 Intrusion

Detailed Description

Tab. 228 Intrusion

Interface	Operating sequence / signalling on the terminal	Scope
A	If B is connected analogously and/or the handset volume on B is set to loud, A hears C's intrusion and may even be able to hear what C has to say to B.	
B	The intrusion tone and the system phone display signal user B that, in addition to the current call, he also has an internal call to intruded user C.	Requirement: <ul style="list-style-type: none"> • B has allowed intrusion on his set. • B is not in the process of setting up a call, in an enquiry call or in a conference.
C	C will obtain the busy tone if intrusion is not enabled or not available and if B rejects the intrusion.	Possible interfaces: <ul style="list-style-type: none"> • Internal Requirement: <ul style="list-style-type: none"> • C has the authorization to intrude.



Note:

If the conference tone is deactivated in the system configuration, user B will not hear an attention tone. The national terms and conditions for data protection need to be observed in this respect.

If B is making an exchange all, intrusion will only work if this feature is also enabled for exchange calls, throughout the system.





Tip:

If intrusion is disabled, it is possible to send a text message to an intruded user if he has a system phone with display, and to do so even during a call.

Functions

Tab. 229 Intrusion: Suffix dialling functions

Functions	System phones	Analogue terminal
Activate intrusion	<ul style="list-style-type: none"> • Use digit suffix dialling: 7 • *44 	R7 or *44 (R = control key)
Answer without hold → End call and answer other user	<ul style="list-style-type: none"> •  • Use digit suffix dialling: 1 	R1
Answer with hold → Hold call and answer other user	<ul style="list-style-type: none"> •  • Use digit suffix dialling: 2 	R2
Answer with conference → Include other user in the current call	<ul style="list-style-type: none"> •  • Use digit suffix dialling: 3 	R3
Reject → Continue with original call	<ul style="list-style-type: none"> •  • Use digit suffix dialling: 0 	R0

Tab. 230 Intrusion: Functions in prefix dialling

	Function codes
Protect own set against intrusion	*04
Allow intrusion on own set	#04

System configuration

Tab. 231 Intrusion: System configuration

Parameter	Parameter value	Remarks
<i>Intrusion</i>	Yes / No	User configuration
<i>Protect against intrusion</i>	Yes / No	User configuration
<i>Call waiting / intrusion on exchange connection</i>	Yes / No	Throughout the system
<i>Conference / intrusion / call waiting tone</i>	Repeated / Off / Once only	Throughout the system

Reference to Other Features

Features:

- "Silent intrusion", page 404
- "Call waiting", page 400
- "Hold (enquiry call)", page 365
- "Conference", page 371

9.6.6 Silent intrusion

Silent intrusion is a variant of the *Intrusion* feature and is used primarily in call centres.

If the called internal user B is busy, the calling internal user C has the possibility of intruding into the current call without call parties A and B being aware of it. Unlike with the *Intrusion* feature, user B is signaled neither visually nor acoustically and thus cannot reject *Silent intrusion*. User C listens to the ongoing call. His microphone remains switched off.

User C can now enable his microphone or press the *Intrusion* Foxkey at any time to intrude into the call.¹⁾ Normal *Intrusion* with signaling is then carried out as described in "*intrusion*", page 402.

¹⁾ Supported only for system phones of the Aastra 5300, Aastra 5300ip, Aastra 600d series and the Aastra 2380ip system softphone

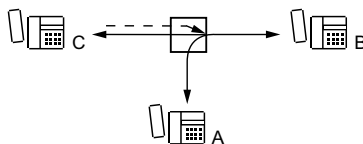

Fig. 206 Silent intrusion

Detailed Description

Tab. 232 Silent intrusion

Interface	Operating sequence / signalling on the terminal	Scope
A	In principle no signaling. Depending on the connection type, user A can hear a crackling when C intrudes (see Tab. 233).	
B	In principle no signaling. Depending on the connection type, user B can hear a crackling sound when C intrudes (see Tab. 233).	Requirement: <ul style="list-style-type: none"> • B has allowed intrusion on his set. • B is not in the process of setting up a call, in an enquiry call or in a conference.
C	C hears a busy tone if intrusion is not allowed or is not available	Possible interfaces: <ul style="list-style-type: none"> • Internal Requirements: <ul style="list-style-type: none"> • C has the authorization for silent intrusion. • A Silent Intrusion licence is in place.

If B is making an exchange all, *Silent intrusion* will only work if this feature is also enabled for exchange calls, throughout the system.



Notes:

- In connection with the *Silent intrusion* feature, relevant national data protection regulations must be observed.
- One *Silent intrusion* licence is required to be able to use the *Silent intrusion* feature.
- Silent intrusion is not possible in all cases and in certain cases may cause a crackling sound (see Tab. 233).
- Analogue terminals cannot switch directly from the *Silent intrusion* state to *Intrusion*. The microphone is always active with these terminals.

Connections overview

Silent intrusion is not possible in all cases and not absolutely silent. For IP-IP, IP-SIP and SIP-SIP connections, the media is switched directly and not via the system. In these cases the connection must first be fetched into the system for the intrusion, causing a faint crackling. Prerequisites for this procedure are sufficient VoIP licenses and DSP resources.

Tab. 233 Silent intrusion: Connections

Existing connection combination	Intruding terminal	
	DSI, DECT, IP, FXS	ISDN, SIP
External (ISDN, FXS) — internal (any)	Silent	Not possible
External SIP — internal (DSI, DECT, ISDN, FXS)	Silent	Not possible
External SIP — internal (IP, SIP)	Audible crackling	Not possible
Internal (IP, SIP) — internal (IP, SIP)	Audible crackling	Not possible
Internal (DSI, DECT, ISDN, FXS) — internal (DSI, ISDN, FXS, IP, SIP)	Silent	Not possible
Internal (DECT) — internal (DECT)	Not possible	Not possible
External (any) — external (any)	Not possible	Not possible

Functions

Tab. 234 Silent intrusion: Suffix dialling function

Function	System phones	Analogue terminal
Activate silent intrusion	Use digit suffix dialling: 4	R4 (R = control key)

Tab. 235 Silent intrusion: Function in prefix dialling

Function	System phones	Analogue terminal
Activate silent intrusion	With function key in prefix dialling (configurable only by system administrator via AMS)	–

System configuration

Tab. 236 Silent intrusion: System configuration

Parameter	Parameter value	Remarks
<i>Silent intrusion</i>	Yes / No	User configuration
<i>Silent intrusion protection</i>	Yes / No	User configuration
<i>Call waiting / intrusion on exchange connection</i>	Yes / No	Throughout the system

Reference to Other Features

Features:

- "intrusion", page 402
- "Call waiting", page 400
- "Hold (enquiry call)", page 365
- "Conference", page 371

9.6.7 Announcement to one or more users

The announcement feature allows user A to address user B (or an announcement group) directly via the loudspeaker on B's system phone, without waiting for his answer. User B has the possibility to answer the announcement (in which case the announcement is converted into a normal, internal connection) or to interrupt it (clear down the connection).

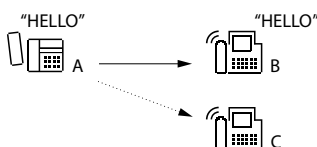

Fig. 207 Announcement

Detailed Description

Tab. 237 Announcement

Interface	Operating sequence / signalling on the terminal	Scope
A		Requirement: <ul style="list-style-type: none"> • A is authorized to make announcements
B	When announcement is activated, a warning tone is audible over the loudspeaker on all user B's system phones or on all the system phones of the users in the announcement group.	Possible interfaces: Internal only: <ul style="list-style-type: none"> • User • Group of users Requirement: The system phone supports announcement and B has allowed announcement to his own set

**Note:**

To protect the user's hearing, announcements to the Office 135 cordless system phone are possible only if the phone is in its charging bay. This restriction does not apply to the Office 160 cordless system phone as the loudspeaker is located on the upper side of the phone.

Creating announcement groups:

- Up to 8 (system 2065: 16) announcement groups can be defined.
- Each group can consist of up to 16 users.
- These announcement groups are also used for the feature Send text messages (see "[Sending and reading text messages](#)", page 416).

**Notes:**

- For each announcement group one announcement can be made to a maximum of 16 phones simultaneously. This limit is quickly reached if several phones are allocated to each user. The first 16 phones of the members of an announcement group are taken into account, starting with the lowest member number. Only the phones for which the announcement can be made actually count (e. g. a set can be protected against announcement).
- If the announcement is on an analogue phone, it calls with a special call pattern (200 ms ring – 200 ms pause – 200 ms ring – 200 ms pause etc.). The analogue Aastra 1910 and Aastra 1930 phones specially designed for retirement homes and hospitals are able to recognize this ringing pattern and switch automatically to hands-free mode.



Restriction: Analogue telephones in an announcement group are not permitted.

**Tip:**

This feature can be combined with the transfer of an outside call to a paged person. If the announcement is answered, the user searched for is automatically connected with the exchange user put on hold.

Functions in prefix dialling

Tab. 238 Announcement: Functions

Functions	Function codes	System phones
Setting up an announcement to a user or announcement group	*7998 <User No.> or *79 <Group No.>	<ul style="list-style-type: none"> •  • Office 35, Office 45, Aastra 5370, Aastra 5380: double-click team key of individual users
Answer announcement (called party)		answer
Answer announcement from a terminal outside the group	*89 (the other users in the announcement group are switched out)	
Reject announcement (called party)		 or Loudspeaker key
Protect own set against announcement / Allow announcement to own set	-	



Note:

Only one announcement to one group can be active at any one time. Answering with *89 is therefore unambiguous.

System configuration

Tab. 239 Announcement: System configuration

Parameter	Parameter value	Remarks
<i>Announcements</i>	Yes	User configuration
<i>Message and announcement group</i>	<User No.>	

Reference to Other Features

Features:

- "Intercom", page 412

9.6.8 Charge recall

By activating a charge recall, user B can transfer an exchange line to an internal user A. At the end of the exchange call, user B is called back with an indication of the call charges.

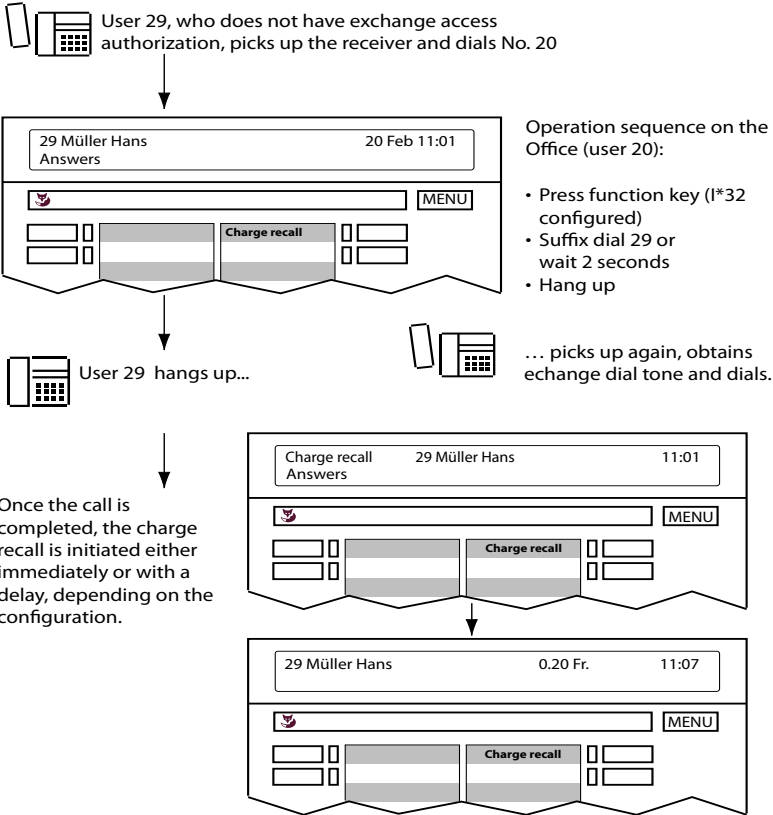

Fig. 208 Charge recall

Typical cases for charge recall are:

- Phone booth connection
- Exchange-barred users
- Printer jam during CL output

Detailed Description

User B: Charge recall can only be activated from digital system phones with a display.

User A: At the end of the call, the user's exchange access is automatically barred again.

Under Charge recall in the AMS Account Manager a time can be configured for both standard and phone booth connections by which a charge recall is delayed when the handset goes on-hook. This means that more than one exchange call can be made before the charge recall is effected. If the configured time is greater than zero, the internal user automatically obtains the exchange-free signal when he picks up the handset again and is able to dial a new number directly. If the user does not pick up the handset within the time delay, a charge recall is effected.



Tip:

Store charge recall (*32 phone booth No.) under a function key.

Function in prefix dialling

Tab. 240 Charge recall: Function

Function	Function code
Activate charge recall to standard connection	*32 User No.

System configuration

Tab. 241 Charge recall: System configuration

Parameter	Parameter value	Remarks
<i>Charge recall: Standard</i>	0 to 120 seconds	
<i>Charge recall: Phone booth</i>	0 to 120 seconds	

Reference to Other Features

Features:

- "Phone booth", page 508

9.6.9 Intercom

Duplex mode is a special of announcement whereby the called system phone B immediately transform A's announcement into an internal call.

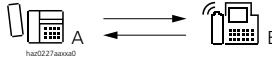

Fig. 209 Duplex mode

Detailed Description

Tab. 242 Duplex mode

Interface	Operating sequence / signalling on the terminal	Scope
A	Activates announcement	Requirement: • A is authorized to make announcements
B	The announcement is signalled by a warning tone (3 short signal tones). The call connection is then switched through (loudspeaker and microphone active).	Possible interfaces: Internal only: • User Requirement: • The system phone supports the automatic announcement facility (Office 35, Office 45, Aastra 5370, Aastra 5380) • Automatic announcement is activated on the system phone.

In duplex mode the connection setup is the same as for an ordinary announcement made to a user.

Function in prefix dialling

Tab. 243 Duplex mode: Functions

Function	Function code	System phones
Set up announcement or duplex mode (calling party)	*7998 User No.	<ul style="list-style-type: none"> •  • Office 35, Office 45, Aastra 5370, Aastra 5380: double-click team key
Setting on the destination phone		Automatic hands-free facility on <i>Announcement</i> or <i>On</i>



Note:

The automatic hands-free talking setting on a system phone can be either disabled, enabled (all internal incoming calls incl. announcements are automatically seized) or enabled for announcement only.

System configuration

Tab. 244 Duplex mode: System configuration

Parameter	Parameter value	Remarks
<i>Announcements</i>	Yes	User configuration
<i>Message and announcement group</i>	<User No.>	

Reference to Other Features

Features:

- ["Announcement to one or more users", page 407](#)

9.6.10 Picking up a call

An incoming call from user A to user B can be fetched from any terminal C and then answered.

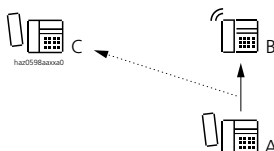

Fig. 210 Call pick-up

Detailed Description

Tab. 245 Picking up a call

Interface	Operating sequence / signalling on the terminal	Scope
A-B		Incoming call to be fetched: <ul style="list-style-type: none"> • To a user • On a user group (UG) • Excluded: Call to line key, appointment reminder call, recall
B		Possible interfaces: internal only



Tip:

Users who are not at their desk can take their calls from another terminal. Calls from persons who have not configured CFU can be fetched and answered.

Function in prefix dialling

Tab. 246 Picking up a call: Function

Function	Function code	System phones
Call pick-up	*86 <User No.> or *86 <UG No.> for any user called in the UG at that particular moment.	<ul style="list-style-type: none"> ☎ Office 35, Office 45, Aastra 5370, Aastra 5380: click the Team key

System configuration

Tab. 247 Picking up a call: System configuration

Parameter	Parameter value	Remarks
No settings		

Reference to Other Features

Features:

- "Fast take (pick up a call or a call connection)", page 445

9.6.11 Hotline

User A can be allocated one of 20 different hotline destinations. Whenever the handset of a terminal assigned to user A is picked up, the configured hotline destination number D will automatically be dialed once the set delay has expired.

One hotline destination and a delay time can also be configured for each terminal. The configuration on the terminal takes precedence over the user configuration. If hotline destination E is also configured on terminal C, the destination is called regardless of the configured delay times.

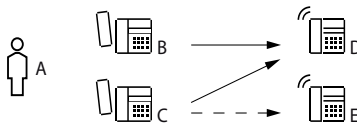

Fig. 211 Automatic dialling with hotline

Detailed Description

Tab. 248 Hotlines

Interface	Scope
D, E	Possible interfaces: internal, external, PISN

Once the hotline destination number has been dialled, other digits can be suffix dialled (for example, for a fax terminal the network access prefix is entered as the hotline destination).

If the user is not connected with the hotline destination, he has the following options:

- Press the Disconnect key. This stops the timer with the configured delay or, once it has expired, the ringing at the hotline destination is interrupted and the user has the possibility of dialling a different call number.
- Dial a new call number before the configured delay expires. The timer is restarted every time a number key is pressed, which means that the entire dialling sequence does not have to be made within the configured delay. The timer is stopped as soon as dialling is completed and a call connection has been set up.

Typical applications:

- Lift telephone
- Emergency telephone
- Door phone (entrance gates)
- Phone booth connection
- Fax

Additional applications:

- Temporary hotline for hotel room and phone booth phones
- Baby alarm on hotel room phone
- Hotline to network in conference rooms
- Hotline to reception in unoccupied hotel rooms
- Hotline from rooms with sick or handicapped guests (homes, hospitals, etc.)
- Hotline with Fast Take on GAP DECT headset (*88 <own user number>).

Function in prefix dialling

Activate hotline: Pick up handset or press Loudspeaker key.

System configuration

Tab. 249 Hotline: System configuration

Parameter	Parameter value	Remarks
<i>Hotline</i>	<1..20>	User configuration
Destination configuration:		
<i>Call number</i>	<Call number> for hotline 1..20	Restriction: With analogue and ISDN terminals the maximum delay is limited by the dialling timeout (approx. 12 s, depending on the sales channel).
<i>Delay</i>	<0..60> seconds for hotline 1..20	
Terminal configuration:		
<i>Hotline call number</i>	<Call number>	Restriction: With analogue and ISDN terminals the maximum delay is limited by the dialling timeout (approx. 12 s, depending on the sales channel).
<i>Hotline delay</i>	<0..60> seconds	

9. 6. 12 Sending and reading text messages

This feature provides a means of sending a text message within the system. Potential destinations include:

- One internal user
- One message group
- All internal users

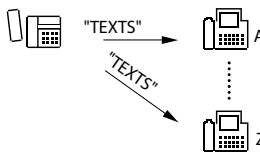

Fig. 212 Sending and reading text messages

Detailed Description

Tab. 250 Sending and reading text messages

Interface	Operating sequence / signalling on the terminal	Scope
B	When a text message is received, the destination users obtain an attention ringing tone.	Possible destinations (internal only): <ul style="list-style-type: none"> • User • Message group (user groups are not permitted) • All internal users Requirement: Destination users are equipped with a system phone with alphanumerical display.

Message groups for text messages:

- Up to 8 (system 2065: 16) groups can be defined.
- Each group can consist of up to 16 users.
- These message groups are also used for the Announcement feature (see "[Announcement to one or more users](#)", page 407).

The text of a text message is either user-definable or can be selected from 16 texts (standard texts) predefined by the system (see "[Standard texts](#)", page 421). In addition 5 personal message texts can also be stored on the Office 45.

A message text can be up to 160 characters long.

Standard texts can be activated with or without additional text (parameters).

In principle callback requests and notifications by the voice mail system are displayed with a higher priority on the system phone, i.e. before any text messages.

A maximum of 16 text messages are stored for any given destination user.







Tip:

A busy user who is also protected against intrusion and call waiting can still be reached using text messages.

Functions in prefix dialling

Tab. 251 Sending and reading text messages: Functions

Functions	Function codes	System phones
Send standard text with / without parameters to user	*3598 <User No.> <Text No.> [Param] #	
Send standard text with / without parameters to group	*35 <Gr. No.> <Text No.> [Param] #	
Send standard text with / without parameters to all	*3599 text No. [Param] #	
View text messages		

System configuration

Tab. 252 Text messages: System configuration

Parameter / action	Parameter value	Remarks
<i>Text messages</i>	<Message text> for message 1...16	Texts can be edited
<i>Message and announcement group</i>	Member <user No.> for group 1...8 (16)	
Reset to initialization standard texts	<Language>	Individual standard texts cannot be reset.
Delete all pending messages		Deletes the messages on all system phones
Delete messages more than 3 days old		Deletes the messages on all system phones

Reference to Other Features

Features:

- "Leave message", page 420
- "Standard texts", page 421
- "Voice mail system", page 382
- "Message and Alarm Systems", page 511

9. 6. 13 Message function

A MESSAGE can be sent from any terminal to all system phones. Depending on the terminal the receipt of a MESSAGE is signalled by a callback request.



Fig. 213 Activate MESSAGE

Detailed Description

Tab. 253 Activate MESSAGE

Interface	Operating sequence / signalling on the terminal	Scope
A	Once the callback function has been executed, A obtains the acknowledgement tone.	Requirement: The activating user A must be authorized to use this function.
B	<ul style="list-style-type: none"> System phones with display: Text messages, attention tone, LED display Office 10: LED display only 	Possible interfaces: Internal Requirement: System phone

Number of callback requests:

The number of callback requests that can be stored depends on the system phone type.

Display priority:

External alarm messages have maximum priority. Callback requests are displayed with a higher priority than voice mail notifications and text messages.



Tip:

With the MESSAGE function a user has the possibility of activating several callbacks simultaneously, depending on his system phone.

Functions in prefix dialling

Tab. 254 Activating MESSAGE: Functions

Functions	Function codes
Activate MESSAGE	*38 User No.
Answer MESSAGE (trigger callback)	*#38
Clear MESSAGE on the destination phone	#38#
Clear MESSAGE on the executing phone	#38 User No.

System configuration

Tab. 255 MESSAGE: System configuration

Parameter	Parameter value	Remarks
MESSAGE (*38)	Yes	User configuration

Reference to Other Features

Features:

- "Callback if user busy / free", page 427
- "Wait until free", page 431

9.6.14 Leave message

If user B is absent or unobtainable for longer period of time, he can leave a message in the system for internal users. If user A now calls user B from a system phone with display, the system will send to A's display the text left by B.

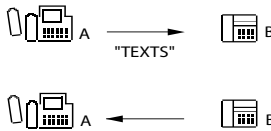

Fig. 214 Leave message

Detailed Description

Tab. 256 Leave message

Interface	Operating sequence / signalling on the terminal	Scope
A		Possible interfaces: internal only Requirement: The user is equipped with a system phone with alphanumerical display.
B	The user obtains the acknowledgement tone every time he activates / deactivates the feature.	

If the conditions for user A are not met (A is not an internal user or does not have an alphanumerical display):

The call is routed to the number of the preconfigured Call Forwarding Unconditional. If this number is not configured, the call is routed in the normal way to the user who left the message. The call is stored in the list of callers.

Message:

- The message is either user definable or can be selected from a choice of 16 standard texts (see "[Standard texts](#)", page 421).

- The standard texts can be configured to the customer's special requirements.
- The standard texts can be activated with or without additional parameters. Their length is limited to 160 characters.

**Note:**

Activating a call forwarding deletes the message.

Functions in prefix dialling

Tab. 257 Leaving a message: Functions

Functions	Function codes
Activate leave message	*24 Text. No. [Param] #
Clear leave message	#24

System configuration

Tab. 258 Leaving a message: System configuration

Parameter	Parameter value	Remarks
<i>Preconfigured CFU</i>	<User No.>	

Reference to Other Features

Features:

- "Call Forwarding Unconditional (CFU)", page 339
- "Sending and reading text messages", page 416

9.6.15 Standard texts

Tab. 259 Message texts predefined in the system

Number	Text
1	MEETING AT >
2	PLEASE CALL BACK >
3	FOLLOWING MEETING HAS BEEN CANCELLED >
4	REQUIRED INFORMATION ON >
5	URGENT DELIVERY >
6	PLEASE DROP BY IMMEDIATELY >
7	PLEASE COLLECT MAIL >
8	MAIL WAITING >
9	I'M IN THE WAREHOUSE >
10	I'M IN THE OFFICE >

Number	Text
11	I'LL BE BACK ON >
12	I'M AWAY UNTIL >
13	I'M AWAY. MY REPLACEMENT IS >
14	I'M AWAY BRIEFLY >
15	PLEASE DO NOT DISTURB >
16	I CAN BE REACHED UNDER NO. >

Standard texts can be complemented or reworded before they are sent. The changes are not stored.

With AMS the language for the standard texts can be selected independently of the language setting on the system phones.

With AMS the standard texts can be adapted to suit requirements but also reset to the original text as defined by the initialization values.

If the Call Centre is connected, text message No. 8 must not be reconfigured.



Aastra Intelligent Net:

In an AIN with nodes in different language regions it makes sense to specify a common language (e.g. English) for the standard texts. Alternatively you can reduce the number of standard texts and then provide them in two or several languages (e.g. standard texts 1...8 = English and 9...16 = French).

System configuration

Tab. 260 Standard texts: System configuration

Parameter / action	Parameter value	Remarks
Text message	<Message text> for message 1...16	Texts can be edited
Reset to initialization standard texts	<Language>	Individual standard texts cannot be reset.

Reference to Other Features

Features:

- "Sending and reading text messages", page 416
- "Leave message", page 420

9.6.16 Park

9.6.16.1 Local call parking

A user B has put his call with on hold to answer C's call waiting signal. To transfer C to a user D, B must first park his call with A so that he can put C on hold and set up the enquiry call connection to D. Once he has transferred the call, B can retrieve the parked call and continue his call.

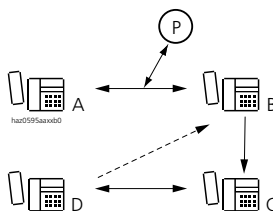

Fig. 215 Local call parking

Detailed Description

Tab. 261 Local call parking

Interface	Operating sequence / signalling on the terminal	Scope
A	Once the function has been executed, the user obtains an acknowledgement tone.	Requirement: The user has a system phone. Restriction: A maximum of one call can be parked locally on each phone.
B	The parked user will obtain the signalling for <i>Music on hold</i> .	

If the parked call is not retrieved within the preset parking time¹⁾, user A will receive a recall.

Some phones allow configuring a separate parking key (see "[Configurable keys](#)", page 333).

The Astra 1560 / Office 1560 operator console also allows locally parked calls from other users to be retrieved.

The parked call is signalled on all the assigned system phones of user B and can be retrieved from any of these phones.

¹⁾ The parking time varies from country to country

Functions

Tab. 262 Local parking: Suffix dialling function

Function	System phones
Park call locally	

Tab. 263 Local parking: Function in prefix dialling

Function	System phones
Retrieve call	

System configuration

Tab. 264 Local parking: System configuration

Parameter	Parameter value	Remarks
No settings		

Reference to Other Features

Features:

- "Configurable keys", page 333
- "Park", page 423
- "Hold (enquiry call)", page 365

9. 6. 16. 2 Central call parking

User A wants to continue a call with user B on a terminal belonging to user C. He can park the call on the communication system's central call parking space and then retrieve the call from one of user C's terminals.

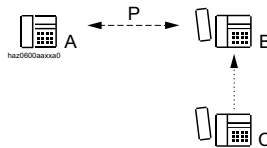

Fig. 216 Parking and retrieving a call centrally

Detailed Description

Tab. 265 Central call parking

Interface	Operating sequence / signalling on the terminal	Scope
A	Once the function has been executed, the user obtains the acknowledgement tone.	Restriction: Only 1 call can be parked centrally throughout the system at any given time.
B	The parked user will obtain the signalling for <i>Music on hold</i> .	Possible interfaces: Random
C		Possible interfaces: Internal

If the parked call is not retrieved within the preset parking time¹⁾, user A will receive a recall.

Suffix dialling functions

Tab. 266 Central call parking: Functions

Functions	Function codes
Park call centrally	*76
Retrieve call	#76

System configuration

Tab. 267 Central parking: System configuration

Parameter	Parameter value	Remarks
<i>Music on hold</i>	<i>No music / External audio source / Internal audio source / Hold tone</i>	Throughout the system

Reference to Other Features

Features:

- "Local call parking", page 423
- "Hold (enquiry call)", page 365

¹⁾ The parking time varies from country to country

9. 6. 16. 3 Call parking function of the key telephone

A call signalled on a line key can be parked on the line key:

- The call is parked automatically if another call arrives on another line key and is answered.
- The call can also be explicitly parked by the user.

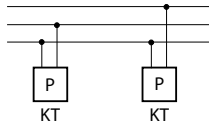

Fig. 217 Parking on a line key (key telephone)

Detailed Description

On a through line the call is signalled as parked on the other key telephones and can therefore also be retrieved and continued on those terminals.

Whether or not the parking time is monitored by the communication server varies from country to country.

Several calls can be parked simultaneously on different line keys.

Suffix dialling functions

Tab. 268 Call parking function of the key telephone: Functions

Functions	Key Telephones
Park call on line key (explicit)	<ul style="list-style-type: none"> • Using the park key • Initiate enquiry call and hang up
Park call on line key 1 when receiving call on line key 2 (automatic)	Press line key 2 on which the other call is signalled
Retrieve call	Press line key again

9. 6. 16. 4 Call parking function on the operator console

Attendant B is talking to user A when another call from user C arrives in the call queue. The active call is not to be transferred just yet and the attendant answers the incoming call. The original call is automatically parked on the corresponding line key (Office 45) or in the call queue (Aastra 1560 / Office 1560).

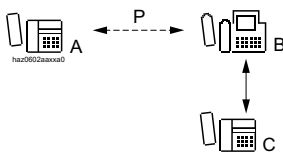

Fig. 218 Call parking function on the operator console

Detailed Description

Whether or not the parking time is monitored by the communication server varies from country to country.

The number of calls parked simultaneously using this call parking function is limited only by the display capabilities of the terminal in question.

On the Office 45 a call can also be parked explicitly on the line key.

Suffix dialling functions

Tab. 269 Call parking function on the operator console: Functions

Functions	Office 45 operator phone, Aastra 1560 / Office 1560 operator console
Park call with the OC parking function	Answer other call in the call queue
Park call explicitly on the line key (Office 45)	Press hold key and then clear key
Retrieve call	Activate signalling element (Office 45: Line key) once again

9. 6. 17 Callback if user busy / free

This feature is used to obtain an automatic callback if a user is busy or if a call to a user who is signalled as free goes unanswered.

9. 6. 17. 1 Callback if user busy

User A has the possibility of activating a callback to busy user B (callback request). As soon as the busy user B becomes free, user A will be called back within 10 s. As soon as A picks up the phone, the system automatically calls user B, who is now free.

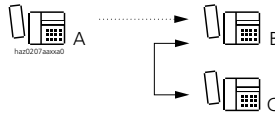

Fig. 219 Callback if user busy

Detailed Description

Tab. 270 Callback if user busy

Interface	Operating sequence / signalling on the terminal	Scope
A	Once the function has been executed, A obtains the acknowledgement tone.	Restriction: User A can only initiate one callback at a time.
B		Possible interfaces: internal, external ¹⁾ , PISN ²⁾ Restriction: Only one callback at a time can be loaded onto an external user or a PISN user.

¹⁾ Callback to the busy external user is possible only if the public network supports the service "Completion of Calls to Busy Subscriber" (CCBS) end-to-end.

²⁾ If the PISN user is reached via the public network, the conditions of the public network for callback when busy will apply.

The callback is triggered only to user A, who set the callback, regardless of whether a CFU or CFNR to a user C has been activated at A.

Amount of time a callback if busy remains valid:

- B is internal: 45 min
- B is external: 30 min
- B is in the PISN: can vary in a heterogeneous PISN (system: 45 minutes)

Callback to a busy external user B:

If user B is a communication server user, he must have his own direct dial number and his communication server must also support the feature. There are three possible DDI variants:



DDI number → user B

DDI number → user B + UG

DDI number → user B + KT

Suffix dialling functions

Tab. 271 Callback if user busy: Functions

Functions	System phones	Analogue terminal
Activate callback		R9 or R*37
Clear callback		#37



Note:

Completion of calls to busy is provided on the system phone even if it is not available. *Not available* is signalled after activation.

System configuration

Tab. 272 Callback if user busy: System configuration

Parameter	Parameter value	Remarks
No settings		

Reference to Other Features

Features:

- "Callback to free user", page 429
- "Wait until free", page 431
- "Message function", page 418

9.6.17.2 Callback to free user

User A can activate a callback to user B if B does not answer A's call. Since user B is making another call (gone off-hook and then back on-hook again), user A is called within 10 s. As soon as A picks up the phone, the system automatically calls user B.



Fig. 220 Callback to free user

Detailed Description

Tab. 273 Callback to free user

Interface	Operating sequence / signalling on the terminal	Scope
A	Once the function has been executed, A obtains the acknowledgement tone.	Restriction: User A can only initiate one callback at a time.
B		Possible interfaces: Internal



The callback is triggered only to user A, who set the callback, regardless of whether a CFU or CFNR to a user C has been activated at A.

Amount of time a callback to free user remains valid: 45 minutes.

If B has a system phone with display, a text message with a callback prompt will appear, i. e. the callback is not automatically initiated by the communication server. In principle callback requests are displayed with maximum priority on the system phone, i. e. before notifications by the voice mail system and before any text messages.

Suffix dialling functions

Tab. 274 Callback to free user: Functions

Functions	System phones	Analogue terminal
Activate callback		R9 or R*37
Clear callback		#37

System configuration

Tab. 275 Callback if user is free: System configuration

Parameter	Parameter value	Remarks
No settings		

Reference to Other Features

Features:

- "Callback if user busy", page 427
- "Wait until free", page 431
- "Message function", page 418

9.6.17.3 Wait until free

The Wait-until-free feature is a Callback-if-busy feature without the user who initiates the call having to hang up. He stays on the phone and waits until the busy user becomes free. The callback is triggered as soon as the called user has been free for 5 seconds. The connection is then set up automatically.

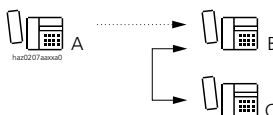

Fig. 221 Wait until free

Detailed Description

Tab. 276 Wait until free

Interface	Operating sequence / signalling on the terminal	Scope
A	<ul style="list-style-type: none"> Once the callback function has been executed, A obtains the acknowledgement tone. As soon as user B is free, A obtains the ring-back tone. 	Possible interfaces: internal, external ¹⁾
B		



¹⁾ Callback to the busy external user is possible only if the public network supports the service "Completion of Calls to Busy Subscriber" (CCBS) end-to-end.

User A must carry out the function with the handset off-hook and not via the loud-speaker key.

"Wait until free" works only with cordless phones.

Suffix dialling functions

Tab. 277 Wait until free: Functions

Functions	System phones	Analogue terminal
Activate callback		R9 or R*37
Clear callback		#37

System configuration

Tab. 278 Wait until free: System configuration

Parameter	Parameter value	Remarks
No settings		

Reference to Other Features

Features:

- "Callback if user busy / free", page 427
- "Message function", page 418

9.6.18 Team functions

The team functions make it easier for members of a team (for example a sales or marketing team) to communicate with one another and stand in for one another where required.

Team keys can be set up either on the system phones themselves or via AMS.

One team key is configured for each team member and allows the following functions and signalling states:

- Calling a team member using a simple keypress
- Signalling an incoming call for the team member and pick up the call using a simple keypress
- Signalling an existing connection to the team member
- And, depending on the system phone, other telephony functions (e.g. setting up an announcement to the team member)

Team keys and Twin Mode/Twin Comfort:

If a team key on a system phone is configured to a user with Twin Mode/Twin Comfort activated, the cordless phone call number is also stored automatically on the team key. This allows calls to be displayed and answered which were either forwarded to the team member's cordless phone by Twin Mode/Twin Comfort or were made directly to the cordless phone's number.

**Note:**

Team keys already configured on users who only subsequently activated Twin Mode/Twin Comfort are not automatically complemented with the cordless phone call number. However the AMS Configuration Manager can be used to enter the call number manually, something which is not possible on the corded system phone itself.

Scope

System phones that support the Team key: Office 35, Office 45, Aastra 5361, Aastra 5370, Aastra 5380, Aastra 1560 / Office 1560, Aastra 2380ip

System configuration**Tab. 279 Team function: System configuration**

Parameter	Parameter value	Remarks
No settings		

Reference to Other Features**Features:**

- "Configurable keys", page 333

9.6.19 Locking and unlocking terminals

Terminals are locked to prevent misuse or to force the allocation of call charges on a user-pays basis.

Terminals on the system can be locked and unlocked in different ways:

- Locking / unlocking the terminal (phone lock):
The user can lock one of his terminals or restrict the dialling possibilities using his PIN. As the PIN is assigned to the user, all his terminals have the same PIN. He uses the PIN to unlock the terminal once again.
- Lock and unlock all the terminals of a particular user:
The user can lock all his terminals or restrict the dialling possibilities using his PIN. He uses the PIN to unlock the terminals once again.
- Unlocking the terminal for each call:
Restricting the dialling possibilities at a user's terminals is configured in the system configuration.
With his PIN a user can lift the restriction and make one outgoing call. The termi-

nal is locked again automatically after the call. Permanent unlocking is not possible.

Internal and external digit barring is used for restricting dialling. This means the user is free to define what is restricted and by how much.

A terminal can be set up for one of these variants.

The PIN is the same for both variants.

All terminal types can be locked; on system phones with display the function is menu-supported.

9.6.19.1 Locking / unlocking terminals (telephone lock)

The phone lock inhibits or restricts the following operating possibilities:



- Dialling possibilities for internal and external calls, by activating internal and external digit barring.
- Operation of terminal settings.

The dialling restriction can be lifted by entering a PIN:

- The PIN is valid for all a user's terminals.
- Default PIN: "0000"
- Make sure you change the PIN the first time the feature is activated
- PIN syntax (all terminals): 2 to 10 digits, digits 0 to 9

Functions

Tab. 280 Phone lock: Functions

Functions	Function codes	System phones
Lock terminal (activate phone lock)	*33 <PIN> #	Office 45: • With the code key System phones with display: • 
Unlock terminal (deactivate phone lock)	#33 <PIN> #	
Lock all user's terminals	#33 * <PIN> #	#33 * <PIN> #
Unlock all user's terminals	#33 * <PIN> #	#33 * <PIN> #
Change PIN	*47 <old PIN> * <new PIN> * <new PIN> # ¹⁾	System phones with display:  (*47 also works)

¹⁾ For reasons of data protection no entry is made in the redial register.

The "Change PIN" feature can be remote-controlled, which means it can also be used for virtual users (see ["Remote control features"](#), page 487).

System configuration

Tab. 281 Phone lock: System configuration in AMS

Parameter	Parameter value	Remarks
<i>Change PIN</i>	<i>Yes / No</i>	Setting per user in the user authorization
Internal digit barring settings for the unlocked state	Enable *33 and #33	Allow phone lock locking variant
<i>Internal Digit Barring, phone lock</i>	Internal digit barring 1 to 8	Definition of internal dialling possibilities in the locked state
<i>External Digit Barring, phone lock</i>	External digit barring 1 to 8	Definition of external dialling possibilities in the locked state

Tab. 282 Resetting the PIN with AMS or Office 45

Parameter	Parameter value	Remarks
<i>Phone lock</i>	<i>Off / Configuration lock</i>	Change phone lock status without PIN
<i>PIN</i>	0000	Resetting the PIN

9.6.19.2 Unlocking the terminal for each call

Unlocking the terminal for each call allows the authorized user to enable any locked terminal system so that he can make a single outgoing call. After function code #36, the user dials his own internal user number and his personal PIN. This activates his digit barring settings and the call charges are charged to his charge counter: The called party sees the caller's user number and not the number of the user whose terminal is being used by the caller.

In this way an authorized user can use even unlocked terminals with his own settings.

For reasons of data protection no entry is made in the redial register.



See also:

["Making calls with your own settings on a third-party phone"](#), page 438

Unlocking a third-party terminal

An authorized user unlocks someone else's terminal. After unlocking it, he can either dial directly within the next 12 seconds or hang up and a number within 60 seconds.

The following remain locked and inaccessible:

- Operation of terminal settings
- Using the private phone book of the terminal's user
- Dialling by name

Typical application: Unlocking non-personal terminals in publicly accessible premises (meeting rooms, entrance lobbies, coffee-break areas).



Tip:

Configure a key with the unlock function.

Unlocking your own terminal

An authorized user unlocks his own terminal. After unlocking it he can either dial directly within the next 12 seconds or hang up and dial within 60 seconds with or without dialling by name. Both the terminal settings and the private phone book are available during those 60 seconds.

Authorized Users

For a user to be able to operate the "Unlock terminal for each call" feature, he must be known to the system as an internal user and have his own personal PIN. He defines the PIN on one of his allocated terminals:

- PIN syntax (all terminals): 2 to 10 digits, digits 0 to 9
- PIN validity
 - The PIN is valid for unlocking all terminals that were locked with this phone lock variant.
 - The default PIN "0000" cannot be used to unlock a terminal that was locked with this phone lock variant.

The PIN is stored on the system in the user configuration, where it can also be altered.

Functions

Tab. 283 Unlocking the terminal for each call: Functions

Functions	Function codes	System phones
Unlocking a third-party for each call	#36 <User No.> <PIN>	System phones: <ul style="list-style-type: none"> The function can be configured onto a key
Unlocking one's own terminal for each call	#36 <User No.> <PIN>	System phones: <ul style="list-style-type: none"> The function can be configured onto a key

System configuration

Tab. 284 Unlocking the terminal for each call: System configuration

Parameter	Parameter value	Remarks
User configuration of the terminal to be locked: <ul style="list-style-type: none"> <i>Phone lock</i>¹⁾ <i>Internal Digit Barring, phone lock</i> <i>External Digit Barring, phone lock</i> 	On Internal digit barring 1 to 8 External digit barring 1 to 8	Activates the lock Definition of internal dialling possibilities in the locked state Definition of external dialling possibilities in the locked state
<ul style="list-style-type: none"> <i>Internal digit barring: Input for the locked state</i> 	<ul style="list-style-type: none"> #36 enable #33 bar 	<ul style="list-style-type: none"> Allows unlocking for each call Prevents permanent unlocking. Important: Without this input the lock can be lifted at any time by the user.
<ul style="list-style-type: none"> <i>External digit barring</i> 	<Barring/enabling sequences>	Restriction of external outgoing dialling options
User configuration of the unlocking user: <ul style="list-style-type: none"> <i>PIN</i>¹⁾ 	<PIN>	<ul style="list-style-type: none"> Changes the PIN (must not be "0000"). PIN syntax (all terminals): 2 to 10 digits, digits 0 to 9

¹⁾ Setting also possible with Office 45

Reference to Other Features

Features:

- "Making calls with your own settings on a third-party phone", page 438
- "Private calls with PIN", page 439

9.6.20 Making calls with your own settings on a third-party phone

This feature allows the authorized internal user to use a third-party terminal with his own valid PIN to make a single call with the following personal settings:

- Internal and external digit barring settings
- Charge counters
- CLIP display

Detailed Description

After function code #36, the user dials his own internal user number and his personal PIN. This activates his digit barring settings and the call charges are charged to his charge counter: The called party sees the caller's user number and not the number of the terminal being used by the caller.

For reasons of data protection no entry is made in the redial register.

This same function is also used to unlock locked terminals to make a single call. For more details on this feature and how to set the PIN, see "[Unlocking the terminal for each call](#)", page 435.

Once the function has been activated, the user has the possibility to redial within 12 seconds without going on-hook; alternatively he can go on-hook and then dial within 60 seconds using prefix dialling.

In both cases operation is subject to the following restrictions:

- The terminal settings cannot be altered.
- The private phone book of the terminal's user cannot be used.
- Dialling by name is not possible.

Once the call is completed, the terminal returns to its normal mode, i.e. the terminal's digit barring settings are reactivated.



Tip:

The function can also be used to listen to one's own voice mailbox from someone else's terminal or to carry out user-related functions using */# function codes (e. g. to redirect one's own terminal).

Functions and system configuration

See "[Unlocking the terminal for each call](#)", page 435.

Reference to Other Features

Features:

- "Unlocking the terminal for each call", page 435
- "Private calls with PIN", page 439

9.6.21 Private calls with PIN

This feature is used to charge private phone calls automatically to private charge counters, using the appropriate System Configuration. Users must always enter their valid PIN beforehand. They can do so both on one of their own terminals and on a third-party terminal on the same communication server or within a PISN.

Detailed Description

The user dials the function code #46, keys in his user number and enters his personal PIN. This deactivates his external digit barring; the terminal is also unlocked, and the user obtains the exchange dial tone. He can then make an external call, which is automatically charged to his private charge counter.



Note:

To prevent unauthorized persons from making private calls at other user's expense, all private phone calls must be made with a PIN, even when users are using their own terminals. The procedure is the same for both locked and unlocked terminals.

Function in prefix dialling

Tab. 285 Private calls with PIN: Function

Function	Function code
Private call with PIN from one of one's own terminals or from a third-party terminal	#46 <User No.> <PIN> <external call number>

Other properties:

- During a call the function can also be made from an enquiry call.
- The called party sees the caller's user number and not the number of the user whose terminal is being used by the caller.
- For reasons of data protection no entry is made in the redial register.

- Unlike with #36 (making calls with your own settings but on a third-party phone) you cannot hang up after activating the function and then prefix dial within 60 seconds.
- The same PINs are used as for the phone lock.
- Users without their own terminals can be defined as virtual users, and can then also use this feature.

System Configuration requirements:

- For this feature to be used, the default PIN must be changed first (see "[Locking / unlocking terminals \(telephone lock\)](#)", page 434 for the syntax).
- A private exchange access must not be defined or the private exchange access prefix must be barred for all users using internal digit barring.



Note:

#46 temporarily bypasses any exchange access barring and the external digit barring of the user identified by means of his user number and PIN.

Reference to Other Features

Features:

- "[Making calls with your own settings on a third-party phone](#)", page 438
- "[Unlocking the terminal for each call](#)", page 435

9.6.22 Appointment reminder call

Each user can configure one individual appointment reminder call and one permanent appointment reminder call, which are then stored in the system.



Fig. 222 Appointment call

Detailed Description

Tab. 286 Appointment call

Interface	Operating sequence / signalling on the terminal
A	<ul style="list-style-type: none">• Once the function has been executed, A obtains the acknowledgement tone.• If the wake-up time is reached, the terminal will ring for 1 minute.

Individual call orders are executed only once over the next 24 hours.

The appointment reminder call is not forwarded if CFU, CFNR or Do not disturb is activated.

Permanent call orders are executed daily (Saturdays and Sundays included). The call order is activated from one of the corresponding user's terminals. If a user busy, the appointment call is carried out once he has completed his call.

The "Clear configurations" feature (*00 or #00) does not cancel appointment reminder calls.

Functions in prefix dialling

Tab. 287 Appointment call: Functions

Functions	Function codes
Activate individual call order	*55 hh mm (hh = hour 00...23; mm = minute 00...59)
Activate permanent call order	*56 hh mm (hh = hour 00...23; mm = minute 00...59)
Clear individual call order	#55
Clear permanent call order	#56

System configuration

Tab. 288 Appointment call: System configuration

Parameter	Parameter value	Remarks
No settings		



Aastra Intelligent Net:

In an AIN with different time zones the execution of an appointment reminder call is always determined by the time zone of the user for whom the appointment reminder call was activated. This has to be taken into account in particular when activating an appointment reminder call for a different user using remote control.

9. 6. 23 Acceptance of a call or data connection:

9. 6. 23. 1 Preliminaries

User D can enable user C to take over an existing call or data connection A-B.

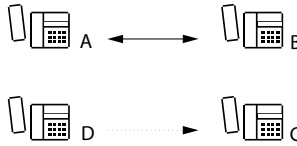

Fig. 223 Preparing to take over an active connection

Detailed Description

Tab. 289 Preparing to take over an active connection

Interface	Operating sequence / signalling on the terminal	Scope
B	User B obtains the busy tone once C has taken the connection to A.	Possible interfaces: Internal
C		Possible interfaces: Internal
D	After preparing to take over the call or taking back the preparations for taking over the call, D obtains the acknowledgement tone.	Requirement: Authorization is enabled in the user configuration. This authorization can be set separately for call and data connections.

Application Example

At three football grounds reporters are reporting the match. Depending on the state of play, the broadcast director may want to make the connection available to one of the reporters.

The director can use the preconfigured keys on a terminal to prepare to take over the connections. All the moderator at the broadcast studio has to do is pick up the handset on his terminal (to which a hotline has been allocated with *88#) and he is immediately connected with the football ground. While he is talking, the director can prepare the connection for the next reporter, and so on.

Functions in prefix dialling

Tab. 290 Preparing to take over an active connection: Functions

Functions	Function codes
Preparations for taking over a call or a data connection from user B to user C	*87 B*C# (call) or with *84 B*C# (data connection)
Clearing the preparations for taking over a call or a data connection from user B to user C	#87 C (call) or with #84C (data connection)

System configuration

Tab. 291 Preparing to take over an active connection: System configuration

Parameter	Parameter value	Remarks
<i>Prepare call acceptance</i>	Yes	User configuration (user D)
<i>Prepare data transfer</i>	Yes	User configuration (user D)

9. 6. 23. 2 Accepting the connection

A user C can take over an existing call or data connection A-B if D has prepared the takeover.

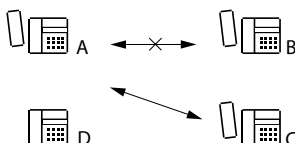

Fig. 224 Taking over an active connection

Detailed Description

Tab. 292 Taking over an active connection

Interface	Operating sequence / signalling on the terminal	Scope
B	User B obtains the busy tone once C has taken the connection to A.	Possible interfaces: Internal Restriction: Only simple connections can be accepted, not conferences, users on hold, etc.

Function in prefix dialling

Tab. 293 Taking over an active connection: Function

Function	Function code
Take over call / data connection	*88#

Reference to Other Features

Features:

- "Take (taking a call)", page 444
- "Fast take (pick up a call or a call connection)", page 445

9. 6. 24 Take (taking a call)

The Take function allows users to take over a call connection of another user without interrupting the connection or having the connection put through to them. The example below illustrates how to accept a call connection from a user with a cordless phone.

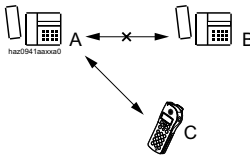

Fig. 225 Take (taking a call)

User A has set up a call connection with user B, who transfers the call to user C's cordless phone by pressing a key. Caller A is not aware that the call has been transferred.

Detailed Description

Tab. 294 Take (taking a call)

Interface	Operating sequence / signalling on the terminal
C	Activating via the configurable key on the cordless phone

System configuration

Tab. 295 Take: Key configuration

Function type	Note
In AMS or on the cordless phone the following command is used to prepare a configurable key to allow user C to take over user B's call: I *87 B * C # X I *88 #	Requirement: The <i>Prepare call acceptance</i> authorization must be enabled with user C. Restriction: Only simple connections can be accepted, not conferences, users on hold, etc.



Tip:

Take is actually nothing other than the preparation for accepting a call and accepting the call from the same terminal. This function can be carried out more simply using the Fast Take feature.

Reference to Other Features

Features:

- "Acceptance of a call or data connection:"; page 442
- "Fast take (pick up a call or a call connection)"; page 445

9. 6. 25 Fast take (pick up a call or a call connection)

The Fast take function combines and expands the two features Take a call and Pick up a call:

Fast Take allows an internally authorised user C

- to take an existing call connection between the internal or external user A and an internal user B.
- to pick up and therefore answer the incoming call from user A to user B.
- to take the outgoing call from user B to user A even before user A has answered the call.

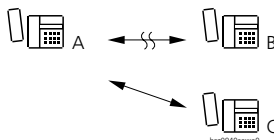

Fig. 226 Pick up a call connection or call with Fast Take

Detailed Description

Tab. 296 Fast Take

Interface	Operating sequence / signalling on the terminal	Scope
C	*88 <User No. B>	Requirement: • The <i>Fast Take</i> authorization must be enabled Valid for: • Calls to internal users, UG, CDE • Recall • Announcement • Simple connections with internal users or a user's own voice mailbox Restrictions: • Call to line key, appointment reminder call, recall • Conference participants, users on hold, etc.
B	User B obtains the busy tone once C has taken the connection to A.	Requirement: • <i>Fast Take protection</i> not activated Possible interfaces: • Internal

Function in prefix dialling

Tab. 297 Acceptance of a call or ringing connection: Function

Function	Function code
Pick up a call connection or a call	*88 <User No.>

System configuration

Tab. 298 Taking over an active connection: System configuration

Parameter	Parameter value	Remarks
<i>Fast Take</i>	<i>Yes</i>	User configuration (user C)
<i>Fast Take Protection</i>	<i>No</i>	User configuration (user B)

Application example

- DECT headsets logged on to the communication server as GAP cordless terminals usually have only one key (for seizing a call and hanging up). If a hotline with the content *88 <other user No.> is assigned to the key, all three possibilities described above will also be available on the DECT headset at the touch of a button. If a user has been assigned several terminals, the same can of course also be carried out with the terminals using *88 <own user No.>.

- An external or internal call is to be forwarded by someone who does not know how to transfer a call (for instance a child). It is now possible to take over the call from an authorised terminal.
- A call has been forwarded to the user's own voice mailbox. The call can now be taken with *Fast Take*.
- The quality on a cordless phone is poor. Instead of transferring the call, it can be taken directly by a desk phone.

Default settings

In the default setting, users do not have Fast Take authorization and are protected against Fast Take.



Note:

With TWIN users the protection against Fast Take is always inactive on both sides, regardless of the configured setting.

Reference to Other Features

Features:

- "Acceptance of a call or data connection:", page 442
- "Take (taking a call)", page 444
- "Picking up a call", page 413

9. 6. 26 Room monitoring (Baby surveillance)

This feature is designed specifically for monitoring infants. A cordless system phone (Office 135, Aastra 600d) is switched to a special monitoring mode and coupled with an internal or an external destination number.

If noise levels in the area surrounding monitoring phone A exceed a specific value, a call is automatically triggered to the configured destination B. When the destination user answers the call, the (one-way or two-way) connection is switched through. This is referred to as active room monitoring.

It is also possible to make a check call to the monitoring phone A. Without the call being signalled acoustically, A automatically answers the call and switches a (one-way or two-way) call connection through. This is referred to as passive room monitoring.

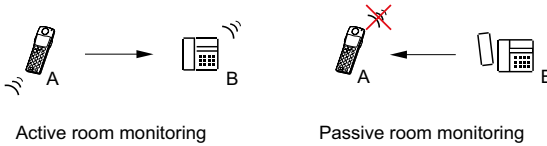

Fig. 227 Room monitoring (baby listening)

9. 6. 26. 1 Detailed Description

Tab. 299 Active and passive room monitoring

Interface	Operating sequence / signalling on the terminal	Scope
A	<ul style="list-style-type: none"> Once the feature is activated, A obtains a confirmation tone and a permanent indication on the display showing the destination user. A flashing exclamation mark indicates that the microphone is switched on at A (active room monitoring). 	Cordless phones on which room monitoring can be activated: <ul style="list-style-type: none"> Office 135/135pro Terminals of the series Aastra 600d Requirements so that a check call can be made from the outside: <ul style="list-style-type: none"> DDI is set up at user A. The caller's CLIP is not suppressed. Possible destinations: <ul style="list-style-type: none"> Users: internal, external, PISN
B		

9. 6. 26. 2 Functions

Room monitoring is activated on the monitoring cordless phone A:

Tab. 300 Active and passive room monitoring: Functions

Functions	Function codes
Activating room monitoring x = mode [1...3] ¹⁾ y = level [1...3] ²⁾ (optional)	*25 x <user No.> [* y] #
Cancelling room monitoring	#25 or using

¹⁾ x = 1: Active room monitoring with a one-way call connection.
 x = 2: Active room monitoring with a two-way call connection.
 x = 3: Passive room monitoring

²⁾ y: Sensitivity to noise (1: low, 2: average, 3: high, default value: 2)

9. 6. 26. 3 Active room monitoring

When activating room monitoring the user specifies whether the call connection should be one-way (mode 1) or two-way (mode 2). One-way means that only the transmission path of the monitoring phone is switched through; with a two-way call connection the reception path is also switched through (in hands-free mode). The duration of the call connection is limited to 1 minute.

As an option the user can specify the microphone's noise sensitivity level for triggering the call:

- Level 1: low sensitivity (high noise level required)
- Level 2: average sensitivity (average noise level required)
- Level 3: high sensitivity (low noise level required)

If no level is indicated, the value last selected is used.

The appropriate level has to be determined empirically on site.

The microphone used for room monitoring is switched on with a 10 second time lag (Office 135). On cordless phones of the Aastra 600d series the delay is configurable (10, 20 or 30 s). The time lag allows the user to position the cordless phone and then leave the room.

Triggering the call

If a noise exceeds the configured level for more than 2 seconds, a call is immediately triggered to the destination user.

- If the destination user is busy, the room monitoring microphone is re-activated after a 15 s delay.
- If the destination user still does not answer, the call is terminated and the room monitoring microphone is reactivated after a delay of 1 minute.



Notes:

- In both cases after the unsuccessful call the configured level has to be exceeded again for a call to be triggered.
- An ATAS alarm is also generated in addition to the call triggering. Use of the protocol is subject to *ATAS Interface* and *ATASpro Interface* licences.

During the call connection

During the call connection the destination user can use DTMF suffix dialling to switch back and forth between one-way and two-way mode and also cancel the time limit of 1 minute on the call connection:

- Digit 1: One-way call connection (modus 1)
- Digit 2: Two-way call connection (modus 2)
- Digit 5: Cancelling the time limit on the call connection.

The mode switchover and time limit cancellation apply to this connection only. Thereafter both the mode of the originally selected function and the time limits are reactivated.

Actively terminating the call connection

Besides automatically terminating the call after 1 minute, both the destination user and the user at the monitoring phone can prematurely terminate the call connection. In all cases the room monitoring microphone is reactivated after a delay of 1 minute.

Calls during active room monitoring

If an internal or external user calls the monitoring phone, the handset signals the call **only visually**, not acoustically. The call can be answered on the monitoring phone in the usual way. The monitoring phone can also be used to make an outgoing call. Once the call has been cleared down, the monitoring phone switches back to monitoring mode without delay.

If the destination user calls the monitoring phone, the phone temporarily switches to passive room monitoring (see next chapter).



Tips:

- Room monitoring is inactive while the monitoring phone is ringing. This gap in monitoring can be prevented by activating call forwarding on the monitoring phone. The destination user can still make a verification call as call forwarding does not apply to him.
- In each case the room monitoring microphone is reactivated after the delay times. This is indicated by the flashing exclamation mark on the display of the monitoring phone.



Notes:

- Room monitoring based on DECT technology cannot be 100% reliable.
- Extraneous noises in the monitored room call lead to false calls.
- Therefore no liability can be assumed for failed monitoring calls or for false calls.

9. 6. 26. 4 Passive room monitoring

Passive room monitoring allows the destination user to listen into a room using a verification call. To do so, he calls the monitoring phone on which room monitoring is activated. The phone automatically answers the call without any acoustic signaling and switches the connection through. This is also the case when call forwarding has been activated on the monitoring phone.

The check call is possible in all three monitoring modes. The connection type however is different:

- Room monitoring in modes 1 and 3:
→ The call connection is one-way.
- Room monitoring in mode 2:
→ The call connection is two-way.

During the call connection

As with calls set-up by the monitoring phone in active room monitoring the user has the possibility of switching back and forth between one-way mode (digit 1) and two-way mode (digit 2) once the connection has been set up with DTMF suffix dialling. The switchover is temporary.

Terminating a call connection

There is no time limit to the duration of a verification call, which must be terminated by the user on the destination phone or by the user on the monitoring phone. Once the call has been cleared down, the monitoring phone switches back to monitoring mode without delay.

Calls during passive room monitoring

If another internal or external user calls the phone on which passive room monitoring is activated (mode 3), the phone signals the call **visually and acoustically** and the call can be answered in the usual way.



Tip:

Passive room monitoring is indicated on the monitoring phone by the display reading *Room monitoring for ...*; no exclamation mark is displayed. Note: The same display is also shown with active room monitoring before a delay expires. This is due to the fact that the status “active room monitoring with deactivated microphone” is equivalent to passive room monitoring.

9.6.27 Conversation recording

This feature allows you to record an internal or external call and send it to one or more e-mail addresses as a wave file (G.711 format). It is also possible to record a conference.

Conversation recording with a system phone is either started manually via the Fox key or through a function key, or automatically during each call. If started manually, conversation recording can be stopped at any time. This allows partial conversation recording.

Detailed Description

Tab. 301 Conversation recording

Operating sequence / signalling on the phone	System phones	Other phones
<ul style="list-style-type: none"> Start or stop the call recording using the Foxkey, function key or automatically with every call. When call recording is in progress, a symbol appears in the display of system phones (except on the Aastra 6700i). 	<ul style="list-style-type: none"> Aastra 2380ip Aastra 6000 Aastra 1560 / Office 1560 Terminals of the series Aastra 5300/Aastra 5300ip Terminals of the series Aastra 6700i Aastra Mobile Client plus 	Only automatic call recording is possible.

Call recording can be started and stopped in the following situations:

- In a call connection
- In a conference call
- During an incoming/outgoing call
- During dialling with call preparation
- During dialling with the line seized (overlap dialling)

The recording begins only once the call connection has been established. This means that no ring back tones or hold tones are recorded.

If an enquiry call is made, the recording is temporarily interrupted and an e-mail is sent containing the call as recorded up to that point. The recording automatically restarts as soon as the call connection with the enquiry call party is set up and/or as soon as the call connection with the original call party resumes.

The maximum recording time for each wave file depends on the configuration of the parameter *Maximum e-mail size [Mbyte]* with SMTP server (CM_2.2.6). The setting 2 MByte corresponds to approximately 2 minutes recording time. The recording time increases by approx. 2 minutes for each additional MByte. If the maximum

recording time is reached, the system stops recording and sends a wave file to the defined e-mail address(es). At the same time the system automatically starts a new recording and stores it in a second wave file, etc. This way no conversation information is lost, and recordings overlap each other by about 2 seconds.

The subject line of the e-mails sent consists of the name of the recorded wave file included as an attachment; it is comprised as follows:

Tab. 302 E-mail subject

CallRec~CLIP-A_[Name-A]~CLIP-B_[Name_B]~...CLIP-F_[Name-F]_YYYYMMDD_HHMMSS_File No.	
CallRec	Designation for call recording.
CLIP-A	CLIP of the user who started the call recording.
[Name-A]	Name of user A, where available.
CLIP-B...CLIP-F	CLIP of the other call parties involved (up to 5 in a six-party conference).
[Name-B]...[Name-F]	Name of users B...F, where available.
YYYYMMDDDD	Date of the start of the recording.
HHMMSS	Time of the start of the recording.
File No.	If there are several files within the same recording, the file number is incremented (1...n).

Scope

The following conditions must be fulfilled before a user can start recording a conversation:

- The SMTP server is configured in the system configuration.
- At least one e-mail address is configured at the user's.
- The user is assigned a permission set, on which the authorisation for *Conversation recording* is set to *Manual*. (If authorisation is set to *Automatic*, conversation recording cannot be started manually).
- The *Enterprise Voice Mail* licence is available and at least one audio channel is available for conversation recording.
- Internal DECT-DECT connections cannot be recorded.
- If the recording is made on an IP or SIP phone, additional VOIP channels may sometimes be required to convert voice data.

When a call is forwarded the settings for call recording at the user's, to whom the call is transferred, is decisive.

Once the wave files are sent by e-mail, they are erased from the communication server.

System configuration

Tab. 303 Call recording: System configuration

Parameter	Parameter value	Remarks
Settings for access to the <i>SMTP</i> server		System configuration (CM_2.2.6)
<i>Conversation recording</i>	<No / Manual / Automatic>	Authorization set assigned to the executing user (CM_4.5).
<i>E-mail address</i>	<E-mail address >	User's e-mail address (CM_4.1).
<i>Send call recording to user's e-mail address</i>	<Yes / No>	If other e-mail addresses have been entered for the call recording, this value can be configured to <i>No</i> (CM_4.1).
<i>E-mail addresses call recording</i>	<E-mail address_1, e-mail address_2...>	E-mail addresses are entered separated by commas (CM_4.1).
<i>Reserved for call recording or Not reserved/sharable</i>	<Number of voice channels>	At least one voice channel must be available in order to enable call recording (CM_5.1.5).



Notes:

Conversation recording may violate existing data protection regulations in your country, or may only be allowed on certain conditions. Notify your correspondent in advance if you wish to use the conversation-recording function.

Reference to Other Features

Features:

- "Voice mail system", page 382

9.7 Special features

Here describes features that are available only in combination with a special application or supplementary equipment, e.g. announcement service or door bell.

9.7.1 Coded ringing on general bell

The installation of a general bell feature provides a paging system, albeit with a limited scope. Up to five internal users can be paged using a specific coded ringing on the general bell. A user who recognizes his ringing pattern can answer the call from any terminal B.

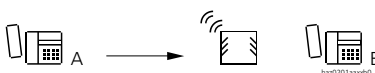

Fig. 228 Coded ringing on general bell

Detailed Description

Tab. 304 Search via coded ringing on general bell

Interface	Operating sequence / signalling on the terminal	Scope
A	<ul style="list-style-type: none"> A obtains the ring-back tone A obtains the busy tone (the display reads <i>Unavailable</i>) if the general bell is busy (queue full). 	Possible interfaces: The function is activated locally on the system.
B		

Coded ringing consists of a long tone followed by n number of shorter tones ($n = 1 \dots 0.5$) and is set via the system configuration.

Coded ringing can be used as the destination for a Call Forwarding Unconditional.

Functions

Tab. 305 Coded ringing on the general bell: Functions in prefix dialling

Functions	Function codes
Activate coded ringing	*81 User No.
Activate CFU to coded ringing	*28
Clear CFU to coded ringing	#28
Answer coded ringing	*82

Tab. 306 Coded ringing on the general bell: Suffix dialling function

Function	Function code	System phones	Analogue terminal
Activate coded ringing	*81		R8 or R*81 (R = control key)

System configuration

Tab. 307 Coded ringing on the general bell: System configuration

Parameter	Parameter value	Remarks
<i>Coded ringing</i>	<User No.> for variant <1 to 5>	
<i>Coded ringing</i>	<Variant>	User configuration

9.7.1.1 Answer general bell

A call can be signalled on the general bell (ringing signal) and be answered by any user B who hears it.



Fig. 229 Answer ringing signal on general bell

Detailed Description

General bell is activated via user group (UG) or via proxy.

If other calls are routed to the general bell, they are placed in a queue (max. 10 entries).



Tip:

General bell in the UG of the operator console with delay:
If the attendant is absent for a short time (or is overloaded), the general bell is activated after the delay time. Employees who hear the ringing tone can then answer the call.

Function in prefix dialling

Tab. 308 Answer general call: Function

Function	Function code
Answer ringing signal on general bell	*83

System configuration

Tab. 309 Answer general call: System configuration

Parameter	Parameter value	Remarks
General Bell	Yes	User group
General Bell	Yes	Substitution

9. 7. 1. 2 General bell on analogue terminal interface FXS

The general bell is connected to an analogue terminal interface FXS. Precisely one FXS interface per communication server can be configured for this purpose. Any existing allocation to a user is then automatically deleted.

Once the connection is made, no calls can be made or received via the port.



Aastra Intelligent Net:

In an AIN a general bell can be configured per node.

System configuration

Tab. 310 Analogue port for general bell: System configuration

Parameter	Parameter value	Remarks
General Bell	Yes	Interface configuration

Reference to Other Features

Features:

- "Call Forwarding Unconditional (CFU)", page 339
- "Call Forwarding on No Reply (CFNR)", page 346
- "User group: Logging in and logging out", page 472

9.7.2 Announcement service

The announcement service is for incoming external calls, but if required it can also be used for internal calls via a call distribution element. If a call from A is not answered within a preset delay time by internal user B (who is either free or for whom call waiting is enabled), the caller will hear a welcome announcement (provided the call has not been rerouted to the alternative destination (Capolinea)¹⁾ beforehand). Once the announcement has been made, the caller obtains either the ring-back tone, music, a pause or another announcement is made. This can be repeatedly endlessly, with the possibility of playing back up to 20 different Wave files. A succession consisting of wave life, pause signal and pause duration is referred to as a sequence.

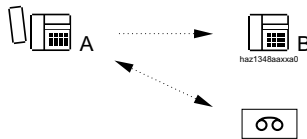

Fig. 230 Announcement service

As long as caller A is connected with announcement service, user B's terminal continues to ring. If B answers, the connection is put through immediately.

If B does not answer within the time configured under *CM_2.3.3.2_ Internal ringing duration* in the AMS Configuration Manager, the connection is cleared down.

Detailed Description

Tab. 311 Announcement service

Interface	Operating sequence / signalling on the terminal	Scope
A	If the internal user answers during the recorded announcement, the announcement is interrupted.	Possible interfaces: <ul style="list-style-type: none"> External internal, if the call is routed via a CDE
B	The internal user's set continues to ring while the welcome announcement is being played.	Requirement: Announcement service is not activated if B has activated a Call Forwarding Unconditional to an external destination (exchange-to-exchange connection).

¹⁾ Only for Italy

**Note:**

For the caller to hear the welcome announcement, a through-connection has to be made on the exchange side, i. e. from that moment onwards the caller incurs call charges.

Welcome announcements

It is possible to define up to 20 (Aastra 415/430) or 50 (Aastra 470) welcome announcements. A welcome announcement comprises one or more (up to 20) sequences. In each sequence the parameters of the following table are to be configured in AMS under CM_5.4_ *Welcome announcements*:

Tab. 312 Configuration per sequence of a welcome announcement

Parameter	Parameter value	Remarks
<i>File number</i>	<10...29>	The file number is also included in the name of the wave file.
<i>Pause signal</i>	<Ring back tone / External audio source / Internal audio source / Do not disturb>	This determines what is to be played in the pauses between the sequences.
<i>Pause duration</i>	<0...30> seconds	The default value is 15 seconds. If the pause duration is 0, the sequence skips directly to the next.
<i>Next sequence</i>	<1...20>	If the entry is the same sequence, it is repeated endlessly. If the entry is blank or if it points to a non-existent sequence, the welcome announcement ends.

These configuration possibilities can be used to define complex welcome announcements. An example of a welcome announcement with 3 sequences is given below. The welcome announcement ends after sequence 3, and music is played until the time configured under *Internal ringing duration* in CM_2.3.3_ *Time settings* has elapsed. The connection is then cleared down.

Tab. 313 Example of a welcome announcement

<i>Sequence</i>	<i>File number</i>	<i>Pause signal</i>	<i>Pause duration [s]</i>	<i>Next sequence</i>
1	10	<i>Ring-back tone</i>	15	2
2	11	<i>External audio source</i>	30	3
3	12	<i>External audio source</i>	30	

It is also possible to define endless loops that consist of one or more sequences. Example: If the figure 2 is entered as the next sequence at sequence 3, sequences 2 and 3 are repeated until the connection is cleared down.

Other settings in *CM_5.4_Announcement service*:

Each welcome announcement can be individually activated or deactivated using the *Status* parameter. The *Delay* parameter can also be configured within a range of 0 to 100 seconds for each welcome announcement (default value: 10 s). This value defines the amount of time before the unanswered call is answered by the announcement service. The *Announcement service for internal users* parameter is a parameter that applies throughout the system. It determines whether or not internal calls routed via a call distribution element are to be answered by the announcement service.

Allocation in the call distribution elements

The allocation of a call to a predefined welcome announcement of the announcement service is made in the call distribution elements under *CM_3.1.4_CDE destinations*, depending on a switch group's switch position. The position of the switch group assigned to the call distribution element via which the call is to be routed is always crucial. The welcome announcements for the various switch positions can be the same or different.



Note:

An assigned welcome announcement is played only if its *Status* is configured to *Activated* in *CM_5.4_Announcement service*.

Besides the customised welcome announcements the two predefined entries *Stop* and *Music* can also be assigned. This makes sense particularly when forwarding to a different CDE (see section below).

Forwarding to a different call distribution element

If the incoming call that has already been routed to the announcement service is forwarded to a second CDE (e. g. by CDE overflow or a default call forwarding at the user's), the current welcome announcement is broken off and the assigned welcome announcement of the second CDE is played instead.

Special configurations

- If no welcome announcement is assigned at the second CDE or if the assigned welcome announcement is deactivated, the welcome announcement of the first CDE continues to be played.
- If at the second CDE the *Stop* welcome announcement is assigned, the caller obtains the *Ring back tone* pause signal. If previously the caller was not yet connected through to the announcement service (e. g. with CDE overflow when busy), a through-connection is now made on the exchange side.

- If at the second CDE the *Music* welcome announcement is assigned, the caller obtains the *External audio source* pause signal. If previously the caller was not yet connected through to the announcement service (e. g. with CDE overflow when busy), a through-connection is now made on the exchange side.
- If the user makes an enquiry call to the CDE call number, after the set delay he will obtain the welcome announcement assigned to that CDE. When the call is then transferred by hanging up, the delay timer is restarted and the welcome announcement is played to the caller from the beginning.
- Callers routed from the Auto Attendant to a CDE call number via voice mail can also be connected with the announcement service.

Other properties

The system has three (Aastra 415/430) or six (Aastra 470) parallel voice channels.

- If another call occurs during a welcome announcement, the second call is switched to announcement service via a second channel once the delay has expired.
- If all channels are busy, the next caller is put on a hold position. He will obtain the ring-back tone until a channel once again becomes free or until he can be synchronised with the start of a current welcome announcement.
- If an endless loop is defined for a welcome announcement, callers on several voice channels can be synchronized with the same announcement text on the same channel. This frees up channels for new callers. The requirement is that the pauses of the same welcome announcement overlap chronologically during the playback.

The announcement service is also available in the following cases:

- If the external call's destination is a PISN user in a QSIG network who has activated the announcement service locally in his node.
- If an internal user has forwarded to a PISN user in a QSIG network who has activated the announcement service locally in his node.

The call routing, the delay setting, the definition of the welcome announcements and their assignment to the switch positions in the call distribution elements can only be carried out by the Installer in the system configuration.

Recording announcements

Announcements can be recorded either with a phone or via an audio device connected to the audio input (Aastra 415/430) or an FXS interface in the *External audio*

source (Aastra 470 mode). The recordings made in this way are stored as audio files in the file system of the communication server. It is also possible to record announcements with a PC, store it as a wave file, and then upload it on to the communication server.

Recording with a phone or audio equipment:

Tab. 314 Announcement service: Recording functions

Functions	Function codes ¹⁾
Recording a welcome announcement with a phone	*911 xx [*nn] #
Recording a welcome announcement with audio equipment	*921 xx [*nn] #
Check recording	*#911 xx [*nn] # or *#921 xx [*nn] #
Delete recording	#911 xx [*nn] # or #921 xx [*nn] #

1) "xx": File number <10...29>
 []: the digits within the brackets are optional
 "nn" stands for the node number. If no node number is indicated, the node used is that of the phone with which the functions are carried out. With IP system phones this is always the Master; with cordless phones it is the node at which the phone is currently located.)



Notes:

- A user can only carry out the function codes if he has been allocated an authorization profile with the right *Audio services*. Also the user PIN must not be set to the default value "0000".
 Exception: The function for checking the recording is not affected by this restriction.
- A PISN user can only operate the control functions of his own local communication server using the */# function codes.

Recording with the phone:

After the function code is entered, a start tone is audible and can be recorded over the handset.



Note:

Loss of quality is to be expected when recording using DECT, IP or SIP phones.

Recording with audio equipment:

After the function code is entered, a start tone is audible, and it can be played back via the audio input on the communication server. The recording can be monitored via the handset.

The following applies to both recording possibilities:

- To end the recording, hang up; on system phones press the *Stop* Foxkey. The recording is then stored automatically.
- The recording time is limited by the length of time defined in AMS for this recorded announcement. Once this time has expired, the recording stops automatically and the audio data is stored.

Recording with the PC:

Announcements can also be recorded with a PC through a connected microphone (e. g. with the Windows Audio Recorder). The recordings have to be stored as wave files in a particular format under a predefined name.

- Format: CCITT A-Law, 8 kHz, 8 bit, mono
- File names: court_xx.wav (lower case required)

"xx" can take on the values 10...29.

The wave files with the announcements must be uploaded onto the communication server's file system:

1. From the AMS Shell select the communication server, enter the access data and log in.
2. In the AMS shell under *Tools - Manage audio data - Upload audio data - Upload files for announcement service only*, use the *Add* button to select one or more wave files.
3. Use *Upload* to upload the Wave files onto the file system.

The files are available to the application as soon as they are on the communication server file system. We recommend that you use the corresponding function codes to check the texts by listening to it (see [Tab. 314](#)).



Notes:

- Wave files with incorrect format cannot be played.
- Wave files that are longer than the time available as defined in AMS under *CM_7.2_File management* cannot be loaded and will generate a corresponding error message.



Tips:

- Before the announcements are used for the first time, the wave files are automatically renamed (from name.wav to name.used.wav). This allows new recorded announcements texts to be uploaded onto the file system while announcements are being made. Before an

announcement is restarted a check is carried out to see whether the file system contains a new file with the original name (name.wav). If so, the old file is deleted, and the new file is renamed and played back.

- To prevent existing files from being overwritten, they can first be renamed in the communication server's file system using AMS under *CM_7.2_File management*.

Activating / deactivating welcome announcements

The announcement service cannot be activated or deactivated globally; instead, the individual welcome announcements are activated or deactivated. If several users share the same welcome announcements, they can only be deactivated individually in the call distribution elements. However this configuration can only be changed by the installer via AMS.

Tab. 315 Announcement service: Activation functions

Functions	Function codes ¹⁾
Activate welcome announcement	*931 yy [*nn] #
Deactivate welcome announcement	#931 yy [*nn] #

¹⁾ "yy": = welcome announcement <01...20> for Aastra 415/430 or <01...50> for Aastra 470
 []: the digits within the brackets are optional
 "nn" stands for the node number. If no node number is indicated, the node used is that of the phone with which the functions are carried out. With IP system phones this is always the Master; with cordless phones it is the node at which the phone is currently located.)



Note:

- For the function codes to be carried out, the user must be assigned an authorization profile with the administration right *Audio services*. Also the user PIN must not be set to the default value "0000".
- A PISN user can only operate the control functions of his own local communication server using the */# function codes.



Aastra Intelligent Net:

- In an AIN, announcements can be recorded on both the master and the satellites. The parameters for the welcome texts can also be configured for each node. The announcement service used is always that of the node through whose exchange interface the call is received.
- It is not possible to upload the announcements of a satellite via the Master using AMS. However the files can be displayed, renamed and deleted in the file system of the nodes via the Master.

- The number of welcome announcements and voice channels in an AIN is determined by the Master: If an Aastra 470 is used as the Master, each node also has 50 welcome announcements and 6 simultaneous voice channels at its disposal, regardless of the type of communication server used there.
- With IP system phones the Master's announcement service is always used; with cordless phones it is the node at which the phone is currently located.

9.7.3 Clear configurations

With this function each user has the possibility of clearing all the personal functions he has activated with the exception of night service, logging in/out in user groups, status of CLIR permanent, and appointment orders.

Detailed Description

Tab. 316 Clear settings

Interface	Operating sequence / signalling on the terminal
A	The user obtains an acknowledgement tone once the function has been executed.

This applies to the following features:

- Do not disturb
- Follow me
- Call Forwarding Unconditional
- Call Forwarding on No Reply
- Call back
- Protection against CFU/CFNR
- Protect against intrusion
- Protect against announcement
- Protect against call waiting

Function in prefix dialling

Tab. 317 Clear configuration: Function

Function	Function code
Clear configuration	*00 or #00

System configuration

Tab. 318 Clearing settings: System configuration

Parameter	Parameter value	Remarks
No settings		

Reference to Other Features

See list above

9.7.4 LCR Function

If the LCR function is activated, dialled call numbers are analysed and converted. This means that the communication server may actually dial a different call number than the one entered by the user (see ["LCR function"](#), page 208).

Users can be authorized through the user configuration to dial using network providers of their own choice, contrary to the set LCR criteria (see ["Bypassing LCR manually \(Forced Routing\)"](#), page 219).

If a network provider cannot be reached and the communication server detects this, it will automatically try and reach an alternative network provider (provided that function is activated). If a network provider cannot be reached and the communication server does not detect this, the user has the possibility of dialling the alternative provider manually using *90 (see ["Alternative Routing \(Fallback Routing\)"](#), page 215).

9.7.5 Emergency numbers

The system is equipped with emergency numbers, which can be used by all internal users. Emergency calls are routed to a destination B preconfigured in the system configuration.

Detailed Description

Tab. 319 Emergency number

Interface	Scope
B	Possible interfaces: internal, external, PISN

A total of 10 emergency numbers can be created in the numbering plan. The emergency numbers are used to quickly dial an emergency number destination.

A total of 50 emergency number destinations with three destination numbers each can be configured. A separate emergency number destination can also be assigned to each terminal. This destination takes priority over the destination assigned in the system configuration.

A destination number can be stored for each of the three switch positions of switch groups 1 to 20. When an emergency number is dialled, one of the three destination numbers is dialled.



Note:

If an external destination with exchange access prefix code is specified, it is important to ensure that a route is assigned to each user.

System configuration

Tab. 320 Emergency number: System configuration

Parameter	Parameter value	Remarks
<i>Emergency number</i>	<Call number>	Numbering plan
<i>Emergency number destination</i>	<1 to 50>	Destinations
<i>Name</i>	<Name of the emergency number destination>	System configuration
<i>Switch group</i>	<1 to 20>	
<i>Destination for switch position 1..3</i>	<Destination numbers>	Terminal configuration
<i>Emergency number destination</i>	<1 to 50>	



Note:

The emergency number can also be the destination of a hotline and can be configured differently for each of the three possible switch positions.

Example: Hotline on lift telephone

Switch position 1 (day): 11, switch position 2 (night): 175 and switch position 3 (weekend): 0118.

Note: In this case it is useful to create a special emergency number destination, to assign three destination numbers to it and to store it under the terminal data. The emergency number destination configured throughout the system, for which other destination numbers may be stored, can then be used by "ordinary" users.



Aastra Intelligent Net:

In an AIN the nodes can be located in different countries, which means it makes sense to enter in the numbering plan the emergency number normally used in each country. Depending on the assigned emergency desti-

nation and the switch position of the configured switch group the corresponding destination number is then dialed whenever the emergency number is dialed.

If the nodes are located in the same country but in different regions separate emergency number destinations can be defined for alarming the local emergency services. These destinations must then be assigned accordingly in the node configuration.

Terminal-related response:

The following applies provided no emergency number destination is configured on the corresponding terminal:

- Desk phones and virtual terminals use the emergency destination assigned to the node.
- Cordless phones use the emergency destination of the node at which the phone is currently located.
- IP system phones use the emergency number destination assigned to the Master.

9.7.6 Suppression of the call number display

The display of the call number to the called party can be suppressed (CLIR). CLIR can be permanently activated or deactivated for each user in the Configuration Manager. Each user can also use a */# function code to activate or deactivate CLIR either permanently or only temporarily for a single call.

Detailed description of temporary CLIR

CLIR is activated temporarily using *31 before dialling an external call number. If CLIR is already permanently activated, it can be deactivated temporarily using #31 before dialling. The permanent CLIR settings are restored once the call is completed.

Scope

Suppressing the call number display is supported only for external calls via digital network interfaces with the DSS1 protocol.



Notes:

- The function is not executed when used in connection with ISDN supplementary services in the exchange such as ECT, PARE or CD, i.e. the call number is displayed to the called party.

- Depending on the network provider and service provider it may be necessary to subscribe to CLIR.

Suppressing the call number display is not possible in the following cases. The outgoing call is rejected; the display reads *Not available* and the user obtains the busy tone:

- External calls via analogue exchange interfaces
- Internal calls and calls to PISN users or virtual network PISN users
- In combination with an abbreviated dialling that contains other */# function codes
- In combination with dialling using a line key

Functions

Tab. 321 CLIR per user: Functions

Functions	Function codes
Activate CLIR for one call	*31 external destination No.
Deactivate CLIR for one call	#31 external destination No.
Activate CLIR permanently	*31#
Deactivate CLIR permanently	#31#

System configuration

Tab. 322 CLIR per user: System configuration

Parameter	Parameter value	Remarks
CLIR	Yes / No	User configuration

Reference to Other Features

Features:

- "Suppressing CLIP / COLP (CLIR / COLR)", page 77
- "Displaying Numbers (CLIP) and Names (CNIP)", page 69

9.7.7 Recording malicious calls (MCID)

By activating the Malicious Call Identification service, MCID for short, a user B can have the threatening or nuisance calls from an external user A recorded by the network provider so that the caller can be identified. The recording can be activated either during the call or after the call during the busy tone signalling (once the caller has rung off).

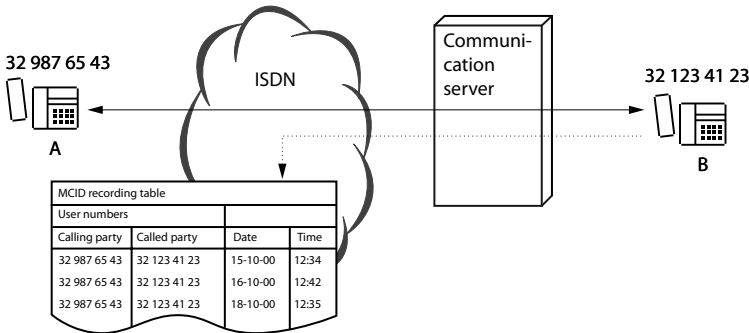

Fig. 231 MCID during the call

Detailed Description

This function provided by the network provider as a supplementary service is used for identifying malicious or nuisance callers. The identification is effected by the network provider. The feature is activated by the user.

Suppressing the outgoing number (CLIR) does not protect the caller from identification of his user number by the network provider.

The following data is recorded by the network provider:

- Calling party's phone number
- Called party's phone number
- Date and time of the call

Tab. 323 Recording of malicious calls

Interface	Operating sequence / signalling on the terminal	Scope
B	Activate during the call / after the call during the busy tone signalling ¹⁾ . Network provider confirms activation (the type of signalling is specific to the network provider)	Internal user Connection restrictions: <ul style="list-style-type: none"> • Only for external incoming connections • In hands-free mode, activation is practically possible only during the call as system phones hang up automatically within a few seconds of the end of the call.
A		External user

¹⁾ The duration of the busy tone signalling after the call depends on the network provider.

Tab. 324 Recording of malicious calls: Prerequisites

Prerequisites	Communication server
Technical	The communication server must be directly connected with the ISDN network (no support in the private network) Terminals: <ul style="list-style-type: none"> • System phones (configurable only with AMS on the Office 10) • ISDN terminals
Administrative	Must be applied for as a supplementary service from the network provider
Legal	A court injunction must be required depending on the legislation in the region concerned

Suffix dialling function

Tab. 325 Recording of malicious calls: Suffix dialling function

Function	System phones	ISDN terminal
Activate MCID	MCID is available as */# function F16#1# in the function selection list, and can be configured onto a function key	Menu or function key

System configuration

Tab. 326 Recording of malicious calls: System configuration

Parameter	Parameter value	Remarks
No settings		

Reference to Other Features

Features:

- "Identification elements", page 67

9.7.8 User group: Logging in and logging out

Members of user groups can log themselves out and back in again. The logout and login procedure can apply simultaneously for all the user groups or specifically for one user group only.

Detailed Description

Tab. 327 User group

Interface	Operating sequence / signalling on the terminal	Scope
A	<ul style="list-style-type: none"> When logging in or out, A obtains an acknowledgement tone in each case. If the function is configured on a key with LED display, the status logged out/in will be displayed. 	Requirement: <ul style="list-style-type: none"> A is member of one or several user groups Restriction: <ul style="list-style-type: none"> The last remaining member of a user group cannot log himself out. Does not apply to operator console and general bell

If a member activates a CFU to an external destination, a PISN user or voice mail, he may automatically be logged out. The response depends on the configuration (see section "[Call Forwarding Unconditional \(CFU\) for user group members](#)"; page 138).

With user groups configured as "large", the UG member is logged out for all types of redirected calls, even internal ones.

The "Clear configuration" feature (*00 or #00) does not affect the logging in/out of UG members.

Functions in prefix dialling

Tab. 328 User group: Functions

Functions	Function codes
Log in to all user groups	*4800
Log out of all user groups	#4800
Log into one user group	*48 <UG No.>
Log out of one user group	#48 <UG No.>

The logging in/out of UG members is also possible via AMS.

System configuration

Tab. 329 User group: System configuration

Parameter	Parameter value	Remarks
<i>User groups (UG)</i>	Members <user No.> for <UG No.>	Call routing
<i>User group</i>	<Call numbers> for <UG No.>	Numbering plan

Reference to Other Features

Features:

- "Coded ringing on general bell", page 455
- "Call Forwarding Unconditional (CFU)", page 339

9.7.9 Home alone

If calls to a user group can only be answered by one user, that user can activate the *Home Alone* feature on the user group.

If the user is then making a call, all other internal or external callers to the user group will obtain the congestion tone.

If the user in the user group is assigned several terminals, the parameter *Busy if busy* must be configured to *Yes* for that user.

Detailed Description

Tab. 330 Home alone

Operating sequence / signalling on the terminal	Scope
<ul style="list-style-type: none"> • The user obtains an acknowledgement tone in each case when activating/clearing Home Alone. • If the function is configured on a key with LED display, the status will be displayed. The LED lights up when the feature is activated. 	

- A UG with activated *Home Alone* is busy if at least one of the UG's users is in an outside call or an internal call.
- If a user is in several line groups with "Home Alone" activated and if he is in a call, callers to one of the UGs will obtain "busy".

Functions in prefix dialling

Tab. 331 User group: Functions

Functions	Function codes
Activate Home Alone	*49 UG No.
Clear Home Alone	#49 UG No.

System configuration

Tab. 332 Home alone System configuration

Parameter	Parameter value	Remarks
<i>Home alone</i>	Yes	CM_2_1_5
<i>Busy if busy</i>	Yes	CM_3_2_5

Application Example

The Smith family run a carpentry workshop in the same building as their home. During office hours Mrs Smith runs the office (user D). While she is making calls on that particular phone, calls to the private or business number should obtain the busy signal. Mr Smith, however, can be reached in any case by his staff via DDI (user E).

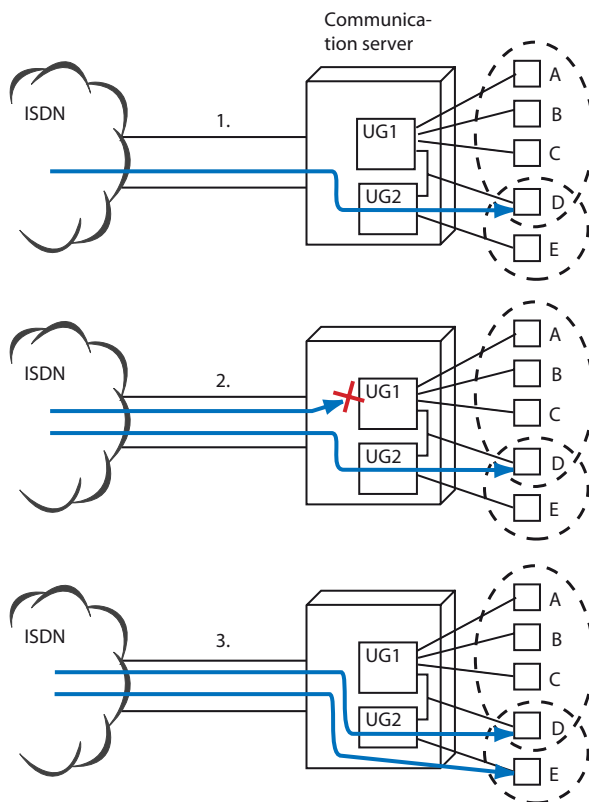

Fig. 232 Home alone

UG 1 (Private) contains users A, B, C and D. User D is also in UG 2, along with user E (carpentry workshop). Home Alone is activated in both UGs.

1. An incoming outside call to the business number is answered by Mrs. Smith at the office (user D).
2. All other internal and outside calls to UG 1 and UG 2 will obtain "busy".
3. Mr. Smith (user E) can still be reached by his staff from the outside via DDI.

9.7.10 Switching switch groups

Switch groups defined in the system configuration can be selected by user A using switch contacts or a function code from the terminal. The switchover can also be carried out automatically using time-controlled functions in the System Configuration (see "Time-controlled functions", page 493)

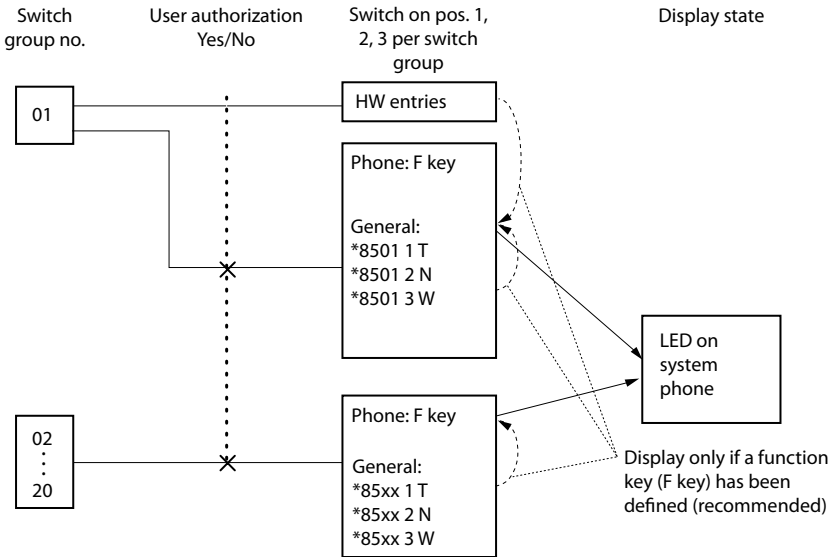

Fig. 233 Switching switch groups

Detailed Description

Tab. 333 Switching switch groups

Interface	Operating sequence / signalling on the terminal	Scope
A	<ul style="list-style-type: none"> The user obtains an acknowledgement tone when switching On / Off. Terminals connected to the S-bus cannot display the status of switching groups 2 to 20. System phones: The switching status is displayed by the status of the LED or the corresponding symbol on the display for the function key configured accordingly. 	Possible interfaces: The switch groups are operated locally on the system.



Tip:

Identify the significance of the switching states on the labels of the terminals.

External switches:

The switch groups can also be activated via control inputs, e.g. via a preconfigured time-switch clock.

External switches have a higher priority, i.e. they must be open (status 0) so that switching via function key, function code or AMS can be carried out.

Function in prefix dialling

Tab. 334 Switching switch groups: Function

Function	Function code
Switch switching group x in position y	*85 xx y (xx = 01...20, y = 1..3)

System configuration

Tab. 335 Switch groups: System configuration

Parameter	Parameter value	Remarks
<i>Operate switch group</i>	Yes	User configuration
<i>Switching position</i>	Switch position of switch group 1 to 20	Function code and AMS configuration are equivalent, i.e. the change last made chronologically is the effective one.
<i>Card control input</i>	Node number and slot number	Several switch groups can be allocated to one card.

Reference to Other Features

Features:

- "Emergency numbers", page 466
- "Door bell", page 480
- "Announcement service", page 458

9.7.11 Switch control outputs

Various equipment or installations can be controlled using control outputs on FXS interfaces or the ODAB options card (Aastra 415/430). The telephone can be used to operate sun blinds, for example, or to switch the lighting on or off throughout the building.

Detailed Description

Tab. 336 Switch control outputs

Interface	Operating sequence / signalling on the terminal	Scope
A	The user obtains an acknowledgement tone every time he activates / deactivates the feature.	Possible interfaces: The function is activated locally on the system. Requirement: Authorization is enabled in the user configuration.

Functions in prefix dialling

Tab. 337 Switch control outputs: Functions

Functions	Function codes
Activate control output	*74 <Call number ¹⁾ >
Deactivate control output	#74 <Call number ¹⁾ >

¹⁾ call number assigned to this control output in the numbering plan

Provided they have not already been defined, call numbers can be created in the numbering plan. Numbers already created can be deleted again or changed.



Tip:

Store function code under a function key

System configuration

Tab. 338 Controlling control outputs: System configuration

Parameter	Parameter value	Remarks
Switch control outputs	Yes	User configuration
State	On / Off	Function code and AMS configuration are equivalent, i.e. the change last made chronologically is the effective one.



Aastra Intelligent Net:

In an AIN control outputs can be used as a mix of FXS interfaces and ODAB options cards (Aastra 415/430 only). An authorized user can switch all the control outputs, regardless of where they are located. The call numbers of all control outputs of an AIN are defined in the numbering plan.

Reference to Other Features

Features:

- "Open door", page 481

9.7.12 Door function

There are two ways of connecting a door intercom (TFE):

- Using an options card ODAB (only Aastra 415/430)
- Via an analogue terminal port FXS

In a connection using an options card, the equipment or installation is controlled via relays and a control input on the options card.

In a connection using an analogue terminal port the TFE must be capable of sending and receiving DTMF signals as the control is effected acoustically via a speech path.

On the analogue terminal port the parameter *FXS mode* must be configured to *two-wire door*.

The following functions are available with both connection variants:

- Door bell triggers a call
- Open door
- Dial door intercom

9.7.12.1 Door bell

Depending on the system configuration, pressing the door bell triggers a call to any internal destination B.

Detailed Description

Tab. 339 Door bell

Interface	Operating sequence / signalling on the terminal	Scope
B	<ul style="list-style-type: none"> When the door bell is activated the allocated destination will ring with a special ringing tone. The ringing time is limited to 20 seconds. If B is busy, he will obtain call waiting except if he himself is already in an enquiry call. <i>Call waiting on exchange connection</i> and <i>Protect against call waiting</i> are not taken into account. 	<p>Possible interfaces: Users: internal, PISN, UG</p> <p>Restriction:</p> <ul style="list-style-type: none"> If user B has diverted to an external destination, the connection to the door intercom will be switched through. The connection created with the door intercom is limited to 5 minutes (forced disconnect) if the call partner (PISN or external) is connected to the public network.

Door bell input on an options card

- The door bell is connected directly to a control input of the options card.
- One internal user can be allocated to the door bell input for each case of the Day, Night and Weekend positions.
- The dialled destination is dependent on the position of switch group 1 if another switch group is not assigned to the control input of the option card.

Tab. 340 Door bell on the options card: System configuration

Parameter	Parameter value	Remarks
<i>Door intercom system</i>	Destinations <user No.> for switch position <1,2,3>	

Door bell when the door intercom system is connected via an analogue terminal port

- The destination is configured directly in the connected TFE.
- If the dialled destination depends on the position of a switch group, a CDE call number must be entered in the TFE.

Function in prefix dialling

Call user: via the door bell.



Aastra Intelligent Net:

In an AIN the configured destinations must not be on the same node as the connected door intercom.

Reference to Other Features

Features:

- "Open door", page 481
- "Dial door intercom", page 483

9.7.12.2 Open door

This function actuates the door opener of any door.

If the TFE is connected via an options card a relay which opens the door is activated for three seconds.

If the door intercom system is connected via an analogue terminal port the corresponding analogue port is called. When the call is answered by the TFE the configured DTMF characters are transmitted automatically to open the door.

Detailed Description

Tab. 341 Open door

Interface	Operating sequence / signalling on the terminal	Scope
A	Once the feature has been activated, the user obtains the acknowledgement tone.	Requirement: Authorization is enabled in the user configuration.

Functions / system configuration for connection via options card

Tab. 342 Opening doors: Function

Function	Function code
Open door	*74 <Call number of the door intercom>

Tab. 343 Opening doors: System configuration

Parameter	Parameter value	Scope / remarks
<i>Open door</i>	Yes	Necessary authorisation of the user who wants to carry out the function.
<i>Door intercom system</i>	<Call number>	The number is defined in the numbering plan.

Functions / system configuration for connection via analogue port

Tab. 344 Opening doors: Function

Function	Function code
Open door	*74 <Call number of the user who is assigned an analogue terminal to whose port the door intercom system is connected>

Tab. 345 Opening doors: System configuration

Parameter	Parameter value	Scope / remarks
<i>Open door</i>	Yes	Necessary authorisation of the user who wants to carry out the function.
<i>User</i>	<Call number>	The number is defined in the numbering plan.
<i>Door opener DTMF sequence</i>	<DTMF sequence>	The DTMF sequence must match the door opener sequence in the TFE. If necessary, one or more pauses "P" can be entered before or within the sequence. Each "P" represents a 1 s pause. Example: PP1P2P3



Tip:

Store the function code on a function key (I*74 call number)



Aastra Intelligent Net:

In an AIN an authorized user can actuate all the door openers of the connected door intercom system, regardless of the node to which they are connected.

Reference to Other Features

Features:

- "Door bell", page 480
- "Dial door intercom", page 483

9.7.12.3 Dial door intercom

A door intercom can be dialled by user A in the same way as he would dial an internal user.

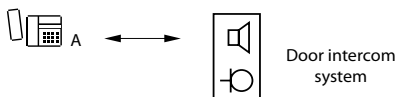

Fig. 234 Connection to the door intercom

Detailed Description

Tab. 346 Dial door intercom

Interface	Scope
A	<p>The door intercom can be dialled up:</p> <ul style="list-style-type: none"> • Locally on the system • From another PINX¹⁾ dialling. <p>Requirement: Authorization has been enabled in the user configuration (digit barring).</p>

¹⁾ The door intercom can be entered in the PINX numbering plan as a PISN user (see "Numbering plan", page 43).

Functions / system configuration for connection via options card

Dial the door intercom:

Dial the door intercom number. (After initialization: 851, 852)¹⁾

Tab. 347 Door intercom: System configuration

Parameter	Parameter value	Remarks
<i>Door intercom system</i>	<Call number>	The number is defined in the numbering plan.

Functions / system configuration for connection via analogue port

Dial the door intercom:

Dialling of the call number of the user who is assigned an analogue terminal to whose port the door intercom system is connected.

¹⁾ Only with Aastra 415/430 and if the corresponding number of ODAB card(s) is fitted

System configuration

Tab. 348 Door intercom: System configuration

Parameter	Parameter value	Remarks
User	<Call number>	The number is defined in the numbering plan.

Reference to Other Features

Features:

- "Door bell", page 480
- "Open door", page 481

9.7.13 System time and system date

The system time and system date are used as information in many areas, for instance for the display on system phones, for call logging, for event messages, etc. The system time and system date are also required for the appointment reminder call and the time-controlled triggering of */# function codes.

Functions in prefix dialling

Tab. 349 System time and system date: Functions

	Function codes	Legend
Set up the system time	*57 hh mm	hh = hour <00...23> mm = minute <00...59>
Set up the system date	*58 dd mm yyyy	dd = day <00...31> mm = month <00...12> yyyy = year <1980...2999>

The system time and system date can also be remote controlled from the outside.

Function codes *57 and *58 are usually barred in the internal digit barring.

The system time and system date can also be set in AMS. Besides setting the time AIMS can also be used to select whether the system time should switch automatically between summer and winter time (CM_1_2_5, Parameter see Tab. 350).

Time synchronization

It is possible to set up a time synchronization via ISDN network or via IP using a time server:

ISDN time synchronisation:

The ISDN time synchronization can be activated or deactivated in the Configuration Manager (CM_1_2_11).

UTC Time synchronisation:

UTC is the basis used for synchronizing via a time server. UTC stands for Coordinated Universal Time and corresponds to the earlier designation GMT (Greenwich Mean Time). The NTP (Network Time Protocol) is used for transmission. A public or local NTP server can be used. The address or name of the NTP server and the time difference with UTC is entered in AMS under CM_1_2_5. The NTP service can be activated or deactivated.



Notes:

- If a name is entered for the NTP server the DNS settings (CM_1_4_2) must also be configured.
- The ISDN time synchronization and NTP service must be activated simultaneously.



Aastra Intelligent Net:

In an AIN there are additional configuration parameters for time synchronization between the nodes.

The Master is always in AIN area 1. This area is always assigned the Master time. Time differences with other nodes can now be configured based on the Master time.

Example: Master is in Switzerland; satellite is in Finland. The time difference with UTC is: CH +01:00, FI +02:00.

Entry for the Master: *Time zone shift* : 00:00

Entry for the satellite: *Time zone shift*: +01:00

If the time is synchronized via an NTP server the parameter *Time difference with UTC (+/- hh:mm)* must also be configured to +01.00 as the Master time differs from UTC by 1 hour.

System configuration

Tab. 350 System time and system date: System configuration

Parameter	Parameter value	Legend / Remarks /
<i>System time</i>	<hh:mm:ss>	Invalid times are not accepted
<i>system date</i>	<dd.mm.yyyy>	Possible data: 01.01.1980...31.12.2999
<i>Automatic changeover to summer time</i>	Yes / No	The time change is synchronized throughout the European Union and in many other countries
<i>Time difference with UTC (+/- hh:mm)</i>	Yes / No	In an AIN depending on the Master's location

Parameter	Parameter value	Legend / Remarks /
<i>NTP service</i>	<i>Yes / No</i>	
<i>NTP Server</i>	<Address or name>	If name is entered, configure DNS settings
<i>ISDN time synchronisation</i>	<i>Yes / No</i>	Usually assigned to only one AIN region
<i>Master time</i>	<i>Yes / No</i>	Information field. Always in the AIN region 1 in which the Master is also located.
<i>Time zone shift</i>	<±hh:mm>	±12 hours in steps of 15 minutes

Reference to Other Features

Features:

- "Appointment reminder call", page 440
- "Time-controlled functions", page 493
- "Remote controlling features from outside the system", page 491

9.7.14 Free seating

Free seating is intended for workstations that are used by several staff members. With free seating each member of staff is able to log in to a non-personalised phone with his call number and PIN and personalise that phone for a specific amount of time. During that time he uses the phone with or without his personal settings. Phones that are set up for free seating belong to a free seating pool.

Free seating pool

You assign phones for free seating use to a free seating pool rather than a user. You can set up several free seating pools and assign several phones to each free seating phone. However each phone can only belong to one free seating pool.

When a user logs in to a free seating phone, the phone is taken out of the free seating pool and assigned to that user. When the user logs out again, the phone goes back to the free seating pool. In other words the user temporarily borrows the phone from the free seating pool. During that time the phone adopts all the user's properties.

The free seating pool itself has properties similar to those of a user. These properties remain effective for as long as no user logs in to the free seating phone.

Personal settings of the logged user

You can specify whether in addition to the user properties (call number and name, call lists, phone book, permission set, caller identification, call forwarding, and others) the terminal settings (user language, key assignments, audio properties) of the

logged user are effective (default) or whether the terminal settings of the free seating pool are to be used (*Use personal terminal profile* setting).

If a user logs in with the default setting and he is already assigned a phone of the same type, the settings are adopted by the free seating phone. If not, the defaults for that phone type are adopted.

The user can adapt the terminal settings to his requirements in the usual way, directly on the phone. He may for example reconfigure certain keys or change the ring melody. These settings are saved and will be available to him again the next time he logs in.

Tab. 351 Free seating pool User configuration

Parameter	Parameter value	Scope / remarks
<i>Automatic logout</i>	<No / Logout after / Daily at>	<i>No</i> : The user has to log out of the free seating phone <i>Logout after</i> : The user is automatically logged off once the set time has expired. The time begins to run down as soon as the user has logged in. <i>Logout at</i> : The user is logged out every day at the set time.
<i>Logout time</i>	<hh:mm>	<i>Logout after</i> : Enter the duration in hours and minutes. <i>Logout at</i> : Enter the time.
<i>Use personal terminal profile</i>	<Yes / No>	The terminal settings (user language, key assignment, audio properties) of the logged-in user are adopted or not.
<i>PIN required to logout</i>	<Yes / No>	To log out, the free seating user must enter his PIN (default) or not.

9.8 Remote control features

A large number of features can be remote controlled either from within or outside the system:

- Remote controlling features from within the system:
User A activates / deactivates a feature on user B (Tab. 352)
- Remote controlling features from outside the system:
An external user A activates / deactivates a system-related feature (Tab. 353) or a user-related feature on the internal user B (Tab. 352).



Note:

The total number of digits dialled for each remote-controlled feature (for external remote control as of *06) must not exceed 32 (with the remote control of *47 and long PINs for example, this can be critical).

Tab. 352 User-related features remote-controlled from within and from outside the system

Feature	Activate	Reset
Clear configuration	*00 or #00	
Protect against / allow CFU/CFNR on own set	*02	#02
Protect against / allow call waiting/intrusion on own set	*04	#04
Activate / clear CFU	*21 destination No.	#21
Activate / clear CFU Unconditional on user last configured	*21#	#21
Activate / deactivate presence status	*27 Profile No. [hhmm] [ddmm] #	#27 or *27 0 #
Activate / clear CFB	*67 destination No.	#67
Activate / clear CFB on user last configured	*67#	#67
Activate / clear CFU to preconfigured user	*22	#22
Activate / clear CFU to standard text or activate / clear leave message	*24 text No. param.	#24
Activate / clear room monitoring ¹⁾ (x = mode 1...3; y = level 1...3)	*25 x user No. [* y] #	#25
Activate / clear Do not disturb	*26	#26
Activate / clear CFU to general call with coded ringing	*28	#28
Permanent suppression of the call number display (CLIR)	*31#	#31#
Send text messages (standard texts) to user	*3598 user No. text No.	
Send text messages to group	*35 Gr. No. text No.	
Send text messages to all	*3599 text No.	
Activate / clear Message function	*38 SC No.	#38 SC No.
Personal call routing	*45 x	#45
Change PIN (x: old PIN, y: new PIN)	*47 x * y * y #	
Log into / out of all UG	*4800	#4800
Enter one missing item (minibar)	*51 Art. No. #	
Enter several missing items (minibar)	*51 Art. No. * Number #	
Enter cleaning status	*52 <State> #	
Enter maintenance notice / delete all	*53 Code #	#53 #
Charge amount to guest room	*54 <Art. No.> * <Amount> #	
Log into / out of one UG	*48 UG No.	#48 UG No.
Activate / clear individual order for appointment call	*55 hh mm	#55
Activate / clear permanent order for appointment call	*56 hh mm	#56
Activate / clear CFNR	*61 destination No.	#61
Activate / clear CFNR to user last configured	*61#	#61
Activate / clear CFNR to preconfigured user	*62	#62
Activate / clear call forwarding to general call with coded ringing	*68	#68
Trigger Redkey function	*73 <Parameter> #	

Feature	Activate	Reset
Record voice mail greeting with phone (x=1,2,3)	*913 x user PIN #	
Check voice mail recording (x=1,2,3)	*#913 x user PIN #	
Delete voice mail recording (x=1,2,3)	#913 x user PIN #	
Record voice mail greeting with audio device (x=1,2,3)	*923 x user PIN #	
Activate voice mail greeting (x=1,2,3)	*933 x user PIN #	
Deactivate voice mail greeting (x=1,2,3)	#933 x user PIN #	
Listen to voice messages with audio guide	*#94 user PIN #	
Listen to voice messages without audio guide	*#916 user PIN #	

¹⁾ only Office 135/135pro, Office 160pro/Safeguard/ATEX and phones of the Aastra 600d series

Tab. 353 User-independent features remote-controlled from within and from outside the system

Feature	Activate	Reset
Set up the system time	*57 hh mm	
Set up the system date	*58 dd mm yyyy	
Operate switch groups	*85 <Switch group><Pos.>	
Actuate door opener	*74 <No. of the door intercom system>	
Switch control outputs	*74 <Call number ¹⁾ >	#74 <Call number ¹⁾ >
Home alone	*49 UG No.	#49 UG No.

¹⁾ call number assigned to this control output in the numbering plan



Note:

With external remote control of features CFU and CFNR (*21, *61 and *67) the destination number has to be defined in the internal numbering plan. External destinations can therefore only be reached using abbreviated dialling.

9.8.1 Remote controlling features from within the system

A user A can use function code *06 to carry out features from his terminal on behalf of another authorized user B.

Example:

An internal user activates call forwarding on no reply:

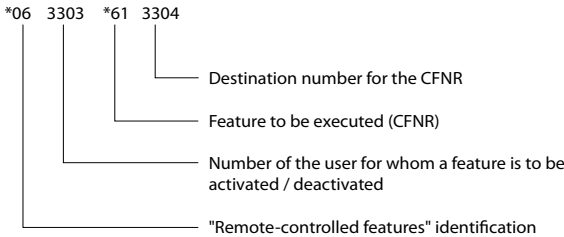

Fig. 235 Example of remote control

Detailed Description

Tab. 354 Remote controlled features

Interface	Operating sequence / signalling on the terminal	Scope
A	When activating and deactivating the feature the user carrying out the feature obtains the acknowledgement tone.	Possible interfaces: <ul style="list-style-type: none"> • A and B are on the same system Requirements: <ul style="list-style-type: none"> • For user A, *06 is not barred in the internal digit barring. Requirement: <ul style="list-style-type: none"> • User B is not protected against remote control.
B		

System configuration

Tab. 355 Internal remote control: System configuration

Parameter	Parameter value	Remarks
Protection against Remote Control (user B)	No	User-specific
Internal digit barring user A	*06 enabled	User-specific

Reference to Other Features

Features:

- "Remote controlling features from outside the system", page 491

9.8.2 Remote controlling features from outside the system

An external user A can use a DDI number specially set up for remote control and a password valid throughout the system to remote-control a group of features via the public ISDN network (External Remote Control or ERC). The features concerned can be either user-related features of an user B (Tab. 352) or system-related features (Tab. 353).

Detailed Description

Tab. 356 Externally remote-controlled features and system functions

Interface	Operating sequence / signalling on the terminal	Scope
A	<ul style="list-style-type: none"> • A dials the call number for remote control • After 5 seconds of ringing the connection is established and A obtains the internal dial tone. The communication server automatically switches to DTMF mode. • A enters his password followed by "#". • A again obtains the internal dial tone • A dials *06 ... (as for internal remote control). 	Possible interfaces: <ul style="list-style-type: none"> • Public ISDN network Requirements: <ul style="list-style-type: none"> • DTMF-compatible telephone. • Valid password
B		Requirement: <ul style="list-style-type: none"> • User B is not protected against remote control.

Function in prefix dialling

Tab. 357 External remote control: Function

Function	Dial string with function code
Execute feature with function code using external remote control	<DDI No.> < Password> #*06 <user No.> <*/# function code>

Example:

An external user activates call forwarding on no reply:

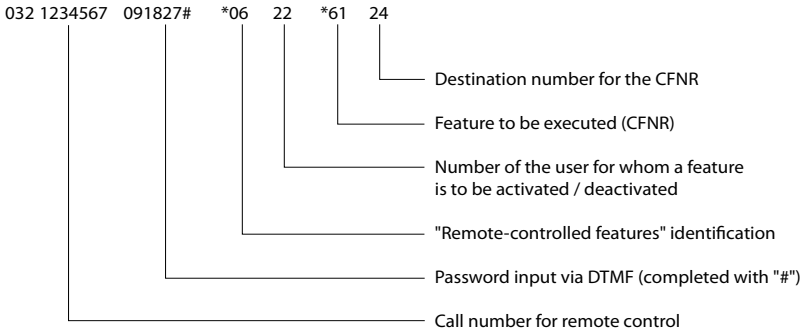

Fig. 236 Sequences for external remote control of features

Security elements:

- Password protection (change the password at regular intervals using AMS or the System Assistant on Office 45).
- External remote control barring throughout the system.
- Protection for user B for remote control access.
- Reduction in the choice of remote-controlled features using the special digit barring facilities of the external remote control
- Time limit when entering the remote-control sequence:
The */# function codes have to be entered within 12 seconds; thereafter the connection is cleared down automatically.
- Access logging:
Remote control attempts from the outside are logged in the incoming call logging (ICL). If the attempt is successful, the DTMF sequence is entered in the field *Dest. No.1*. Unsuccessful attempts are entered with the sort character xx9 (only in PC5 format; see "Structure of the PC5 output format", page 286).

System configuration

Tab. 358 External remote control: System configuration

Parameter	Parameter value	Remarks
<i>Password</i>	6 digits exactly with digits (0 to 9)	Adjustable throughout the system at the attendant authorization (also with the System Assistant on Office 45)
<i>Enable</i>	Yes	
<i>Digit barring</i>	Selects the internal digit barring for switch position 1 to 3 of switch group 1	Default values: <ul style="list-style-type: none"> Digit barring settings: 8/8/8 (Aastra 415/430) 16/16/16 (Aastra 470) Digit barring 8/16: *85, *75, #75 barred
<i>Protection against Remote Control</i>	No	User-specific (enable remote control of the user's terminal)
<i>DDI number</i>	<ERC DDI number>	Create DDI number for ERC and link with CDE
<i>CDE destination</i>	ERC	Can only be entered once a valid password has been entered

Reference to Other Features

Features:

- "Remote controlling features from within the system", page 490

9.8.3 Time-controlled functions

Up to 50 (Aastra 470 up to 500) time-controlled functions (*/# function codes) can be defined in the System Configuration to be executed once at a particular time on a particular date. It is also possible to define recurring functions to be executed at a particular time on a particular weekday or every weekday. The */# function codes can be used for user-specific features or for settings applicable throughout the system.

Unlike the control of features or the modification of configurations via the terminal, time-controlled functions are not subject to the authorisations or to the digit barring that apply to individual users.

Tab. 359 Examples of time-controlled functions:

No	Function codes	Start (Day)	Stop (Day)	Execution date	Execution time	Switch group	Meaning
1	*0620#21	Monday	Friday		08:00		Deactivate CFU of user 20
2	*0620*2124	Monday	Friday		16:30		CFU from user 20 to user 24
3	#74 854			20.12.2002	22:00		Deactivate control output 854 (e.g. heating)
4	*74 854			06.01.2003	05:30		Activate control output 854 (e.g. heating)



Tip:

The function is not carried out if neither an execution date nor a start / stop range is defined. This allows you to deactivate entries in the table without having to delete them.

Features and settings can also be activated, deactivated and modified with time control and in parallel via terminals. Each particular status is event-controlled, i.e. the last command chronologically determines the current status. The previous statuses of the functions are not verified. If a function is removed from the table, its status is also retained.



Note:

Invalid entries in the function column which cannot be executed do not trigger an error message.

Switch Group Assignment

Each function can be assigned one of the switch groups 1 - 20. This allows you, for example during holiday periods, to activate or deactivate whole groups of functions. All functions with allocation of the corresponding switch group are active on switch position 1 and inactive on switch positions 2 + 3.

Tab. 360 Activating/deactivating functions via switch groups:

No	Function codes	Start (Day)	Stop (Day)	Execution date	Execution time	Switch group	Meaning
5	*931 02	Monday	Friday		07:00	7	Activate welcome announcement 02 of the announcement service
6	#931 02	Monday	Friday		18:00	7	Deactivate welcome announcement 02 of the announcement service

No.	Function codes	Start (Day)	Stop (Day)	Execution date	Execution time	Switch group	Meaning
7	*85072			20.12.2002	18:30		Switching from switch group 7 to switch position 2: All functions allocated switch group 7 are deactivated.
8	*85071			06.01.2003	06:30		Switching from switch group 7 to switch position 1: All functions allocated switch group 7 are activated.

**Note:**

When switch groups are switched over, the functions are maintained in their status at the time.

Available Functions

All remote-controlled functions can be activated with time control. User-specific features are activated with *06 <user No.>. For an overview of the functions available see [Tab. 352](#) and [Tab. 353](#). In addition to the remote-controlled features the following functions can also be activated using time control:

Tab. 361 Additional time-controlled functions

Feature	Activate	Reset
Activate / deactivate welcome announcement of the announcement service	*931 <No of the welcome announcement>	#931 <No of the welcome announcement>
Enable/bar a one-off remote access	*754,	#754
Enable/bar a permanent remote access	*753	#753

Special restart function

In addition to the control using */# function codes a time-controlled restart of the system is also possible. The "reset" character sequence is entered to obtain this function. After it has been saved to the communication server, AMS indicates the function "time-dependent pbx reset". As a result the "reset" function command remains hidden to unauthorized users. After a reset the entry is automatically deleted. A reset using a time-controlled function is clearly identified by the error ID 08625 in the crash log.

**Aastra Intelligent Net:**

In an AIN the execution of a time-controlled function is always determined by the Master's time. A time zone shift configured for a node is not automatically taken into account.

9.9 Accommodation/Hotel

The Aastra 400 communication server offers you two modes for implementing an accommodation and hotel solution, with different configuration tools, operation possibilities and interfaces:

Hospitality mode = V2

- User-friendly solution configurable using the AMS Configuration Manager or WebAdmin.
- Functions operated using the Aastra 5380/5380ip reception phone or the web-based Aastra Hospitality Manager application.
- Connection to a Property Management System (PMS) via the communication server's Ethernet interface. The commercially available FIAS protocol is provided for this purpose.

Hospitality mode = V1

- Simple solution configurable with the AMS Hotel Manager or the System Assistant on the Office 45/45pro.
- Functions operated using the System Assistant on the Office 45/45pro.
- Connection to a Property Management System (PMS) via the communication server's Ethernet interface. A proprietary command set is available for this purpose.

Select the mode *V2 (Aastra 400 Hospitality) for new hospitality configurations* (default value). The hospitality views will then be available to you in the WebAdmin, the Aastra Hospitality Manager, the WebAdmin Hospitality administrator access and also the PMS interface. For a more detailed description see "[Features in mode V2](#)", [page 496](#) Hospitality mode *V1 (Hotel functions)* guarantees compatibility with older Hotel configurations that were implemented with the help of the Hotel functions. You will need the AMS Hotel Manager for the configuration. For a more detailed description see "[Features in mode V1](#)", [page 505](#).

9.9.1 Features in mode V2

The features in mode V2 are designed to implement a user-friendly accommodation and hotel solution. This solution is also ideally suited for the management of care homes and retirement homes.

The following features are covered:

- Check-in/Check-out
- Automatically executable functions at Check-in (e. g. delete guest data) and Check-out (e. g. print bill).
- Barring room-to-room traffic
- Display and management of the room status
- Assignable permission sets depending on room status
- Cleaning status of rooms with maintenance notices
- Wake-up service and notification service
- Set up a hotline and a surcharge calculator for each room
- Print and reset call charges
- Editable HTML and TXT templates for call charge invoices
- Monthly invoice for call charge invoices by e-mail
- General settings using the AMS Configuration Manager or WebAdmin.
- Supports the analogue Aastra 6710a and Aastra 6730a phones.
- */# function code for the maintenance staff to change the room status, leave maintenance notices or book out minibar items.

9.9.2 Configuration and operating concept

The basic configuration is carried out using either the AMS Configuration Manager or WebAdmin. To carry out the basic configuration using WebAdmin, you need to log in as administrator. You then have access to the Hospitality Configuration Assistant, which guides you through the necessary configuration steps.

Depending on the size of the establishment, various applications and interfaces can be used to operate the functions:

- Smaller establishments (3 to 20 rooms):
 - Functions operated using the Aastra 5380/5380ip reception phone.
 - Cost-effective solution with intuitive user interface.
 - No licence required.
 - See also Aastra 5380/5380ip User's Guide.
- Medium-sized establishments (10 to 100 rooms):

- Functions operated by the receptionist using the web-based Aastra Hospitality Manager application integrated in the communication server (no installation required).
 - Up to 5 parallel receptionists are possible.
 - At-a-glance display and enhanced functionality.
 - Templates for creating customized call charge invoices.
 - Online Help available.
 - One licence (per communication system) is required for operation.
- Larger establishments (up to 400):
 - Functions operated using the external application of a Property Management System.
 - PMS interface to connect the Property Management System via the commercially available FIAS (Fidelio Interface Application Specification) protocol.
 - The use of the PMS interface is subject to a licence (for each communication system and for each room).

The diagram below provides an overview of the various configuration and operating possibilities:

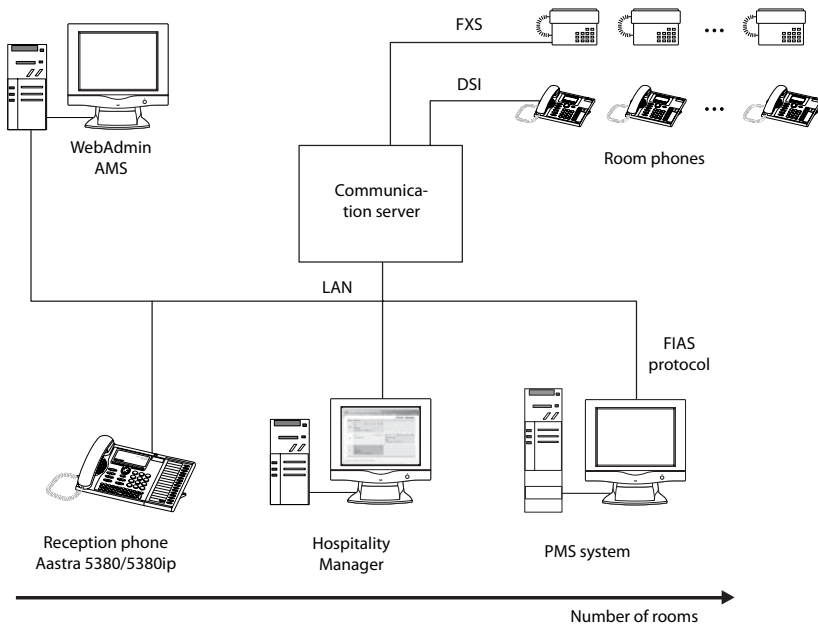

Fig. 237 Overview of configuration and operating possibilities

Once the basic configuration is in place, you have the possibility to log in to the WebAdmin as Hospitality Administrator. This function contains all views that are required to set up Aastra Hospitality Manager and the Reception menu in Aastra 5380/5380ip and to define the default values. You can also use a menu item to launch the Aastra Hospitality Manager.

If you log in to the WebAdmin as Receptionist, the Aastra Hospitality Manager starts directly.

9.9.3 Network printer and Aastra 400 Print Spooler

The network printer is used to print out the call charge invoices via the Aastra 5380/5380ip reception phone. It is activated via the Aastra 400 Print Spooler. Install the print spooler on a computer with maximum availability within your IP network and on which the printer you want is set up.

The print spooler provides three ports, allowing you to activate up to three printers independently of one another. It processes both print orders for TXT and HTML templates. For TXT orders you can also specify format properties such as page borders and fonts.

You can download the Aastra 400 Print Spooler from the Aastra Software Download Server or source it from your distribution partner.

As an alternative to the Aastra 400 Print Spooler, you can also connect a serial printer directly to the communication server via an IP adapter and a switch for small businesses without IT infrastructure. For example: Epson thermal line printers combined with IP adapters manufactured by AK-Nord, Germany, are suitable for this purpose. The serial printer must support the UTF-8 or WPC1252 codepage.

9.9.4 Function codes in prefix dialling

Room cleaning status

The maintenance staff can use a function code to change the cleaning status of a specific room. There are 3 states: *Not cleaned*, *Cleaned* and *Checked*.

The function codes can be executed on the room phone or any other internal phone.

Tab. 362 Room cleaning status: Functions

Functions	Function codes
Enter cleaning status	*52 x #
Enter cleaning status on another internal phone	*52 x * <Room No.> #
x = cleaning status: 1 = Not cleaned, 2 = Cleaned, 3 = Checked	

Maintenance notes

The maintenance staff can use a function code to leave maintenance notices for a specific room. These maintenance notices and the relevant maintenance codes are listed in a table in the Configuration Manager under CM_2.6.3 *Maintenance codes*.

Once the maintenance work has been completed, Technical Services for example can delete a room's maintenance notices.

The function codes can be executed on the room phone or any other internal phone.

Tab. 363 Maintenance notices: Functions

Functions	Function codes
Enter maintenance notice	*53 <Maintenance code> #
Delete all maintenance notices for the room	#53 #
Enter maintenance notice on another internal phone	*53 <Maintenance code> * <Room No.> #
Delete all maintenance notices for the room on another internal phone	#53 <Room No.> #

Minibar

The maintenance staff can use a function code to record minibar items consumed in a specific room.

The items are not stored on the communication server, but forwarded to a connected PMS system.

The function codes can be executed on the room phone or any other internal phone.

Tab. 364 Minibar: Functions

Functions	Function codes
Enter a missing item	*51 <Item No.> #
Enter several missing items	*51 <Item No.> * <Quantity> #
Enter a missing item on another internal phone	*51 <Item No.> * 1 * <Room No.> #
Enter several missing items on another internal phone	*51 <Item No.> * <Number> * <Room No.> #

Charge direct

Charge direct allows guests to purchase items from internal retail points (e. g. kiosks) without the use of cash; the sales staff can then charge the purchase directly to the guest's room.

The amounts are not stored on the communication server, but forwarded to a connected PMS system.

The function codes can be executed on the room phone or any other internal phone.

Tab. 365 Charge direct: Functions

Functions	Function codes
Charge amount to guest room	*54 <Item No.> * <Amount> #
Charge amount to the guest's room on another internal phone	*54 <Item No.> * <Amount> * <Room No.> #
Item number: Max. 5 digits, amount: indicate in cents	

Notification service

Alongside system phones, most analogue phones have a message LED. The LED is activated if for example there is an internal callback or a new voice mail voice message waiting for the guest. If the guest answers using his phone's preconfigured answer key, a call is triggered or he is connected with the voice mail system so he can listen to his voice message.

Tab. 366 Notification service: Function

Functions	Function codes
Answer notification	*#38



Note:

This function code is also used for "ordinary" users that have not been created as room guests (see "Message function", page 418). In an accommodation and hotel environment, however, the way in which the notification is triggered and the response to the answer are handled differently.



Tip:

Store function code under a key.

Wake-up service

The function codes for the wake-up service are identical to those of the appointment reminder call (see "Appointment reminder call", page 440).

In an accommodation and hotel environment, however, a number of additional settings can also be configured, e.g. the type of wake-up announcement and the amount of time during which the wake-up call remains active if the guest phone is busy. If the wake-up call is not activated on the guest phone itself, it can also be carried out on another internal phone using remote control (*06).

9.9.5 System configuration

Tab. 367 CM_2.6.1 General settings: System configuration

Parameter	Parameter value	Remarks
<i>Reception</i>		
• <i>Reception Desk number</i>	<Call number>	Enter here the internal call number of the reception.
<i>Room settings</i>		
• <i>Delete guest data on</i>	<Check-in / Check-out>	Here you can specify whether the guest data that has been entered is deleted on <i>Check-out</i> or only on <i>Check-in</i> of the next guest.
• <i>Check-in Room-to-Room</i>	<Retain current value / Enabled / Not enabled>	You can specify here the standard permission settings for calling from one room to another. This setting is assigned during check-in, and can be manually overwritten using Aastra Hospitality Manager.
• <i>For 'Occupied Normal'</i>	<No. - [Name]>	Permission sets contain settings which regulate user permissions. You can specify here which permission sets should be used for the guest rooms, depending on the room status. The selected permission set is active when a guest room is occupied.
• <i>For 'Occupied Alternative'</i>	<No. - [Name]>	The selected permission set is active if a guest room is occupied and the alternative permission set was selected in the Aastra Hospitality Manager.
• <i>Permission set if room is free</i>	<No. - [Name]>	The selected permission set is active if the room is free.
<i>Cleaning settings</i>		
• <i>Hospitality cleaning support</i>	<Yes / No>	<i>Yes:</i> The display of the cleaning status in the Aastra Hospitality Manager is activated. The status can be set by authorised personnel.
• <i>Room dirty at checkout</i>	<Yes / No>	On Check-out the cleaning status is automatically set to <i>Not cleaned</i> .

Parameter	Parameter value	Remarks
<ul style="list-style-type: none"> Room dirty every night 	<Yes / No>	Every day at 3 am the cleaning status is set to <i>Not cleaned</i> .
<p><i>Wake-up call settings</i></p> <ul style="list-style-type: none"> If busy, the wake-up call remains active for Greeting Mode 	<p><1...100></p> <p><Attention tone / Standard announcement in several languages></p>	<p>If the guest is busy on the phone at the time of the wake-up call, the wake-up call cannot be put through. However it does remain active for a certain amount of time and is put through as soon as the line is free. Here you can specify the amount of time during which the wake-up call remains active (in minutes). Once that time has expired, the active wake-up call is cancelled, and Reception obtains a message stating that the wake-up call could not be put through.</p> <p>You can specify here what the guest hears when they answer the wake-up call.</p>
<p><i>Billing</i></p> <ul style="list-style-type: none"> VAT List Incoming Calls Alternative Currency Standard surcharge calculator Monthly bill E-mail destinations for monthly bills 	<p><xx.xx> %</p> <p><Yes / No></p> <p><xx.xx></p> <p><- / 1...4></p> <p><Yes / No></p> <p><n@n, m@m, ...></p>	<p>Enter the current applicable VAT rate here.</p> <p><i>Yes:</i> Incoming calls are also itemised on the bill.</p> <p>If you wish to make the bill out in a different currency, you can enter the exchange rate you want here. Make sure you use a template for the correct currency.</p> <p>A surcharge can be applied to call charges using a surcharge calculator. Depending on the surcharge-calculator configuration, the surcharge consists of a basic surcharge and a charge-based surcharge. The call charge display on the phone always indicates the call charges incl. surcharge. This is where you assign the surcharge calculator to be used for room phones.</p> <p>The monthly bill is used to calculate the call charges of long-term guests.</p> <p><i>Yes:</i> The call charges are cumulated on a monthly bill at the end of the month and sent as a ZIP file to the set e-mail destinations.</p> <p>Enter here the e-mail addresses to which the monthly bill will be sent. Separate the individual e-mail addresses with a comma.</p>
<p><i>Maintenance notes</i></p> <ul style="list-style-type: none"> Send as text message to user Send to e-mail address (destination x) 	<p><User number></p> <p><n@n></p>	<p>You can send maintenance notices as a text message to a user. However, this only makes sense if the user has a system phone capable of displaying the text message.</p> <p>You can send maintenance notices as an e-mail. Two e-mail destinations can be defined.</p>

Parameter	Parameter value	Remarks
<ul style="list-style-type: none"> E-mail subject (destination x) Send to Property Management System (PMS) 	<p><Text></p> <p><Yes / No></p>	<p>A separate subject line can be defined for each e-mail address. The actual maintenance notice is copied to the body of the e-mail.</p> <p><i>Yes:</i> Maintenance notices are sent to the connected Property Management System (PMS).</p>
<i>Printer</i>		
<ul style="list-style-type: none"> Printout at check out IP address Port Print format 	<p><Yes / No></p> <p><IP address></p> <p><Port></p> <p><Text / HTML></p>	<p>On Check-out, the bill is automatically printed out on the predefined network printer. This setting is unaffected by the possibility of printing out the bill individually in Aastra Hospitality Manager.</p> <p>Enter here the IP network address of the PC where the Aastra 400 Print Spooler is installed.</p> <p>Enter here the port configured on the Aastra 400 Print Spooler.</p> <p>Select here the print format for the network printer.</p>
<i>Property Management System (PMS)</i>		
<ul style="list-style-type: none"> Activate PMS interface PMS link status PMS version PMS protocol version PMS interface driver version IP address Port FIAS room number Call charging posting method FIAS codepage 	<p><Yes / No></p> <p><Active / Inactive></p> <p><Version></p> <p><Version></p> <p><Version></p> <p><IP address></p> <p><Port></p> <p><Room number / Room phone call number / Room name></p> <p><Total amount / Number of pulses / Dialed numbers with call duration></p> <p><ISO_8859_1 / Codepage_850></p>	<p>The PMS interface is used to connect a PMS system via the FIAS (Fidelio Interface Application Specification) protocol. The interface can be switched on and off here.</p> <p>Indicates the current state of the link status</p> <p>Indicates the PMS software version</p> <p>Indicates the PMS protocol version</p> <p>Indicates the PMS interface driver version</p> <p>IP network address of the PMS interface</p> <p>Port of the PMS interface</p> <p>Choose here the entry to be used as FIAS room number.</p> <p>Select here which data should be posted to the PMS for the further processing of the call charges.</p> <p>Select the codepage used by the PMS. If the codepages do not match, individual characters may not be output correctly.</p>

Tab. 368 CM_2.6.2 Room: System configuration

Parameter	Parameter value	Remarks
• <i>Room Number</i>	<Number>	Number of the guest room. It may match the call number of the room phone, but does not have to.
• <i>Call number</i>	<Number>	Internal call number of the room phone. It may match the room number, but does not have to.
• <i>Floor</i>	<Number>	Floor where the guest room is located. This entry defines the vertical arrangement of the guest rooms in the view display of Aastra Hospitality Manager.
• <i>Room Name</i>	<No. - [Name]>	Name of the guest room
• <i>Description</i>	<No. - [Name]>	Free text field (optional entry)

Tab. 369 CM_2.6.3 Maintenance codes: System configuration

Parameter	Parameter value	Remarks
• <i>Maintenance code</i>	<Figure>	The table with the maintenance codes is set up here. Here each maintenance code is assigned a meaning.
• <i>Meaning</i>	<Text>	

9.9.6 Features in mode V1

The features in mode V1 are designed to implement a simple accommodation and hotel solution. They include:

- Check-in / check-out menu
- Barring of room-to-room traffic with the possibility of bypassing using a secret code
- The input of wake-up times
- Automatic exchange barring at check-out

Analogue terminals with integrated function keys or the digital phones with message display are suitable for use in hotel rooms (see also "[Message function](#)", [page 418](#)).

9.9.6.1 Configuration and operating concept

The configuration is carried out using the AMS Hotel Manager or the System Assistant on the Office 45. The *Hospitality mode* parameter in the AMS Hotel Manager must be configured to *V1*.

The functions are operated using the System Assistant on the Office 45.

If a Property Management System is connected, the functions can also be carried out via the external application.

9.9.6.2 Setting up rooms/phone booths

For each user the type of *connection* can be configured in the AMS Configuration Manager.

- *Standard* (operating or service numbers)
- *Room*
- *Phone booth*

The features for the *Room* and *Booth* configuration differ from those of the standard interface.

This configuration is used for differentiation purposes in the OCL (reports, counter readings, threshold values).

Tab. 370 Configuration possibilities depending on the connection type

	<i>Standard</i>	<i>Room</i>	<i>Phone booth</i>
Business and private calls	✓	private only	private only
Barring room-to-room traffic	1)	✓	✓
Operation via room menu	–	✓	✓
Activate message	✓	✓	✓
Answer message	✓	✓	✓
Activate wake-up orders	✓	✓	✓

1) Possible only via internal digit barring

9.9.6.3 Room-to-room traffic

If room-to-room traffic is enabled, guests have the possibility of telephoning directly to other rooms.

Traffic between rooms/phone booths can be configured with the following measures:

- General configuration as the basic setup for all rooms.
- Specific configuration per room port for room status *Occupied*.
If the room status is *Free*, the system automatically resets the default values.

The *room-to-room traffic* configuration can be modified by the System Assistant on Office 45, e.g. to allocate special privileges to travel groups.

Secret code

The secret code feature (*34) allows barred room-to-room traffic and internal digit barring to be bypassed. If *34 is barred in the internal digit barring, "secret code" cannot be activated. The room-to-room configuration applies exclusively.

The secret code allows key hotel management staff for example to make calls to otherwise barred users. If the secret code is disclosed to a group of guests, room-to-room traffic can also be enabled.

Note: This feature is not described in any of the operating instructions.

9.9.6.4 Room status

Each room is assigned *Free* or *Busy*. These room statuses can be assigned configurations individually. When the status changes, the following actions take place automatically:

Room status from *Free* to *Busy*:

(Log guest on)

- The name of the previous guest is deleted. (Only if under *Attendant - Hotel - Settings: Delete name generally* is configured).
- Call charge counter reading ICC is deleted.
- User is given exchange access.
- Call Forwarding, Call Forwarding on No Reply, wake-up orders, etc., are deleted.
- Room-to-room authorization is set to the default configured in the *Setup* menu. If no default is configured, the current *Room-to-room* setting is retained.

Room status from *Busy* to *Free*:

(Log guest off)

- User's exchange access is barred.
- Call Forwarding, Call Forwarding on No Reply, etc., are deleted.
- The individual room report containing all the call data is printed out if the option *Receipt* is set to *Yes* in the menu *Attendant - Hotel - Settings*.

The wake-up orders and the ICC data are not automatically deleted during log-off as the guest may well settle his bill in the evening but leave only during the night or the following morning.

9.9.6.5 Wake-up call

Unanswered wake-up calls are normally displayed at Reception with *Wake-up call refused*. This alarm can be switched off in the general hotel settings.

9.9.6.6 Phone booth

A hotel phone box allows guests to make external calls with charge recall and the hotel staff itself to make internal calls. It is also possible to pick up calls and to transfer calls (for instance pick up calls). This relieves the workload on the reception staff.

The Office 45 can be used as an operator console; the Aastra 1560 / Office 1560 as a PC operator console.

Example:

Setting up a phone booth:

1. User configuration for No. 45:
 - Extension: Phone booth
 - Exchange access: No
 - Internal digit barring: 9
 - External digit barring: 10 (or no digit barring)
2. Internal digit barring 9:
 - All barred
 - Enabled list:
 - 0 (exchange access)
 - *86 (call pick up)
 - R (control key)
 - 5 (internal numbers beginning with 5)
3. External digit barring 10: (as required)
All enabled
4. The following macro is configured on one of the free keys of the terminal from which the charge recall is to be activated (normally at reception):

Phone booth operation, variant 2

Guest user 45 contacts Reception because he wants to make a phone call.

```

I : Call from the phone booth no.45          07:45
I : Call to the phone booth no.45          07:46

-- Line key      1...5      _____o__
*3245
Enquiry call    DTMF      Park      Message
    
```

Fig. 241 Signalling on the operator console with variant 2 of phone booth operation

The guest in the phone box picks up the receiver within 2 minutes and obtains a dial tone. The line is signalled as "busy" on the operator console.

Operating sequence on the operator console:

- Press phone box key (*3245 configured)
- Press Enter key
- Press the End key

When the call in the phone box is completed the charge recall signal rings on the operator console and the call charge information is displayed in the same way as in variant 1 (possibly with a delay depending on the configuration).

Phone booth operation, variant 3

User 29, who does not have exchange access authorization, picks up the receiver and dials the operator's number (11). He asks for a trunk line and puts down the receiver.

```

I : Call from user 29                        07:46
I : Function key charge recall (*32)        07:47

-- Line key      1...5      _____o__
*3245
Enquiry call    DTMF      Park      Message
    
```

Fig. 242 Signalling on the operator console with variant 3 of phone booth operation

Operating sequence on the operator console:

- Press function key (*32 configured)
- Suffix dial 29 or wait 2 seconds
- Press the End key

As a call is signalled, the user in the phone box picks up the receiver, obtains a dial tone and dials.

When the call in the phone box is completed the charge recall signal rings on the operator console and the call charge information is displayed in the same way as in variant 1 or 2 (possibly with a delay depending on the configuration).

9.9.6.7 Property Management Systems (PMS)

The Ethernet interface (Port 1051) can be used to connect a PC to carry out functions in the communication server using command language. A special command set is available for communicating with the Property Management System. These commands can then be used to carry out user-specific polling operations (e.g. room status) and configurations (e.g. wake-up time). Therefore you need to set up a user account with an authorization profile in which the interface access *Office 45* is enabled.

For more detailed information on the mode, the command set, the connection possibilities and property management systems please go directly to open.interfaces@aastra.com



Tip:

The *User alarm* event message can be generated from any internal terminal using the command *77 [nnnn]. The parameter nnnn is optional and has a value range from 0000 to 9999. Together with a connected application various control and messaging functions can be implemented, e.g. minibar items to be replaced in a hotel room, etc.

9.10 Message and Alarm Systems

The system supports several message formats and message protocols for implementing messaging and alarm systems.

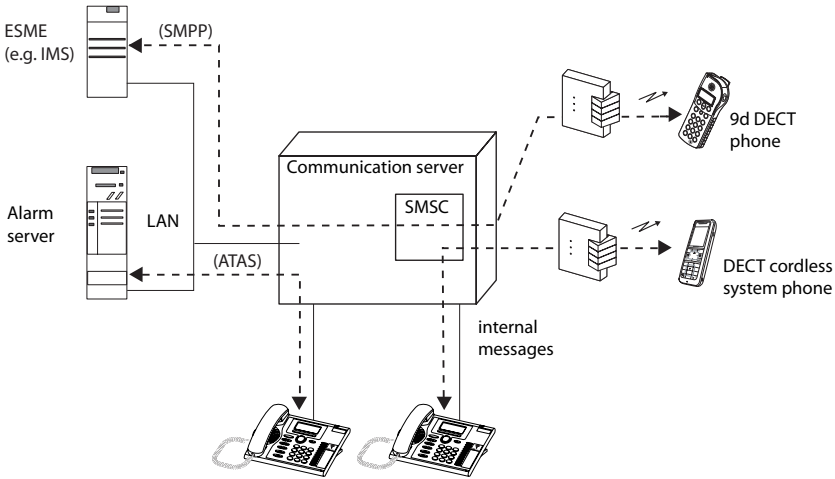

ESME (External Short Message Entity): External entity that processes short messages (SMS)
 SMPP (Short Message Point-to-Point Protocol): SMS Protocol

Fig. 243 Message and alarm systems

9. 10. 1 Internal messaging system for system phones

The internal messaging system for system phones allows users to exchange predefined or user-defined text messages between system phones. Text messages can also be sent to individual users or message groups.

The internal messaging system for system phones is licence-free (see also "[Sending and reading text messages](#)", page 416).

9. 10. 2 Expanded messaging system with 9d-DECT phones

With the expanded, licensed messaging system can be used to implement user-friendly messaging and alarm systems. The licence enables the use of the SMPP protocol and 9d cordless phones to be logged on as system phones. A wide range of alarm and message applications as well a cordless DECT phones can then be used from the Ascom Wireless Solutions product portfolio.

The communication server is capable of communicating with up to 10 different ESMEs. Examples of ESMEs include the IMS (Integrated Message Server) and Mailgate (both Ascom Wireless Solutions products).

Aastra 400 ensures the connections between the IMS and the 9d phones. 9d phones do not register with under the GAP standard but as system phones. The

IMS communicates with the communication server via the LAN interface. The SMPP protocol is used for this purpose.

A web-based configuration is loaded into the browser via the AMS Shell for the configuration of the ESME.

9. 10. 3 External messaging and alarm systems

External messages in Short Message format (SM) are signalled to the PBX by an SM server (e.g. IMS: Integrated Message Server) via the Ethernet interface using the SMPP protocol logged in the communication server.

The ATAS protocol is used for the external alarms of an alarm server. The alarms are routed directly to the corresponding destination terminal. Storage locations for alarms are available for each terminal.

External messages and external alarms are handled differently in the communication server.

9. 10. 3. 1 Message handling

External and internal messages are first sent to the SMSC (Short Message Service Centre), which then forwards the messages to the corresponding destination phone. The SMSC is a software package integrated in the communication server that is responsible for the flow of messages within the communication server.

Up to 16 messages can be buffered for each phone. Undeliverable messages (e.g. phone memory full) are buffered in the SMSC (up to 400 messages). Overflow of the phone memory is signalled accordingly on the display of the system phone. A new attempt at delivering buffered internal messages is made after a configurable resend period. The messages are definitively deleted once the validity period, which is also configurable, has expired. With external messages the validity period is usually also transmitted. If not, the internal setting is also used. The resend period for external messages is always one quarter of the validity period.

AMS can be used to delete all pending messages or messages that are more than three days old on all system phone (see [Tab. 252](#)).

The SMSC is configured using the AMS Configuration Manager:

Tab. 371 SMSC settings

Parameter	Remarks
<i>SMSC port</i>	The address is used for incoming messages of an external message server.
<i>Retransmission period</i>	Applies only to internal messages. For external messages the resend period is always one quarter of the validity period.
<i>Validity period</i>	It is only used for external messages if a validity period was not transmitted along with the message.

If the external message server is capable of handling short messages (SMS), then it is an ESME (External Short Message Entity). An ESME always communicates with the communication server via LAN. The communication settings between the SMSC and the ESME can be configured in AMS:

Tab. 372 ESME settings

Parameter	Remarks
<i>IP address, Port</i>	IP address and port of the ESME for outgoing messages
<i>Type</i>	The ESME type is specified here (SM application, SM gateway or SM Service Centre).
<i>Encryption</i>	This parameter must match the setting on the external message server.
<i>URL of ESME configuration</i>	With the aid of this address a web-based configuration tool of an ESME can be retrieved directly via the AMS Shell.
<i>Default ESME</i>	Messages without a destination address are sent to the default ESME.
<i>Password</i>	The password is checked every time a connection is set up between SMSC and ESME (minimum length = 4).
<i>Response time</i>	Max. amount of time the SMSC waits for an answer from the ESME [0...5 minutes]

Besides these settings the authorization to send short messages to an ESME can be enabled or disabled for each user:

Send SMS = Yes / No (default setting = *Yes*)

A web-based configuration is loaded into the browser via the AMS Shell for the configuration of the ESME.

The use of the SMPP protocol to integrate an SMS server is subject to a licence.



Warning:

In the case of applications designed for emergency calls and personal protection such as fire alarm systems, nurse light paging systems, alarm systems against attacks or hold-ups, etc., text messages may only be used to complement certified alarm systems. Text message alarming is only compatible with emergency operation if the communication server and the external alarm source are equipped with a UPS.

9. 10. 3. 2 Alarm handling

External alarms from an alarm server are not handled by the SMSC but sent directly to the corresponding destination phone. No more alarms can be sent to the corresponding phone if the storage location is full. The alarm server is responsible for ensuring that alarms are delivered.

Other Properties and System Limits:

- Alarms take priority over messages.
- Max. length of alarm message texts is 160 characters.
- A maximum of 16 alarms can be stored for each user. No more alarms can be delivered after that.
- Alarms are always routed to the destination defined in the send command; Call Forwarding Unconditional and Call Forwarding on No Reply operations have no effect.
- Several alarm sources can be connected to each communication server.

9. 10. 3. 3 Alarm trigger with ATAS

The ATAS protocol provides convenient possibilities for display on the system phones (Fox menu) and allows an alarm to be triggered using the Redkey (see "Function Redkey", page 516). The connection is also monitored, and the connection set-up is password-protected. To use the ATAS interface you need to set up a user account with an authorization profile in which the interface access *ATAS* is enabled. An ATAS licence is required for enabling the protocol.

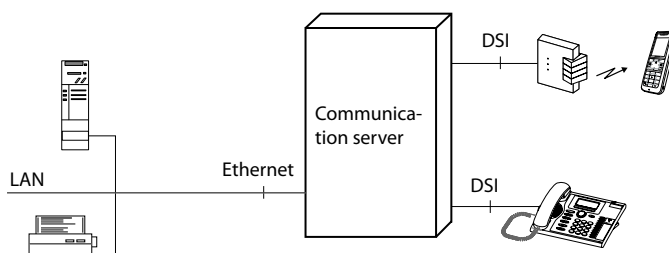

Fig. 244 Connection via Ethernet

Function Redkey

On each system phone one or more function keys can be configured as Redkeys. Depending on the application an alarm can then be triggered, a heating system switched on, a process controlled, etc., with the aid of the ATAS protocol on an ATAS server. The message sent contains the user number and additional parameters (max. 32 characters/digits).

- The configuration is set for each phone and can only be made via AMS.
- The function can be stored on any configurable keys of the system phones.
- Several keys on each phone can be configured as Redkeys.
- The Redkey function can be triggered regardless of the operating state (idle, dialling, call, ringing) of the system phone.
- If the Redkey is configured on a function key, a distinction can be made between single and double click due to a different assignment of the number memories.
- Once a Redkey has been configured, it can only be reconfigured via AMS.
- The application on the ATAS server can acknowledge that a function has been triggered by a Redkey by sending a message to the phone's display (with or without a prompt to acknowledge the message).

Redkey as function code

To be able to perform the Redkey function also on third-party terminals (analogue terminals, SIP terminals etc.), a */# function code is available. Possible applications are analogue terminals in retirement homes, door intercom systems, lift telephones etc.

Tab. 373 Trigger Redkey function: Function

Function	Function code	Note
Trigger Redkey function	*73 <Parameter> #	The parameter can contain a maximum of 28 digits.

Hotkey modes for DECT cordless phones

On DECT cordless phones the Redkey function can be configured on the Hotkey. To ensure that again only one keystroke is needed to trigger the function, the Hotkey can be limited to one storage location (instead of 6) by using the parameter *1Hotkey only = Yes* in the terminal settings. (A long click is required if the keypad lock is activated.) This setting can be configured with AMS for each DECT cordless phone.

Hotkey mode

On the Office 160Safeguard/ATEX and Aastra 630d the Redkey function is available on the SOS key on the upper side of the phone. With the parameter *1 Hotkey only = Yes* the Redkey function is triggered with the automatic alarm triggers (Man-down, no movement or escape alarm) as well as the SOS button and the hotkey. The following two trigger types can be differentiated by configuring different parameters:

- Triggering by hotkey (on the side of the phone):
--> The parameter in the first number memory is added to the ATAS message.
- Manual trigger using the SOS key (on the upper side of the phone) or automatically using the man-down, no-movement or escape alarm:
--> The parameter in the first number memory is added to the ATAS message.

Both trigger types are capable of triggering dialling or executing a function.

It is irrelevant whether a single, double or long click is carried out. (Exception: If the keypad lock is activated, a long key is required for triggering using the hotkey.)

The accidental triggering of a function by the hotkey can be avoided by assigning the number memories differently and their evaluation (e. g. on the ATAS server).

The configuration *1 hotkey only = No* provides six function or number keys on the hotkey in the usual way. In this case pressing the alarm button corresponds to pressing the hotkey.

9. 10. 3. 4 Alarm trigger with ATAS/ATASpro

Alarm server mode

On the Office 160Safeguard/ATEX and the Aastra 630d a special *Alarm server mode* is available for the connection to an external alarm system. In this mode different ATAS alarm messages are sent for each type of alarm trigger:

- Manual trigger with the SOS key
- Automatic trigger using man-down alarm: *Man-down alarm*
- Automatic trigger using no-movement alarm: *No-movement alarm*
- Combined automatic trigger using man-down and no-movement alarm
- Aastra 630d only: Automatic trigger using escape alarm: *Escape alarm*

This means the alarm server is able to respond differently to the alarms it receives, depending on the type of trigger.

This functionality (as well as other features such as DECT locating) is available only with the ATASpro protocol. The *ATAS Interface* and *ATASpro Interface* licences are also required.

The hotkey on the side of the phone can be freely configured with phone number and/or functions and is completely independent of the other alarm triggering functions. It can also be configured as *1 hotkey only*. The Redkey function can also be stored on this key, which then generates other ATAS messages.

The following also applies for Aastra 630d:

- The alarm server is capable of alarming via the phone using 9 melodies. Of these, one melody is *Pager call* and one *Vibra call*.
- The alarm server is capable of overriding the locally set alarm melodies. This also applies to *Vibra call* and *Tone ringing suppressed*.
- The alarm server can use a special call alert to disconnect a call in progress and raise the alarm using a rising default alarm tone.
- The alarm server can give the alarm a hidden function which is triggered when the recipient of the alarm presses the Hook key (e. g. call to a number or setting up a conference).



Note:

The phone acts as an alarm phone and is therefore only one component within an entire alarm concept. The response to a triggered alarm depends on the configuration and design of the alarm concept, and the alarm functions must always be configured within the context of the overall alarm concept.



See also:

The operation and configuration possibilities for alarming the Office 160Safeguard/ATEX and the Aastra 630d such as alarm delay, detection time and alarm signalling are described in detail in the relevant user's guides.

9. 10. 3. 5 Interface descriptions

The ATAS and ATASpro protocols can be disclosed to interested manufacturers of messaging, monitoring and alarm equipment on request. Please go directly to "open.interfaces@aastra.com".

10 Features Overview

Here is provided an alphabetical overview in table form of the features that can be operated on the terminals.

Tab. 374 Legend used in the table of features

	Foxkey-operated feature (in part also using */# function code)
M	Menu key-operated feature (in part also using */# function code)
ISDN	Feature available as a standard ISDN service (ETSI signalling) and therefore menu-operated on commercially available ISDN terminals (also via */# function codes)
Function code	Feature actuated only by using a */# function code. For pulse dialling phones without the * key, a substitute * can be defined in the numbering plan (e.g. "9")
R	Feature actuated using the control key
✓	Feature available on the terminal
TM	Feature supported by the communication server. Its availability depends on the terminal
Digit	Digit suffix dialling (DTMF mode not activated)
–	Feature not supported on this terminal







See also

The SIP terminals of the Aastra 6700i product series and other SIP terminals of Aastra Telecom Schweiz AG and outside manufacturers are included in the features overview of the "SIP in Aastra 400 and Aastra IntelliGate" System Manual.

Tab. 375 Features overview (in alphabetical order)











Features	Integrated mobile phones ¹⁾	Aastra 6700i SIP series	Other SIP terminals	Aastra 1560 Office 1560 Aastra 2380ip	Office series 25,35,45 Aastra 5300 series	Office 10	Office 135 Office 160 Aastra 600d series	ISDN terminals	Analogue terminals (DTMF)
Two-company configuration	–	–	–	–	✓ ²⁾	–	–	–	–
Exchange Access									
• Business (example CH)	0	0	0	0	0	0	0	0	0
• Least Cost Routing	✓	✓	✓	✓	✓	✓	✓	✓	✓
• LCR (fallback)	*90	*90	*90	*90	*90	*90	*90	*90	*90
• Private (example CH)	10	10	10	10	10	10	10	10	10
• With cost centre nn	13nn	13nn	13nn	13nn	13nn	13nn	13nn	13nn	13nn
• With charge recall	–	–	–	*32 SC No.	*32 SC No.	–	*32 SC No.	*32 SC No.	–
• Route selection, targeted (n depends on the system)	170 to n	170 to n	170 to n	170 to n	170 to n	170 to n	170 to n	170 to n	170 to n
Call waiting									
• Activate	*** *43 oder ***6	–	–			*43 / 6		*43 / 6	R*43 / R6
• Reject	***0	–	–			End		ISDN	R0
• Answer with hold	***2	–	–					ISDN	R2
• Answer without hold	***1	–	–			1		ISDN	R1
• Answer, with conference	***3	–	–	3	3	3	3	ISDN	R3
• Protect against	*04	–	–	*04	*04	*04	*04	*04	*04
• Allow to own set	#04	–	–	#04	#04	#04	#04	#04	#04
Reject call	–	✓	TM			–		ISDN	–

Features	Integrated mobile phones ¹⁾	Aastra 6700i SIP series	Other SIP terminals	Aastra 1560 Office 1560 Aastra 2380ip	Office series 25,35,45 Aastra 5300 series	Office 10	Office 135 Office 160 Aastra 600d series	ISDN terminals	Analogue terminals (DTMF)
Call pick-up (x = SC No. / UG No. / CDE No.)	*86 x	*86 x	*86 x			*86 x		*86 x	*86 x
Deflect call during the ringing phase (CD)	-	-	-			-		TM	-
Display caller's name (CNIP / CONP)	TM	✓	TM	✓	✓	-	✓	ISDN	-
Display caller's number (CLIP / COLP)	TM	✓	TM	✓	✓	-	✓	ISDN	-
List of callers	TM	✓	TM			-		TM	-
Call Forwarding Unconditional (CFU)									
• Activate	*21 destination No.	M	*21 destination No.			*21 destination No.		*21 destination No.	*21 destination No.
• Activate to last configured Dest. No.	*21#	M	*21#			*21#		*21#	*21#
• Clear	#21	M	#21			#21		#21	#21
• Activate to preconfigured Dest. No.	*22	*22	*22	*22	*22	*22	*22	*22	*22
• Clear on preconfigured Dest. No.	#22	#22	#22			#22		#22	#22
• Activate on general bell with coded ringing	*28	*28	*28			*28		*28	*28
• Clear to general bell with coded ringing	#28	#28	#28			#28		#28	#28
• Activate to standard text	*24 text No. param.#	*24 text No. param.#	*24 text No. param.#			*24 text No. param.#		*24 text No. param.#	*24 text No. param.#
• Clear to standard text	#24	#24	#24			#24		#24	#24

Features	Integrated mobile phones ¹⁾	Aastra 6700i SIP series	Other SIP terminals	Aastra 1560 Office 1560 Aastra 2380ip	Office series 25,35,45 Aastra 5300 series	Office 10	Office 135 Office 160 Aastra 600d series	ISDN terminals	Analogue terminals (DTMF)
<ul style="list-style-type: none"> Protect against Allow to own set 	*02 #02	*02 #02	*02 #02	*02 #02	*02 #02	*02 #02	*02 #02	*02 #02	*02 #02
Do not disturb									
<ul style="list-style-type: none"> Activate Clear 	*26 #26	*26 #26	*26 #26	 	 or *26  or #26	*26 #26	*26 #26	*26 #26	*26 #26
Announcement service									
<ul style="list-style-type: none"> Recording a welcome announcement with a phone Recording a welcome announcement with audio equipment Check recording Delete recording Activate welcome announcement Deactivate welcome announcement 	*911 xx[*nn] # *921 xx[*nn] # *#911 xx [*nn] # or *#921 xx [*nn] # #911 xx [*nn] # or #921 xx [*nn] # *931 yy[*nn] # #931 yy [*nn] #	*911 xx[*nn] # *921 xx[*nn] # *#911 xx [*nn] # or *#921 xx [*nn] # #911 xx [*nn] # or #921 xx [*nn] # *931 yy[*nn] # #931 yy [*nn] #	*911 xx[*nn] # *921 xx[*nn] # *#911 xx [*nn] # or *#921 xx [*nn] # #911 xx [*nn] # or #921 xx [*nn] # *931 yy[*nn] # #931 yy [*nn] #	*911 xx[*nn] # *921 xx[*nn] # *#911 xx [*nn] # or *#921 xx [*nn] # #911 xx [*nn] # or #921 xx [*nn] # *931 yy[*nn] # #931 yy [*nn] #	*911 xx[*nn] # *921 xx[*nn] # *#911 xx [*nn] # or *#921 xx [*nn] # #911 xx [*nn] # or #921 xx [*nn] # *931 yy[*nn] # #931 yy [*nn] #	*911 xx[*nn] # *921 xx[*nn] # *#911 xx [*nn] # or *#921 xx [*nn] # #911 xx [*nn] # or #921 xx [*nn] # *931 yy[*nn] # #931 yy [*nn] #	*911 xx[*nn] # *921 xx[*nn] # *#911 xx [*nn] # or *#921 xx [*nn] # #911 xx [*nn] # or #921 xx [*nn] # *931 yy[*nn] # #931 yy [*nn] #	*911 xx[*nn] # *921 xx[*nn] # *#911 xx [*nn] # or *#921 xx [*nn] # #911 xx [*nn] # or #921 xx [*nn] # *931 yy[*nn] # #931 yy [*nn] #	*911 xx[*nn] # *921 xx[*nn] # *#911 xx [*nn] # or *#921 xx [*nn] # #911 xx [*nn] # or #921 xx [*nn] # *931 yy[*nn] # #931 yy [*nn] #
xx = file number <10...29> yy = welcome announcement <01...20> for Aastra 415/430 or <01...50> for Aastra 470 nn = node No. (optional)									
Presence									

Features	Integrated mobile phones ¹⁾	Aastra 6700i SIP series	Other SIP terminals	Aastra 1560 Office 1560 Aastra 2380ip	Office series 25,35,45 Aastra 5300 series	Office 10	Office 135 Office 160 Aastra 600d series	ISDN terminals	Analogue terminals (DTMF)
• Activate presence status	*27 x hhmm ddmm #	M	*27 x hhmm ddmm #			*27 x hhmm ddmm #		*27 x hhmm ddmm #	*27 x hhmm ddmm #
• Activate presence status (without date)	*27 x hhmm #	M	*27 x hhmm #			*27 x hhmm #		*27 x hhmm #	*27 x hhmm #
• Activate presence status (without time/date)	*27 #	M	*27 #			*27 #		*27 #	*27 #
• Deactivate presence status	#27 or *27 0 #	M	#27 or *27 0 #			#27 or *27 0 #		#27 or *27 0 #	#27 or *27 0 #
x = profile number 0...4: 0 = Available (default), 1 = Absent, 2 = Meeting, 3 = Busy, 4 = Not available hhmm = time in 24-hour format, ddmm = date indication (day-month)									
Intrusion									
• Activate	*** *44 oder ***7	-	-			*44	*44	-	R7 or R*44
• Reject	***0	-	-			0		-	R0
• Answer with hold	***2	-	-			2		-	R2
• Answer without hold	***1	-	-			1		-	R1
• Answer with conference	***3	-	-	3	3	3	3	-	R3
• Protect against	*04	-	-	*04	*04	*04	*04	*04	*04
• Allow to own set	#04	-	-	#04	#04	#04	#04	#04	#04
Call Forwarding if Busy (CFB)									
• Activate	*67 destination No.	M	*67 destination No.			*67 destination No.		ISDN	*67 destination No.
• Activate to last configured Dest. No.	*67#	M	*67#			*67#		*67#	*67#

Features	Integrated mobile phones ¹⁾	Aastra 6700i SIP series	Other SIP terminals	Aastra 1560 Office 1560 Aastra 2380ip	Office series 25,35,45 Aastra 5300 series	Office 10	Office 135 Office 160 Aastra 600d series	ISDN terminals	Analogue terminals (DTMF)
• Clear	#67	M	#67			#67		#67	#67
Automatic software update	-	✓	-	✓	✓ ³⁾	-	✓	-	-
Automated configuration	✓	✓	-	✓	✓	✓	✓	-	-
Accommodation/Hotel (mode V2 only)									
• Enter cleaning status	*52 x #	*52 x #	*52 x #	*52 x #	*52 x #	*52 x #	*52 x #	*52 x #	*52 x #
• Enter cleaning status on third-party phone	*52x*Room No. #	*52x*Room No. #	*52x*Room No. #	*52x*Room No. #	*52x*Room No. #	*52x*Room No. #	*52x*Room No. #	*52x*Room No. #	*52x*Room No. #
x = cleaning status: 1 = Not cleaned, 2 = Cleaned, 3 = Checked									
• Enter maintenance notice	*53 Code #	*53 Code #	*53 Code #	*53 Code #	*53 Code #	*53 Code #	*53 Code #	*53 Code #	*53 Code #
• Delete all maintenance notices for the room	#53 #	#53 #	#53 #	#53 #	#53 #	#53 #	#53 #	#53 #	#53 #
• Enter maintenance notice on third-party phone	*53 Code * Room No. #	*53 Code * Room No. #	*53 Code * Room No. #	*53 Code * Room No. #	*53 Code * Room No. #	*53 Code * Room No. #	*53 Code * Room No. #	*53 Code * Room No. #	*53 Code * Room No. #
• Delete all maintenance notices for the room on third-party phone	#53 Room No. #	#53 Room No. #	#53 Room No. #	#53 Room No. #	#53 Room No. #	#53 Room No. #	#53 Room No. #	#53 Room No. #	#53 Room No. #
• Enter one missing item (minibar)	*51 Art. No. #	*51 Art. No. #	*51 Art. No. #	*51 Art. No. #	*51 Art. No. #	*51 Art. No. #	*51 Art. No. #	*51 Art. No. #	*51 Art. No. #
• Enter several missing items (minibar)	*51 Art. No. * Number #	*51 Art. No. * Number #	*51 Art. No. * Number #	*51 Art. No. * Number #	*51 Art. No. * Number #	*51 Art. No. * Number #	*51 Art. No. * Number #	*51 Art. No. * Number #	*51 Art. No. * Number #

Features	Integrated mobile phones ¹⁾	Aastra 6700i SIP series	Other SIP terminals	Aastra 1560 Office 1560 Aastra 2380ip	Office series 25,35,45 Aastra 5300 series	Office 10	Office 135 Office 160 Aastra 600d series	ISDN terminals	Analogue terminals (DTMF)
<ul style="list-style-type: none"> Enter one missing item (minibar) on third-party phone Enter several missing items (minibar) on third-party phone Charge amount to guest room Charge amount to guest room using third-party phone 	*51 Art. No. * 1 * Room No. #	*51 Art. No. * 1 * Room No. #	*51 Art. No. * 1 * Room No. #	*51 Art. No. * 1 * Room No. #	*51 Art. No. * 1 * Room No. #	*51 Art. No. * 1 * Room No. #	*51 Art. No. * 1 * Room No. #	*51 Art. No. * 1 * Room No. #	*51 Art. No. * 1 * Room No. #
	*51 Art. No. * Quantity * Room No. #	*51 Art. No. * Quantity * Room No. #	*51 Art. No. * Quantity * Room No. #	*51 Art. No. * Quantity * Room No. #	*51 Art. No. * Quantity * Room No. #	*51 Art. No. * Quantity * Room No. #	*51 Art. No. * Quantity * Room No. #	*51 Art. No. * Quantity * Room No. #	*51 Art. No. * Quantity * Room No. #
	*54 Art. No. * Amount #	*54 Art. No. * Amount #	*54 Art. No. * Amount #	*54 Art. No. * Amount #	*54 Art. No. * Amount #	*54 Art. No. * Amount #	*54 Art. No. * Amount #	*54 Art. No. * Amount #	*54 Art. No. * Amount #
	*54 Art. No. * Amount * Room No. #	*54 Art. No. * Amount * Room No. #	*54 Art. No. * Amount * Room No. #	*54 Art. No. * Amount * Room No. #	*54 Art. No. * Amount * Room No. #	*54 Art. No. * Amount * Room No. #	*54 Art. No. * Amount * Room No. #	*54 Art. No. * Amount * Room No. #	*54 Art. No. * Amount * Room No. #
Busy lamp field	-	✓	-	✓	✓ ²⁾	-	-	-	-
Call deflection (CD)	see "Deflect call during the ringing phase (CD)"								
Coded ringing on generalcall									
<ul style="list-style-type: none"> Activate in prefix dialling Activate in suffix dialling Answer 	*81 SC No. *** *81 oder ***8 *82	*81 SC No. - *82	*81 SC No. - *82	  	  	*81 SC No. *81 / 8 *82	  	*81 SC No. *81 / 8 *82	*81 SC No. R8 or R*81 *82
Discreet ringing									
<ul style="list-style-type: none"> Activate Deactivate 	-	-	-	✓	✓	-	 	-	-
DTMF dialling	✓	✓	✓	✓	✓	✓	✓	✓	✓
Announcement									















Features	Integrated mobile phones ¹⁾	Aastra 6700i SIP series	Other SIP terminals	Aastra 1560 Office 1560 Aastra 2380ip	Office series 25,35,45 Aastra 5300 series	Office 10	Office 135 Office 160 Aastra 600d series	ISDN terminals	Analogue terminals (DTMF)
• Answer within the group	–	–	–			–		–	–
• Answer outside the group	*89	*89	*89	*89	*89	*89	*89	*89	*89
• Initiate on a user	*7998 SC No.	*7998 SC No.	*7998 SC No.			*7998 SC No.		*7998 SC No.	*7998 SC No.
• Initiate in suffix dialling	–	–	–			–		–	–
• Initiate to a group	*79 Gr. No.	*79 Gr. No.	*79 Gr. No.			*79 Gr. No.		*79 Gr. No.	*79 Gr. No.
Generate an event message (triggering a user alarm) nnnn = 0000...9999	*77 nnnn	*77 nnnn	*77 nnnn	*77 nnnn	*77 nnnn	*77 nnnn	*77 nnnn	*77 nnnn	*77 nnnn
Fast Take	see "Acceptance of a call connection or a call without preparation (Fast Take)"								
Remote maintenance / configuration									
• Enable/bar a one-off remote maintenance	*754 / #754	*754 / #754	*754 / #754	*754 / #754	*754 / #754	*754 / #754	*754 / #754	*754 / #754	*754 / #754
• Enable/bar a repeated remote maintenance access	*753 / #753	*753 / #753	*753 / #753	*753 / #753	*753 / #753	*753 / #753	*753 / #753	*753 / #753	*753 / #753
Follow me									
• Activate	*23 SC No.	*23 SC No.	*23 SC No.	*23 SC No.	*23 SC No.	*23 SC No.	*23 SC No.	*23 SC No.	*23 SC No.
• Clear	#23	#23	#23	#23	#23	#23	#23	#23	#23
Function keys configurable via AMS	–	✓	–	✓	✓	✓	✓	–	–
Call charges									
• Call charge transfer	✓	✓	✓	✓	✓	✓	✓	✓	✓













Features	Integrated mobile phones ¹⁾	Aastra 6700i SIP series	Other SIP terminals	Aastra 1560 Office 1560 Aastra 2380ip	Office series 25,35,45 Aastra 5300 series	Office 10	Office 135 Office 160 Aastra 600d series	ISDN terminals	Analogue terminals (DTMF)
<ul style="list-style-type: none"> Transfer current call to another cost centre Individual charge counting (ICC) Charge recall 	*** *78 CC No. ✓ –	– ✓ –	– ✓ –	*78 CC No. ✓ *32 SC No.	*78 CC No. ✓ *32 SC No.	*78 CC No. ✓ –	*78 CC No. ✓ *32 SC No.	*78 CC No. ✓ *32 SC No.	*78 CC No. ✓ –
Call charge display									
<ul style="list-style-type: none"> for outgoing exchange calls for switched exchange calls 	– –	– –	– –	✓ ✓	✓ ✓	– –	✓ ✓	ISDN ISDN	– –
Duplex mode	see "Announcement"								
Secret code (disable room-to-room barring)	*34	*34	*34	*34	*34	*34	*34	*34	*34
Making calls with your own settings on a third-party phone									
<ul style="list-style-type: none"> Business calls Private calls 	#36 SC No. PIN #46 SC No. PIN	#36 SC No. PIN #46 SC No. PIN	#36 SC No. PIN #46 SC No. PIN	#36 SC No. PIN #46 SC No. PIN	#36 SC No. PIN #46 SC No. PIN	#36 SC No. PIN #46 SC No. PIN	#36 SC No. PIN #46 SC No. PIN	#36 SC No. PIN #46 SC No. PIN	#36 SC No. PIN #46 SC No. PIN
Call transfer									
<ul style="list-style-type: none"> after enquiry without enquiry Explicit call transfer (ECT) 	✓ ✓ –	✓ ✓ –	TM TM –	✓ ✓ –	✓ ✓ –	✓ ✓ –	✓ ✓ –	ISDN ISDN ISDN	✓ ✓ ✓





Features	Integrated mobile phones ¹⁾	Aastra 6700i SIP series	Other SIP terminals	Aastra 1560 Office 1560 Aastra 2380ip	Office series 25,35,45 Aastra 5300 series	Office 10	Office 135 Office 160 Aastra 600d series	ISDN terminals	Analogue terminals (DTMF)
Call take back from connection	see "Acceptance of a call connection or a call without preparation (Fast Take)"								
Home alone • Activate • Clear	*49 UG No. #49 UG No.	*49 UG No. #49 UG No.	*49 UG No. #49 UG No.	*49 UG No. #49 UG No.	*49 UG No. #49 UG No.	*49 UG No. #49 UG No.	*49 UG No. #49 UG No.	*49 UG No. #49 UG No.	*49 UG No. #49 UG No.
Conference • Set up (from connection) • Set up (variable) • Exclude internal conference participants • set up (preconfigured)	***3 *71 SC No.1 * up to SC No.5 # *** #71 *70 conf. No.	✓ *71 SC No.1 * up to SC No.5 # – *70 conf. No.	TM *71 SC No.1 * up to SC No.5 # – *70 conf. No.	 *71 SC No.1 * up to SC No.5 # #71 *70 conf. No.	 *71 SC No.1 * up to SC No.5 # #71 *70 conf. No.	 *71 SC No.1 * up to SC No.5 # #71 *70 conf. No.	 *71 SC No.1 * up to SC No.5 # #71 *70 conf. No.	ISDN *71 SC No.1 * up to SC No.5 # #71 *70 conf. No.	R3 *71 SC No.1 * up to SC No.5 # R#71 *70 conf. No.
Delete configuration (activated, personal functions deactivated)	*00 or #00	*00 or #00	*00 or #00	*00 or #00	*00 or #00	*00 or #00	*00 or #00	*00 or #00	*00 or #00
Allocate cost centre before the call	see "Exchange Access"								
Transfer current call to a different cost centre	see "Call charges"								
Abbreviated dialling numbers, throughout the system	✓	✓	✓	✓	✓	✓	✓	✓	✓
Remote control features	*06 SC No. LM Proc.	*06 SC No. LM Proc.	*06 SC No. LM Proc.	*06 SC No. LM Proc.	*06 SC No. LM Proc.	*06 SC No. LM Proc.	*06 SC No. LM Proc.	*06 SC No. LM Proc.	*06 SC No. LM Proc.
Brokering									













Features	Integrated mobile phones ¹⁾	Aastra 6700i SIP series	Other SIP terminals	Aastra 1560 Office 1560 Aastra 2380ip	Office series 25,35,45 Aastra 5300 series	Office 10	Office 135 Office 160 Aastra 600d series	ISDN terminals	Analogue terminals (DTMF)
<ul style="list-style-type: none"> in enquiry with line key 	<p>***2</p> <p>–</p>	<p>✓</p> <p>✓</p>	<p>TM</p> <p>TM</p>	<p></p> <p>✓</p>	<p></p> <p>✓³⁾</p>	<p></p> <p>–</p>	<p></p> <p>–</p>	<p>ISDN</p> <p>–</p>	<p>R2</p> <p>–</p>
MESSAGE LED									
<ul style="list-style-type: none"> Activate (prefix dialling) Activate (suffix dialling) Answer delete (on the destination phone) clear (on the executing phone) 	<p>*38 SC No.</p> <p>*** *38</p> <p>–</p> <p>–</p> <p>#38 SC No.</p>	<p>*38 SC No.</p> <p>–</p> <p>–</p> <p>–</p> <p>#38 SC No.</p>	<p>*38 SC No.</p> <p>–</p> <p>–</p> <p>–</p> <p>#38 SC No.</p>	<p>*38 SC No.</p> <p>–</p> <p></p> <p></p> <p>#38 SC No.</p>	<p>*38 SC No.</p> <p>–</p> <p></p> <p></p> <p>#38 SC No.</p>	<p>*38 SC No.</p> <p>–</p> <p>*#38</p> <p>#38#</p> <p>#38 SC No.</p>	<p>*38 SC No.</p> <p>–</p> <p></p> <p></p> <p>#38 SC No.</p>	<p>*38 SC No.</p> <p>–</p> <p>–</p> <p>–</p> <p>–</p>	<p>*38 SC No.</p> <p>R*38</p> <p>–</p> <p>–</p> <p>#38 SC No.</p>
Music on hold									
<ul style="list-style-type: none"> Recording with the phone Record with audio device Check recording Delete recording 	<p>*914 [*nn] #</p> <p>*924 [*nn] #</p> <p>*#914 [*nn] # or *#924 [*nn] #</p> <p>#914 [*nn] # or #924[*nn] #</p>	<p>*914 [*nn] #</p> <p>*924 [*nn] #</p> <p>*#914 [*nn] # or *#924 [*nn] #</p> <p>#914 [*nn] # or #924[*nn] #</p>	<p>*914 [*nn] #</p> <p>*924 [*nn] #</p> <p>*#914 [*nn] # or *#924 [*nn] #</p> <p>#914 [*nn] # or #924[*nn] #</p>	<p>*914 [*nn] #</p> <p>*924 [*nn] #</p> <p>*#914 [*nn] # or *#924 [*nn] #</p> <p>#914 [*nn] # or #924[*nn] #</p>	<p>*914 [*nn] #</p> <p>*924 [*nn] #</p> <p>*#914 [*nn] # or *#924 [*nn] #</p> <p>#914 [*nn] # or #924[*nn] #</p>	<p>*914 [*nn] #</p> <p>*924 [*nn] #</p> <p>*#914 [*nn] # or *#924 [*nn] #</p> <p>#914 [*nn] # or #924[*nn] #</p>	<p>*914 [*nn] #</p> <p>*924 [*nn] #</p> <p>*#914 [*nn] # or *#924 [*nn] #</p> <p>#914 [*nn] # or #924[*nn] #</p>	<p>*914 [*nn] #</p> <p>*924 [*nn] #</p> <p>*#914 [*nn] # or *#924 [*nn] #</p> <p>#914 [*nn] # or #924[*nn] #</p>	<p>*914 [*nn] #</p> <p>*924 [*nn] #</p> <p>*#914 [*nn] # or *#924 [*nn] #</p> <p>#914 [*nn] # or #924[*nn] #</p>
nn = node number (optional)									
Leave message									
<ul style="list-style-type: none"> Standard Own 	<p>*24 text No. param.#</p> <p>–</p>	<p>*24 text No. param.#</p> <p>–</p>	<p>*24 text No. param.#</p> <p>–</p>	<p></p> <p>✓</p>	<p></p> <p>✓</p>	<p>*24 text No. param.#</p> <p>–</p>	<p></p> <p>✓</p>	<p>*24 text No. param.#</p> <p>–</p>	<p>*24 text No. param.#</p> <p>–</p>

Features	Integrated mobile phones ¹⁾	Aastra 6700i SIP series	Other SIP terminals	Aastra 1560 Office 1560 Aastra 2380ip	Office series 25,35,45 Aastra 5300 series	Office 10	Office 135 Office 160 Aastra 600d series	ISDN terminals	Analogue terminals (DTMF)
• Clear / deactivate	#24	#24	#24			#24		#24	#24
Dialling by name	–	M	–	✓	✓	–	✓	–	–
Emergency / priority exchange seizure	✓	✓	✓	✓	✓	✓	✓	✓	✓
Emergency number	✓	✓	✓	✓	✓	✓	✓	✓	✓
Park									
• with line key	–	–	–	✓	✓ ³⁾	–	–	–	–
• with park key (local)	–	–	–			–		–	–
• Central parking	*** *76	–	–	*76	*76	*76	*76	*76	R*76
• Connect with centrally parked user	#76	#76	#76	#76	#76	#76	#76	#76	#76
Personal call routing									
• Activate	*45 x	*45 x	*45 x	*45 x	*45 x	*45 x	*45 x	*45 x	*45 x
• Deactivate	#45	#45	#45	#45	#45	#45	#45	#45	#45
x = call routing [1...5]									
Change PIN x = old PIN y = new PIN	*47 x * y * y #	*47 x * y * y #	*47 x * y * y #	*47 x * y * y #		*47 x * y * y #		*47 x * y * y #	*47 x * y * y #
Private calls with PIN	#46 SC No. PIN	#46 SC No. PIN	#46 SC No. PIN	#46 SC No. PIN	#46 SC No. PIN	#46 SC No. PIN	#46 SC No. PIN	#46 SC No. PIN	#46 SC No. PIN
Room monitoring (baby listening)									
• Activate x = mode [1&€{3} y = level [1...3] (optional)	–	–	–	–	–	–	*25 x user No. [* y] # ⁴⁾	–	–
• Clear	–	–	–	–	–	–	#25	–	–

Features	Integrated mobile phones ¹⁾	Aastra 6700i SIP series	Other SIP terminals	Aastra 1560 Office 1560 Aastra 2380ip	Office series 25,35,45 Aastra 5300 series	Office 10	Office 135 Office 160 Aastra 600d series	ISDN terminals	Analogue terminals (DTMF)
Trigger Redkey function	*73 Param. #	*73 Param. #	*73 Param. #	*73 Param. #	*73 Param. #	*73 Param. #	*73 Param. #	*73 Param. #	*73 Param. #
Record malicious calls (MCID)	–	–	–	✓	✓	✓	✓	ISDN	–
Ring Alone									
• Activate	*41	*41	*41	*41	*41	*41	*41	*41	*41
• Deactivate	#41	#41	#41	#41	#41	#41	#41	#41	#41
Enquiry									
• To own system	*** user No.	✓	TM					ISDN	R user No.
• To up-circuit system	*** *42 user No.	–	–	l*42 user No.	l*42 user No.	l*42 user No.	l*42 user No.	l*42 user No.	R*42 user No.
Return to the call on hold	***1	✓	TM	 or END	END	END	C key	ISDN	R1
Callback on busy (CCBS) / available (CCNR) user									
• Activate	*** 9 or *** *37	–	–					ISDN	R9 or R*37
• Clear	#37	–	–			#37		#37	#37
Ringling relay with delay (line keys and team keys)	–	–	–	–	0, 10, 20, 30 sec. ³⁾	–	–	–	–
Call Forwarding on No Reply (CFNR)									
• Activate	*61 destination No.	M	*61 destination No.			*61 destination No.		*61 destination No.	*61Destination on No.

Features	Integrated mobile phones ¹⁾	Aastra 6700i SIP series	Other SIP terminals	Aastra 1560 Office 1560 Aastra 2380ip	Office series 25,35,45 Aastra 5300 series	Office 10	Office 135 Office 160 Aastra 600d series	ISDN terminals	Analogue terminals (DTMF)
• to last configured Dest. No.	*61#	M	*61#			*61#		*61#	*61#
• Clear	#61	M	#61			#61		#61	#61
• Activate to preconfigured Dest. No.	*62	*62	*62	*62	*62	*62	*62	*62	*62
• Clear on preconfigured Dest. No.	#62	#62	#62	#62	#62	#62	#62	#62	#62
• Activate on general bell with coded ringing	*68	*68	*68			*68		*68	*68
• Clear to general bell with coded ringing	#68	#68	#68			#68		#68	#68
• Protect against	*02	*02	*02	*02	*02	*02	*02	*02	*02
• Allow to own set	#02	#02	#02	#02	#02	#02	#02	#02	#02
User groups (selectable)									
• Log into all user groups	*4800	*4800	*4800	*4800	*4800	*4800	*4800	*4800	*4800
• Log out of all user groups	#4800	#4800	#4800	#4800	#4800	#4800	#4800	#4800	#4800
• Log into specific user groups	*48 UG No.	*48 UG No.	*48 UG No.	*48 UG No.	*48 UG No.	*48 UG No.	*48 UG No.	*48 UG No.	*48 UG No.
• Log out of specific user groups	#48 UG No.	#48 UG No.	#48 UG No.	#48 UG No.	#48 UG No.	#48 UG No.	#48 UG No.	#48 UG No.	#48 UG No.
Switch over switch groups 01...20									
• Switch group xx in position y (xx = Group [01...20] y = switch pos. [1...3])	*85 xx y	*85 xx y	*85 xx y	*85 xx y	*85 xx y	*85 xx y	*85 xx y	*85 xx y	*85 xx y







Features	Integrated mobile phones ¹⁾	Aastra 6700i SIP series	Other SIP terminals	Aastra 1560 Office 1560 Aastra 2380ip	Office series 25,35,45 Aastra 5300 series	Office 10	Office 135 Office 160 Aastra 600d series	ISDN terminals	Analogue terminals (DTMF)
Control output									
• Activate	*74 <Call number ⁵⁾ >	*74 <Call number ⁵⁾ >	*74 <Call number ⁵⁾ >	*74 <Call number ⁵⁾ >	*74 <Call number ⁵⁾ >	*74 <Call number ⁵⁾ >	*74 <Call number ⁵⁾ >	*74 <Call number ⁵⁾ >	*74 <Call number ⁵⁾ >
• Deactivate	#74 <Call number ⁵⁾ >	#74 <Call number ⁵⁾ >	#74 <Call number ⁵⁾ >	#74 <Call number ⁵⁾ >	#74 <Call number ⁵⁾ >	#74 <Call number ⁵⁾ >	#74 <Call number ⁵⁾ >	#74 <Call number ⁵⁾ >	#74 <Call number ⁵⁾ >
Silent intrusion	***4	–	–	4	4	4	4	–	R4
Subaddressing (SUB)	–	–	–	–	–	–	–	ISDN	–
System time / System date									
• Set up the system time	*57 hh mm	*57 hh mm	*57 hh mm	*57 hh mm	*57 hh mm	*57 hh mm	*57 hh mm	*57 hh mm	*57 hh mm
• Set up the system date	*58 dd mm yyyy	*58 dd mm yyyy	*58 dd mm yyyy	*58 dd mm yyyy	*58 dd mm yyyy	*58 dd mm yyyy	*58 dd mm yyyy	*58 dd mm yyyy	*58 dd mm yyyy
Take	see "Accept a call or data connection with preparation"								
Team keys	–	–	–	✓	✓ ³⁾	–	–	–	–
User-to-user signalling (UUS-1)	–	–	–	–	–	–	–	ISDN	–
Phone lock									
• Lock terminal	*33 PIN #	*33 PIN #	*33 PIN #	✓		*33 PIN #		*33 PIN #	*33 PIN #
• Lock all user's terminals	*33 * PIN #	*33 * PIN #	*33 * PIN #	*33 * PIN #	*33 * PIN #	*33 * PIN #	*33 * PIN #	*33 * PIN #	*33 * PIN #
• Unlock terminal	#33 PIN #	#33 PIN #	#33 PIN #	✓		#33 PIN #		#33 PIN #	#33 PIN #
• Unlock all user's terminals	#33 * PIN #	#33 * PIN #	#33 * PIN #	#33 * PIN #	#33 * PIN #	#33 * PIN #	#33 * PIN #	#33 * PIN #	#33 * PIN #
• Unlock terminal for one call	#36 SC No. PIN	#36 SC No. PIN	#36 SC No. PIN	#36 SC No. PIN	#36 SC No. PIN	#36 SC No. PIN	#36 SC No. PIN	#36 SC No. PIN	#36 SC No. PIN
Appointment call									

Features	Integrated mobile phones ¹⁾	Aastra 6700i SIP series	Other SIP terminals	Aastra 1560 Office 1560 Aastra 2380ip	Office series 25,35,45 Aastra 5300 series	Office 10	Office 135 Office 160 Aastra 600d series	ISDN terminals	Analogue terminals (DTMF)	
• Activate individual call order	–	*55 hh mm	*55 hh mm	*55 hh mm	*55 hh mm	*55 hh mm	*55 hh mm	*55 hh mm	*55 hh mm	
• Activate permanent call order	–	*56 hh mm	*56 hh mm	*56 hh mm	*56 hh mm	*56 hh mm	*56 hh mm	*56 hh mm	*56 hh mm	
• Clear	–	#55 or #56	#55 or #56	#55 or #56	#55 or #56	#55 or #56	#55 or #56	#55 or #56	#55 or #56	
Text messages										
• View	–	–	–			–		–	–	
• Send standard text with / without parameters to user	*3598 SC No. text No. #	*3598 SC No. text No. #	*3598 SC No. text No. #			*3598 SC No. text No. #		*3598 SC No. text No. #	*3598 SC No. text No. #	
• Send standard text with / without parameters to group	*35 Gr. No. text No. #	*35 Gr. No. text No. #	*35 Gr. No. text No. #			*35 Gr. No. text No. #		*35 Gr. No. text No. #	*35 Gr. No. text No. #	
• Send standard text with / without parameters to all	*3599 text No. #	*3599 text No. #	*3599 text No. #			*3599 text No. #		*3599 text No. #	*3599 text No. #	
• Snd user-definable message text	–	–	–	✓	✓	–	✓	–	–	
Open door	*74<No. Door intercom system>	*74<No. Door intercom system>	*74<No. Door intercom system>	*74<No. Door intercom system>	*74<No. Door intercom system>	*74<No. Door intercom system>	*74<No. Door intercom system>	*74<No. Door intercom system>	*74<No. Door intercom system>	
Call door intercom system	✓	✓	✓	✓	✓	✓	✓	✓	✓	
Accept a call or data connection with preparation										

Features	Integrated mobile phones ¹⁾	Aastra 6700i SIP series	Other SIP terminals	Aastra 1560 Office 1560 Aastra 2380ip	Office series 25,35,45 Aastra 5300 series	Office 10	Office 135 Office 160 Aastra 600d series	ISDN terminals	Analogue terminals (DTMF)
<ul style="list-style-type: none"> Prepare to accept a call from nn to mm 	*87 nn*mm#	*87 nn*mm#	*87 nn*mm#	*87 nn*mm#	*87 nn*mm#	*87 nn*mm#	*87 nn*mm#	*87 nn*mm#	*87 nn*mm#
<ul style="list-style-type: none"> Prepare to accept a data connection from nn to mm 	*84 nn*mm#	*84 nn*mm#	*84 nn*mm#	*84 nn*mm#	*84 nn*mm#	*84 nn*mm#	*84 nn*mm#	*84 nn*mm#	*84 nn*mm#
<ul style="list-style-type: none"> Clear preparation for accepting a call from user 	#87 SC No.	#87 SC No.	#87 SC No.	#87 SC No.	#87 SC No.	#87 SC No.	#87 SC No.	#87 SC No.	#87 SC No.
<ul style="list-style-type: none"> Clear preparation for accepting a data connection from user 	#84 SC No.	#84 SC No.	#84 SC No.	#84 SC No.	#84 SC No.	#84 SC No.	#84 SC No.	#84 SC No.	#84 SC No.
<ul style="list-style-type: none"> Activate prepared acceptance 	*88# or *87*88	*88# or *87*88	*88# or *87*88	*88# or *87*88	*88# or *87*88	*88# or *87*88	*88# or *87*88	*88# or *87*88	*88# or *87*88
Acceptance of a call connection or a call without preparation (Fast Take)	*88 SC No.	*88 SC No.	*88 SC No.	*88 SC No.	*88 SC No.	*88 SC No.	*88 SC No.	*88 SC No.	*88 SC No.
Suppress the call number display (CLIR)									
<ul style="list-style-type: none"> Activate permanently 	*31#	*31#	*31#	*31#	*31#	*31#	*31#	*31#	*31#
<ul style="list-style-type: none"> Deactivate permanently 	#31#	#31#	#31#	#31#	#31#	#31#	#31#	#31#	#31#
<ul style="list-style-type: none"> Activate for each call 	*31 destination No.	*31 destination No.	*31 destination No.	*31 destination No.	*31 destination No.	*31 destination No.	*31 destination No.	*31 destination No.	*31 destination No.
<ul style="list-style-type: none"> Deactivate for each call 	#31 destination No.	#31 destination No.	#31 destination No.	#31 destination No.	#31 destination No.	#31 destination No.	#31 destination No.	#31 destination No.	#31 destination No.

Features	Integrated mobile phones ¹⁾	Aastra 6700i SIP series	Other SIP terminals	Aastra 1560 Office 1560 Aastra 2380ip	Office series 25,35,45 Aastra 5300 series	Office 10	Office 135 Office 160 Aastra 600d series	ISDN terminals	Analogue terminals (DTMF)
Hold connection (HOLD)	***	✓	TM					ISDN	R
Voice mail (Basic or Enterprise)									
• Record greeting with phone (x = 1,2,3,7,8)	*913x[*nn] #	*913x[*nn] #	*913x[*nn] #	*913x[*nn] #	*913x[*nn] #	*913x[*nn] #	*913x[*nn] #	*913x[*nn] #	*913x[*nn] #
• Record greeting with audio device (x = 1,2,3,7,8)	*923x[*nn] #	*923x[*nn] #	*923x[*nn] #	*923x[*nn] #	*923x[*nn] #	*923x[*nn] #	*923x[*nn] #	*923x[*nn] #	*923x[*nn] #
• Check recording (x = 1,2,3,7,8)	*#913x[*nn] # or *#923x[*nn] #	*#913x[*nn] # or *#923x[*nn] #	*#913x[*nn] # or *#923x[*nn] #	*#913x[*nn] # or *#923x[*nn] #	*#913x[*nn] # or *#923x[*nn] #	*#913x[*nn] # or *#923x[*nn] #	*#913x[*nn] # or *#923x[*nn] #	*#913x[*nn] # or *#923x[*nn] #	*#913x[*nn] # or *#923x[*nn] #
• Delete recording (x = 1,2,3,7,8)	#913x[*nn] # or #923x[*nn] #	#913x[*nn] # or #923x[*nn] #	#913x[*nn] # or #923x[*nn] #	#913x[*nn] # or #923x[*nn] #	#913x[*nn] # or #923x[*nn] #	#913x[*nn] # or #923x[*nn] #	#913x[*nn] # or #923x[*nn] #	#913x[*nn] # or #923x[*nn] #	#913x[*nn] # or #923x[*nn] #
• Activate greeting (x = 1,2,3)	*933x	*933x	*933x	*933x	*933x	*933x	*933x	*933x	*933x
• Deactivate greeting (x = 1,2,3)	#933x	#933x	#933x	#933x	#933x	#933x	#933x	#933x	#933x
• Listen to voice messages with audio guide	*#94	*#94	*#94	*#94	*#94	*#94	*#94	*#94	*#94
• Listen to voice messages without audio guide	*#916	*#916	*#916	*#916	*#916	*#916	*#916	*#916	*#916
• Signalling of new messages	-	✓	TM	✓	✓	✓	✓	-	-

x = 1,2,3: personal greeting 1,2,3 x = 7: global greeting x = 8: global overflow greeting nn = node No. (optional)

Features	Integrated mobile phones ¹⁾	Aastra 6700i SIP series	Other SIP terminals	Aastra 1560 Office 1560 Aastra 2380ip	Office series 25,35,45 Aastra 5300 series	Office 10	Office 135 Office 160 Aastra 600d series	ISDN terminals	Analogue terminals (DTMF)
Wait until free	see "Callback on busy (CCBS) / available (CCNR) user"								
Answer general bell	see "Coded ringing on generalcall"								
• Coded ringing									
• Ringing signal	*83	*83	*83			*83		*83	*83
Access to system phone book (name / numbers)	–	M	–			–		–	–

1) Mobile phone integration level 2 is required for features introduced with ***.

2) Office 45/45pro and Aastra 5380 only

3) except Office 25 and Aastra 5360/5360ip

4) Aastra 600d and Office 135/135pro only

5) call number assigned to this control output in the numbering plan

Index

Numerics

9d DECT phones 512

A

Abbreviated dialling 48
About this document 16
Accommodation/Hotel 496
ACD 160
Alarm 511
Alarming 511
Allocation table 164
Alternative Routing 215
AMC 56
Analogue down-circuit connection 34
Analogue network interfaces 32
Analogue terminal interfaces 40
Announcement 407
Announcement service 458
Appointment call 440
Audio Guide 386
Authentication 54
Auto Attendant 387
Auto-Attendant 387
Automatic Call Distribution (ACD) 160

B

Baby surveillance 447
Basic access (BA) 20
Basic rate interface BRI-S external 21
Basic voice mail system 382
Break-out 251
Brokering 368

C

Call acceptance 381
Call back 427
Call charge transfer 280
Call data output 283
Call Deflection 232, 349
Call Distribution Element 121
Call Forwarding on No Reply (CFNR) 346
Call Forwarding Unconditional (CFU) 339
Call Forwarding Unconditional if no answer 176
Call Forwarding Unconditional to exchange 342

Call logging 263
Call Logging (CL) 263
Call number display 69
Call transfer 373
Call waiting 400
Calls on a third-party phone 438
Canonical Number 166, 197
Capolinea 149
CD 232
CDE 121
Central call parking 424
CFNR 346
CFU 339
Charge recall 410
CL 263
Class of service 331
CLIP 69, 72, 76, 101
CLIR 77, 468
Clock synchronization 27
CNIP 69
Coded ringing on general bell 455
COLR 77
Conference 371
Configurable key 333
Configuration 465
Control outputs 478
Cost centre 278
Cumulative counter 266

D

Data Protection 278
Data service 255
DDI 118
DECT Follow Me 357
Default diversion per user 176
Deflecting a call 349
Destination table 256
Dialling by name 398
Digit barring 167, 191
Digital down-circuit connection 27
Digital user-network interfaces 36
Direct Dialling In (DDI) 118
Direct Dialling Out (DDO) 28
Direct dialling plan 118
Do not disturb 354

Door function	479
Door intercom system	41
DSI terminal interface	38
DSI terminal interfaces	38
DSS1	205
Duplex mode	412

E

E.164	44
ECT	325, 527
Emergency number	50, 466
Emergency Routing	186
Enquiry	365
Enterprise voice mail system	382
Ethernet interface	41
Exchange Access	48
Exchange access authorization	201, 332
Exchange-to-Exchange Connection	223
External ringing pattern	67

F

Fallback Routing	215
Fast Take	445
Features	320, 519
Follow me	345
Forced Routing	219
Free seating	486
Function key	334
FXO network interface	32
FXS terminal interface	40

G

Gateway-PINX	94
General Bell	42, 150, 455

H

Hold	365
Home alone	473
Hospitality mode	496
Hotel management system	511
Hotline	414

I

ICC	266
ICL	280
Identification elements	67
Incoming Call Logging (ICL)	280
Incoming traffic	168

Individual charge counting (ICC)	266
Individual receipt format	311
Information	420
Integration of mobile phones	52
Interface Ethernet	41
Interface for door intercom system	41
Interface for General Bell	42
Internal Destination	163
Internal ringing pattern	67
Internal users	51
International number format	166, 197
Intrusion	402
Intrusion (silent)	404
IP terminal interface	39
ISDN service	323
ISDN terminal interface	37

K

Key telephone	150
KT line	152

L

Languages	335
Languages supported	335
LCR	206, 466
Least Cost Routing (LCR)	206, 466
Line key	152
Lock phone	433

M

MCID	470
Message and alarm systems	511
Message function	418
Messages	416
Mobile phones	52
Music on hold	362

N

Name display	69
Network Provider	207
Networking	328
Notifications	326
Number key	333
Numbering plan	43

O

OCL	273
Operator console	145

Organise absences	359
Outgoing Call Logging (OCL)	273
Outgoing Traffic	190
Output format	286
Overflow routing	246
Own region prefix	64

P

PARE	326
Park	423
Park function	426
PC output format	311
Periodic reactivation	25
Pick up	413
PISN users	60
PMS	511
PNP	44
Point-to-multipoint connection	22
Point-to-point connection	22
Ports	19
Presence profiles	359
Primary rate access	26
Printer fault	285
Private calls with PIN	439
Product information	12
Property Management System	511
Protocol format	308

R

Recall	379
Recording of malicious calls	470
Regional prefix	64
Regions	64
Reject call	351
Remote control	487
Response if busy	178
Ringing pattern	67
Room monitoring	447
Route	113
Routing element	102
Routing Table	210

S

Safety icons	17
Shared Numbering Plan	64
Signalling from one user to another user	262
Silent intrusion	404
SIP access	29

SIP Provider	29
Special interfaces	41
Standard text	421
Substitution	355
Surcharge calculator	275
Switch group	129, 476
Symbols	17
System interfaces	19

T

Take	444
Taking a call (Take)	444
Team function	432
Team key	334
Terminal interface BRI-S	37
The internal numbering plan	45
Three-party conference	369
Three-Party Connection in the Exchange	234
Time controlled functions	493
Time synchronisation	484
Transfer	373
Transit Routing	237
Trunk groups	106
Twin Mode / Twin Comfort	352
Two-company system	147

U

User categories	51
User configuration	143
User group	132, 141, 472
User information	12
UUS	262

V

Virtual networking	329
Virtual terminals	59
Voice mail mode	383
Voice mail system (basic)	382
Voice mail system (Enterprise)	382
Voice mail system (overview)	382